



# A330/A340

## Flight Crew Training Manual

The content of this document is the property of Airbus. It is supplied in confidence and commercial security on its contents must be maintained. It must not be used for any purpose other than that for which it is supplied, nor may information contained in it be disclosed to unauthorized persons. It must not be reproduced in whole or in part without permission in writing from the owners of the copyright.

© AIRBUS 2002. All rights reserved.

	<b>INTRODUCTION</b>	00.000
	<b>TABLE OF CONTENTS</b>	JAN 09/07

<b>00.010</b>	<b>GENERAL INTRODUCTION</b>	
	- FOREWORDS	1
	- COMMENTS - QUESTIONS - SUGGESTIONS	1
<b>00.030</b>	<b>AIRCRAFT ALLOCATION TABLE</b>	
<b>00.040</b>	<b>LIST OF SECTIONS</b>	
<b>00.070</b>	<b>LIST OF MODIFICATIONS</b>	

	<b>INTRODUCTION</b>	00.010
	GENERAL INTRODUCTION	JAN 09/07

R MSN 0002-0860

### FOREWORDS

The Flight Crew Training Manual (FCTM) is published as a supplement to the Flight Crew Operating Manual (FCOM) and is designed to provide pilots with practical information on how to operate the Airbus A330 and A340 aircraft. It should be read in conjunction with the FCOM. If there is any conflicting information, the FCOM is the overriding reference.

Airline training policy may be different for some sections. If this is the case, the airline training policy is the overriding authority.

R MSN 0002-0860

### COMMENTS - QUESTIONS - SUGGESTIONS

FCTM holders and users are encouraged to submit any questions and suggestions about this manual to:

The following email address:

[fltops.trainingdata@airbus.com](mailto:fltops.trainingdata@airbus.com)

Or, to the following mailing address:

ATTN: Flight Operations Support STLT

1, Rond point Maurice BELLONTE

31707 BLAGNAC CEDEX- FRANCE

<b>01.010</b>	<b>INTRODUCTION</b>	
	- INTRODUCTION	1
	- OPERATIONAL GOLDEN RULES	1
<b>01.020</b>	<b>FLIGHT CONTROLS</b>	
	- INTRODUCTION	1
	- NORMAL LAW	1
	- TWO-ENGINE FAILURE	6
	- ALTERNATE LAW	6
	- DIRECT LAW	7
	- INDICATIONS	8
	- PROTECTIONS	11
	- MECHANICAL BACKUP	17
	- BACKUP	18
	- ABNORMAL ATTITUDES	19
	- SIDESTICK AND PRIORITY P/B	20
<b>01.030</b>	<b>AP / FD / ATHR</b>	
	- AUTOPILOT/FLIGHT DIRECTOR	1
	- AUTOTHRUST (A/THR)	5
	- AP, FD, A/THR MODE CHANGES AND REVERSIONS	12
	- TRIPLE CLICK	16
<b>01.040</b>	<b>ECAM</b>	
	- PURPOSE OF THE ECAM	1
	- MAIN PRINCIPLES	1
	- ECAM HANDLING	3
	- USE OF SUMMARIES	8

	<b>OPERATIONAL PHILOSOPHY</b>	01.010
	INTRODUCTION	JAN 09/07

## INTRODUCTION

R MSN 0002-0860

The Airbus cockpit is designed to achieve pilot operational needs throughout the aircraft operating environment, while ensuring maximum commonality within the Fly by Wire family. The cockpit design objectives are driven by three criteria:

- . Reinforce the safety of flight
- . Improve efficiency of flight
- . Answer pilot requirements in a continuously changing environment

Airbus operational rules result from the design concept, more particularly from the following systems:

- . The **Fly by wire** system with its control laws and protections, commanded through the side stick,
- . An **integrated Auto Flight System** comprising:
  - The FMS interfaced through the MCDU
  - The AP/FD interfaced through the FCU,
  - The A/THR interfaced through the non back driven thrust levers,
  - The FMA, providing Guidance targets and Information, to monitor the AFS
- . A set of **Display units** (DU) providing information and parameters required by the crew
  - To operate and to navigate the aircraft (the EFIS)
  - To communicate (the DCDU)
  - To manage the aircraft systems (the ECAM)
  - FMA interface to provide Guidance targets and information to monitor the AFS/FD
- . A **Forward Facing Cockpit Layout** with "Lights out" or "Dark Cockpit" concept assisting the crew to properly control the various aircraft systems.

The operational rules applicable to these specific features are given in the other sections of this chapter.

## OPERATIONAL GOLDEN RULES

R MSN 0002-0860

1. The aircraft can be flown like any other aircraft

2. Fly, navigate, communicate - in that order
3. One head up at all times
4. Cross check the accuracy of the FMS
5. Know your FMA at all times
6. When things dont go as expected - take over
7. Use the proper level of automation for the task
8. Practice task sharing and back-up each other

	<b>OPERATIONAL PHILOSOPHY</b>  FLIGHT CONTROLS	01.020
		JAN 09/07

## INTRODUCTION

R MSN 0002-0860

The relationship between the Pilot Flying's (PFs) input on the sidestick, and the aircraft's response, is referred to as control law. This relationship determines the handling characteristics of the aircraft.

There are three sets of control laws, and they are provided according to the status of the: Computers, peripherals, and hydraulic generation.

The three sets of control laws are:

- . Normal law
- . Alternate law
- . Direct law.

## NORMAL LAW

R MSN 0002-0860

### OBJECTIVES

The aim of normal law is to provide the following handling characteristics within the normal flight envelope (regardless of aircraft speed, altitude, gross weight and CG):

- . Aircraft must be stable and maneuverable
- . The same response must be consistently obtained from the aircraft
- . The Actions on the sidestick must be balanced in pitch and in roll.

The normal law handling characteristics, at the flight envelope limit are:

- . The PF has full authority to achieve Maximum aircraft Performance
- . The PF can have instinctive/immediate reaction, in the event of an emergency
- . There is a reduced possibility of overcontrolling or overstressing the aircraft.

Normal Law is the law that is most commonly available, and it handles single failures.

	<b>OPERATIONAL PHILOSOPHY</b>	01.020
	<b>FLIGHT CONTROLS</b>	JAN 09/07

## CHARACTERISTICS IN PITCH

### IN FLIGHT

When the PF performs sidestick inputs, a constant G-load maneuver is ordered, and the aircraft responds with a G-Load/Pitch rate. Therefore, the PFs order is consistent with the response that is "naturally" expected from the aircraft: Pitch rate at low speed; Flight Path Rate or G, at high speed.

So, if there is no input on the stick:

- . The aircraft maintains the flight path, even in case of speed changes
- . In case of configuration changes or thrust variations, the aircraft compensates for the pitching moment effects
- . In turbulence, small deviations occur on the flight path. However, the aircraft tends to regain a steady condition.

### AIRBUS PITCH CHARACTERISTIC

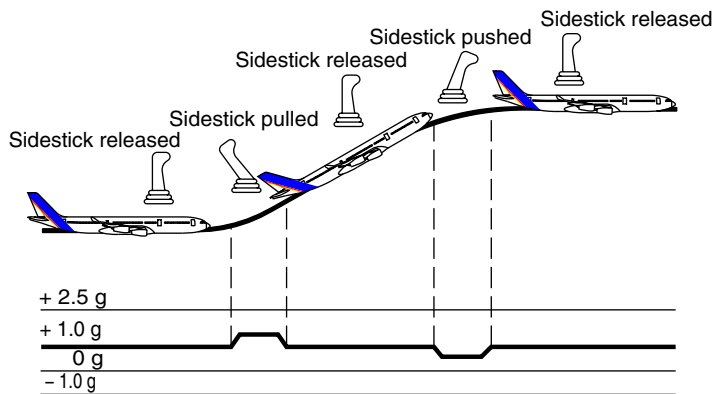

FOF 01020 03732 0001

### **Operational Recommendation:**

Since the aircraft is stable and auto-trimmed, the PF needs to perform minor corrections on the sidestick, if the aircraft deviates from its intended flight path.

The PF should not fight the sidestick, or overcontrol it. If the PF senses an overcontrol, the sidestick should be released.

### **AT TAKEOFF AND LANDING**



	<b>OPERATIONAL PHILOSOPHY</b>	01.020
	FLIGHT CONTROLS	JAN 09/07

The above-mentioned pitch law is not the most appropriate for takeoff and flare, because the stable flight path is not what the PF naturally expects. Therefore, the computers automatically adapt the control laws to the flight phases:

- . GROUND LAW: The control law is direct law
- . FLARE LAW: The control law is a smoother direct law.

**Operational Recommendation:**

Takeoff and landing maneuvers are naturally achieved. For example, a flare requires the PF to apply permanent aft pressure on the sidestick, in order to achieve a progressive flare. Whereas, derotation consists of smoothly flying the nosegear down, by applying slight aft pressure on the sidestick.

**LATERAL CHARACTERISTICS**

**NORMAL CONDITIONS**

When the PF performs a lateral input on the sidestick, a roll rate is ordered and naturally obtained.

Therefore, at a bank angle of less than 33 degrees, with no input on the sidestick, a zero roll rate is ordered, and the current bank angle is maintained. Consequently, the aircraft is laterally stable, and no aileron trim is required.

However, lateral law is also a mixture of roll and yaw demand with:

- Automatic turn coordination
- Automatic yaw damping
- Initial yaw damper response to a major aircraft assymetry.

In addition, if the bank angle is less than 33 degrees, pitch compensation is provided.

If the bank angle is greater than 33 degrees, spiral stability is reintroduced and pitch compensation is no longer available. This is because, in normal situations, there is no operational reason to fly with such high bank angles for a long period of time.

**AIRBUS LATERAL CHARACTERISTIC**

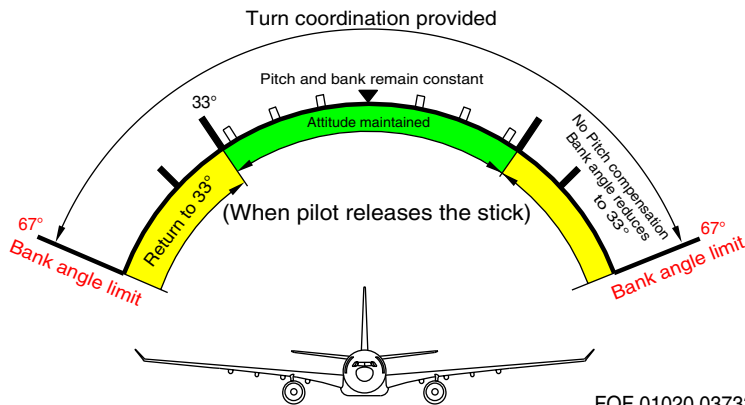

### Operational Recommendation:

During a normal turn (bank angle less than 33 degrees), in level flight:

- . The PF moves the sidestick laterally (the more the sidestick is moved laterally, the greater the resulting roll rate - e.g. 15 degrees/second at max deflection)
- . Not necessary to make a pitch correction
- . Not necessary to use the rudder.

In the case of steep turns (bank angle greater than 33 degrees), the PF must apply:

- . Lateral pressure on the sidestick to maintain bank
- . Aft pressure on the sidestick to maintain level flight.

### ENGINE FAILURE

In flight, if an engine failure occurs, and no input is applied on the sidestick, lateral normal law controls the natural tendency of the aircraft to roll and yaw.

If no input is applied on the sidestick, the aircraft will reach an approximate 5-degree constant bank angle, a constant sideslip, and a slowly-diverging heading rate.

The lateral behavior of aircraft is safe.

However, the PF is best suited to adapt the lateral trimming technique, when necessary. From a performance standpoint, the most effective flying technique, in

	<b>OPERATIONAL PHILOSOPHY</b>  FLIGHT CONTROLS	01.020
		JAN 09/07

the event of an engine failure at takeoff, is to fly a constant heading with roll surfaces retracted. This technique dictates the amount of rudder that is required, and the resulting residual sideslip.

As a result, to indicate the amount of rudder that is required to correctly fly with an engine-out at takeoff, the measured sideslip index is shifted on the PFD by the computed, residual-sideslip value. This index appears in blue, instead of in yellow, and is referred to as the beta target. If the rudder pedal is pressed to center the beta target index, the PF will fly with the residual slip, as required by the engine-out condition. Therefore, the aircraft will fly at a constant heading with ailerons and spoilers close to neutral position.

#### BETA TARGET ON PFD

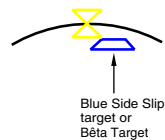

FOF 01020 03734 0001

#### **Operational Recommendation:**

In the case of an engine failure at takeoff, the PF must:

- . Smoothly adjust pitch to maintain a safe speed (as per SRS guidance)
- . Center the Beta target (there is no hurry, because the aircraft is laterally safe)
- . When appropriate, trim the aircraft laterally using the rudder trim
- . Apply small lateral sidestick inputs, so that the aircraft flies the appropriate heading.

#### **AVAILABLE PROTECTIONS**

Normal Law provides five different protections (Refer to the "Protections" paragraph):

- . High angle-of-attack protection
- . Load factor protection
- . High pitch attitude protection
- . Bank angle protection
- . High speed protection.

**TWO-ENGINE FAILURE**

R MSN 0002-0011 0013-0016 0018-0029 0031-0035 0038-0044 0046-0049 0051-0053 0056-0058  
 0061 0063 0074-0076 0078-0081 0084-0085 0088-0094 0097 0101 0103-0104 0114-0115 0117  
 0123-0126 0128-0131 0133-0137 0139 0141-0142 0145-0147 0149-0152 0154 0156-0161  
 0163-0164 0166-0170 0173-0176 0178-0180 0182 0185-0187 0190 0192-0194 0196-0197 0199  
 0201-0202 0204 0207-0208 0210 0212-0218 0220-0221 0225 0227-0228 0233 0235-0237  
 0239 0242-0243 0245-0246 0252 0257 0260 0263-0264 0268 0270 0273-0274 0278 0280  
 0282 0292 0297 0302 0304 0307 0310 0318-0319 0321 0325 0327 0329 0331-0332  
 0335 0347 0352 0354-0355 0359 0363 0367 0371 0373-0374 0376-0379 0381 0383 0385  
 0387 0390-0391 0394-0395 0399 0402 0406 0410-0411 0413-0417 0424 0426 0429-0431  
 0433-0436 0438 0440 0442 0445-0447 0449-0450 0453 0457 0459-0460 0464 0467-0468  
 0470-0471 0474-0475 0478 0482-0483 0485 0488 0492 0495 0499 0514 0517 0520 0523  
 0528 0531 0534 0537-0538 0540-0541 0543-0547 0554 0556-0557 0559-0563 0566 0569  
 0572 0575 0577 0580 0582-0583 0585-0586 0590 0598 0601 0604 0606 0608 0611 0615  
 0617 0619 0622 0624 0626 0628 0630 0639 0643 0646 0651 0668 0672 0677 0681 0685  
 0689 0694 0698 0702 0706 0710 0715 0719 0723 0727 0731 0736 0740 0744 0748 0753  
 0757 0761-0768 0771 0775 0779 0783 0787 0790 0793-0794 0798 0800 0804 0812 0829  
 0835 0837 0844 0846 0848

In the case of a two-engine failure during go-around, the aircraft speed will most probably be below VMCL-2. In this case, even with full rudder pedal, the PF will not be able to center the Beta Target, because the rudder is less efficient at such a low speed. This is a good indication that the PF should accelerate. Furthermore, this indication is enhanced by a VLS increase on the PFD, and by a pitch down order of the FD bars in SRS mode.

R MSN 0002-0860

**ALTERNATE LAW**

In some double failure cases, the integrity and redundancy of the computers and of the peripherals are not sufficient to achieve normal law and associated protections. System degradation is progressive, and will evolve according to the availability of remaining peripherals or computers.

In addition, depending on the type of failure, the control law may either be Alternate 1 or Alternate 2.

Alternate law characteristics (usually triggered in case of a dual failure):

	<b>OPERATIONAL PHILOSOPHY</b>	01.020
	FLIGHT CONTROLS	JAN 09/07

- . In pitch: Same as in normal law
- . In roll: Same as in normal law (ALTN1), or Roll Direct (ALTN2)
- . In yaw: Same as in normal law (ALTN1), or degraded (ALTN2)
- . Most protections are lost, except :
  - Load factor protection
  - Bank angle protection, if normal roll is still available (ALTN1 only).

At the flight envelope limit, the aircraft is not protected:

- . In high speed, natural aircraft static stability is restored with an overspeed warning
- . In low speed, the auto pitch trim stops at Vc prot (below VLS), and natural longitudinal static stability is restored, with a stall warning at 1.03 VS1g.

In certain failure cases, such as the loss of VS1g computation or the loss of two ADRs, the longitudinal static stability cannot be restored at low speed. In the case of a loss of three ADRs, it cannot be restored at high speed.

In alternate law, VMO/MMO settings are reduced (see ECAM indications here after), and A FLOOR is inhibited.

**Operational Recommendation:**

The handling characteristics within the normal flight envelope, are identical in pitch with normal law.

Outside the normal flight envelope, the PF must take appropriate preventive actions to avoid losing control, and/or avoid high speed excursions. These actions are the same as those that would be applied in any case where non protected aircraft (e.g. in case of stall warning: add thrust, reduce pitch, check speedbrakes retracted).

**DIRECT LAW**

R MSN 0002-0860

In most triple failure cases, direct law triggers. When this occurs:

- . Elevator deflection is proportional to stick deflection. Maximum deflection depends on the configuration and on the CG
- . Aileron and spoiler deflections are proportional to stick deflection, but vary with the aircraft configuration

	<b>OPERATIONAL PHILOSOPHY</b>  <b>FLIGHT CONTROLS</b>	01.020
		JAN 09/07

- . Pitch trim is commanded manually
- . Yaw damper and minimum turn coordination are provided.

Handling characteristics are natural, of high-quality aircraft, almost independent of the configuration and of the CG. Therefore, the aircraft obviously has no protections, no automatic pitch trim, but overspeed or stall warnings.

**Operational Recommendation:**

The PF must avoid performing large thrust changes, or sudden speedbrake movements, particularly if the center of gravity is aft. If the speedbrakes are out, and the aircraft has been re-trimmed, the PF must gently retract the speedbrakes, to give the aircraft time to retrim, and thereby avoid a large, nose-down trim change.

**INDICATIONS**

R MSN 0002-0011 0013-0016 0018-0029 0031-0035 0038-0044 0046-0049 0051-0053 0056-0058  
0061 0063 0074-0076 0078-0081 0084-0085 0088-0094 0097 0101 0103-0104 0114-0115 0117  
0123-0126 0128-0131 0133-0137 0139 0141-0142 0145-0147 0149-0152 0154 0156-0161  
0163-0164 0166-0170 0173-0176 0178-0180 0182 0185-0187 0190 0192-0194 0196-0197 0199  
0201-0202 0204 0207-0208 0210 0212-0218 0220-0221 0225 0227-0228 0233 0235-0237  
0239 0242-0243 0245-0246 0252 0257 0260 0263-0264 0268 0270 0273-0274 0278 0280  
0282 0292 0297 0302 0304 0307 0310 0318-0319 0321 0325 0327 0329 0331-0332  
0335 0347 0352 0354-0355 0359 0363 0367 0371 0373-0374 0376-0379 0381 0383 0385  
0387 0390-0391 0394-0395 0399 0402 0406 0410-0411 0413-0417 0424 0426 0429-0431  
0433-0436 0438 0440 0442 0445-0447 0449-0450 0453 0457 0459-0460 0464 0467-0468  
0470-0471 0474-0475 0478 0482-0483 0485 0488 0492 0495 0499 0514 0517 0520 0523  
0528 0531 0534 0537-0538 0540-0541 0543-0547 0554 0556-0557 0559-0563 0566 0569  
0572 0575 0577 0580 0582-0583 0585-0586 0590 0598 0601 0604 0606 0608 0611 0615  
0617 0619 0622 0624 0626 0628 0630 0639 0643 0646 0651 0668 0672 0677 0681 0685  
0689 0694 0698 0702 0706 0710 0715 0719 0723 0727 0731 0736 0740 0744 0748 0753  
0757 0761-0768 0771 0775 0779 0783 0787 0790 0793-0794 0798 0800 0804 0812 0829  
0835 0837 0844 0846 0848

The ECAM and PFD indicate any control law degradation.

**On the ECAM**

In Alternate Law:

FLT CTL ALTN LAW (PROT LOST)

MAX SPEED 305/.82

	<b>OPERATIONAL PHILOSOPHY</b>  <b>FLIGHT CONTROLS</b>	01.020
		JAN 09/07

In Direct Law:

**FLT CTL DIRECT LAW (PROT LOST)**

MAX SPEED 305/.80

MAN PITCH TRIM USE

**On the PFD**

The PFD enhances the PF's awareness of the status of flight controls.

Specific symbols (= in green), and specific formatting of low speed information on the speed scale in normal law, indicate which protections are available.

When protections are lost, amber crosses (XXX) appear, instead of the green protection symbols (=).

When automatic pitch trim is no longer available, the PFD indicates this with an amber USE MAN PITCH TRIM" message below the FMA.

**FLY-BY-WIRE STATUS AWARENESS VIA THE PFD**

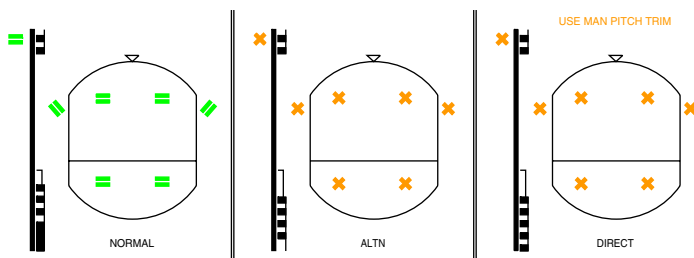

FOF 01020 03762 0001

Therefore, by simply looking at this main instrument (PFD), the flight crew is immediately aware of the status of flight controls, and the operational consequences.

	<b>OPERATIONAL PHILOSOPHY</b>  <b>FLIGHT CONTROLS</b>	01.020
		JAN 09/07

R MSN 0012 0017 0030 0037 0045 0050 0054-0055 0059-0060 0062 0064-0073 0077  
0082-0083 0086-0087 0095-0096 0098-0100 0102 0106-0113 0116 0118-0122 0127 0132 0138  
0140 0143-0144 0148 0153 0155 0162 0165 0171-0172 0177 0181 0183-0184 0188-0189  
0191 0195 0198 0200 0203 0205-0206 0209 0211 0219 0222-0224 0226 0229-0232 0234  
0238 0240-0241 0244 0247-0251 0253-0256 0258-0259 0261-0262 0265-0267 0269 0271-0272  
0275-0277 0279 0281 0283-0291 0293-0296 0299-0301 0303 0305-0306 0308-0309 0311-0317  
0320 0322-0324 0326 0328 0330 0333-0334 0337-0346 0348-0351 0353 0356-0358 0361-0362  
0364-0366 0368-0370 0372 0375 0380 0382 0384 0386 0388-0389 0392-0393 0396-0398  
0400-0401 0403-0405 0407-0409 0412 0418-0423 0425 0427-0428 0432 0437 0439 0441  
0443-0444 0448 0451-0452 0454-0456 0458 0461-0463 0465-0466 0469 0472-0473 0476-0477  
0479-0481 0484 0486-0487 0489-0491 0493-0494 0496-0498 0500-0513 0515-0516 0518-0519  
0521-0522 0524-0527 0529-0530 0532-0533 0535-0536 0539 0542 0548-0553 0555 0558  
0564-0565 0567-0568 0570-0571 0573-0574 0576 0578-0579 0581 0584 0587-0588 0591-0597  
0600 0602-0603 0605 0607 0609-0610 0612-0614 0616 0618 0620-0621 0623 0625 0627  
0629 0631-0638 0640-0642 0644-0645 0647-0650 0652-0667 0669-0671 0673-0676 0678-0680  
0682-0684 0686-0688 0690-0693 0695-0697 0699-0701 0703-0705 0707-0709 0711-0714  
0716-0718 0720-0722 0724-0726 0728-0730 0732-0735 0737-0739 0741-0743 0745-0747  
0749-0752 0754-0756 0758-0760 0769-0770 0772-0774 0776-0778 0780-0782 0784-0786  
0788-0789 0791-0792 0795-0797 0799 0801-0803 0805-0811 0813-0828 0830-0834 0836  
0838-0843 0845 0847 0849-0860

The ECAM and PFD indicate any control law degradation.

**On the ECAM**

In Alternate Law:

FLT CTL ALTN LAW (PROT LOST)

MAX SPEED 330/.82

In Direct Law:

FLT CTL DIRECT LAW (PROT LOST)

MAX SPEED 330/.80

MAN PITCH TRIM USE

**On the PFD**

The PFD enhances the PF's awareness of the status of flight controls.

Specific symbols (= in green), and specific formatting of low speed information on the speed scale in normal law, indicate which protections are available.

When protections are lost, amber crosses (XXX) appear, instead of the green protection symbols (=).

When automatic pitch trim is no longer available, the PFD indicates this with an amber USE MAN PITCH TRIM" message below the FMA.



FLY-BY-WIRE STATUS AWARENESS VIA THE PFD

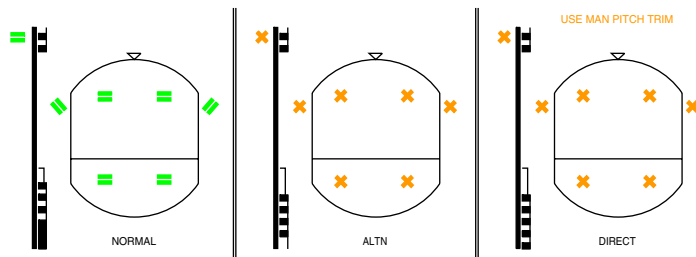

FOF 01020 03762 0001

Therefore, by simply looking at this main instrument (PFD), the flight crew is immediately aware of the status of flight controls, and the operational consequences.

**PROTECTIONS**

R MSN 0002-0860

**OBJECTIVES**

One of the PF's primary tasks is to maintain the aircraft within the limits of the normal flight envelope. However, some circumstances, due to extreme situations or aircraft mishandling, may provoke the violation of these limits.

Despite system protections, the PF must not deliberately exceed the normal flight envelope. In addition, these protections are not designed to be structural limit protections (e.g. opposite rudder pedal inputs). Rather, they are designed to assist the PF in emergency and stressful situations, where only instinctive and rapid reactions will be effective.

Protections are intended to:

- . Provide full authority to the PF to consistently achieve the best possible aircraft performance in extreme conditions
- . Reduce the risks of overcontrolling, or overstressing the aircraft
- . Provide PF with an instinctive and immediate procedure to ensure that the PF achieves the best possible result.

	<b>OPERATIONAL PHILOSOPHY</b>	01.020
	<b>FLIGHT CONTROLS</b>	JAN 09/07

### **BANK ANGLE PROTECTION**

Bank angle protection prevents that any major upset, or PF mishandling, causes the aircraft to be in a high-bank situation (wherein aircraft recovery is complex, due to the difficulty to properly assess such a situation and readily react). Bank angle protection provides the PF with full authority to efficiently achieve any required roll maneuver.

The maximum achievable bank angle is plus or minus:

- . 67 degrees, within the Normal Flight envelope (2.5 g level flight)
- . 45 degrees, in high AOA protection or high speed protection.

### **HIGH SPEED PROTECTION**

When flying beyond maximum design speeds VD/MD (which are greater than VMO/MMO), there is an increased potential for aircraft control difficulties and structural concerns, due to high air loads. Therefore, the margin between VMO/MMO and VD/MD must be such that any possible overshoot of the normal flight envelope should not cause any major difficulty.

High speed protection adds a positive nose-up G demand to a sidestick order, in order to protect the aircraft, in the event of a dive or vertical upset. As a result, this enables a reduction in the margin between VMO/MMO and VD/MD.

Therefore, in a dive situation:

- . If there is no sidestick input on the sidestick, the aircraft will slightly overshoot VMO/MMO and fly back towards the envelope.
- . If the sidestick is maintained full forward, the aircraft will significantly overshoot VMO/MMO without reaching VD/MD. At approximately  $VMO + 16 / MMO + 0.04$ , the pitch nose-down authority smoothly reduces to zero (which does not mean that the aircraft stabilizes at that speed).

#### **AIRBUS HIGH SPEED PROTECTION**

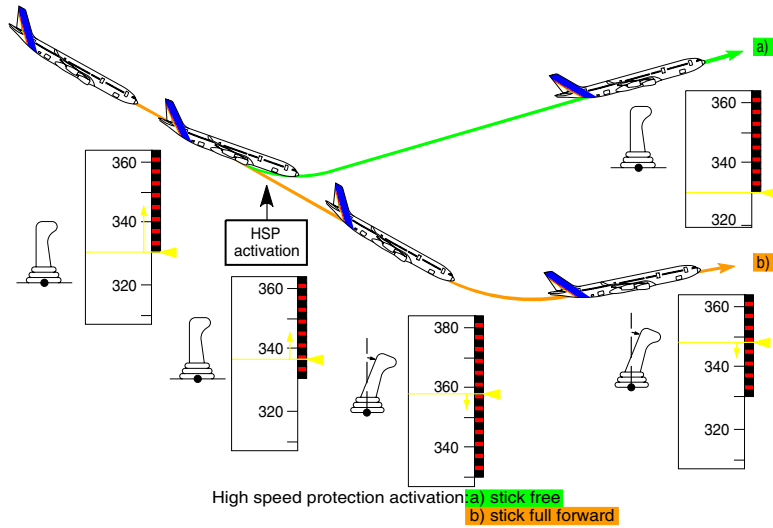

FOF 01020 03735 0001

The PF, therefore, has full authority to perform a high speed/steep dive escape maneuver, when required, via a reflex action on the sidestick. In addition, the bank angle limit is reduced from 67 to 40 degrees, which minimizes the risk of a spiral dive.

Note:

1. An **OVERSPEED** warning is provided.
2. At high altitude, this may result in activation of the angle of attack protection.

**LOAD FACTOR PROTECTION**

On commercial aircraft, high load factors can be encountered during evasive maneuvers due to potential collisions, or CFIT

Pulling "g" is efficient, if the resulting maneuver is really flown with this "g" number. If the aircraft is not able to fly this trajectory, or to perform this maneuver, pulling "g" will be detrimental.

On commercial aircraft, the maximum load that is structurally allowed is:

- . 2.5 g in clean configuration,
- . 2.0 g with the flaps extended.

AIRBUS LOAD FACTOR PROTECTION AND SAFETY

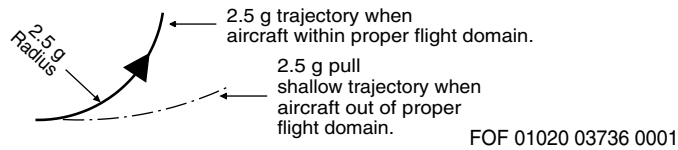

On most commercial aircraft, the potential for an efficient 2.5 g maneuver is very remote. Furthermore, as G Load information is not continuously provided in the cockpit, airline PFs are not used to controlling this parameter. This is further evidenced by inflight experience, which reveals that: In emergency situations, initial PF reaction on a yoke or sidestick is hesitant, then aggressive.

With load factor protection, the PF may immediately and instinctively pull the sidestick full aft: The aircraft will initially fly a 2.5 g maneuver without losing time. Then, if the PF still needs to maintain the sidestick full aft stick, because the danger still exists, then the high AOA protection will take over. Load factor protection enhances this high AOA protection.

Load factor protection enables immediate PF reaction, without any risk of overstressing the aircraft.

Flight experience has also revealed that an immediate 2.5 g reaction provides larger obstacle clearance, than a hesitant and delayed high G Load maneuver (two-second delay).

**HIGH PITCH ATTITUDE PROTECTION**

Excessive pitch attitudes, caused by upsets or inappropriate maneuvers, lead to hazardous situations:

- . Too high a nose-up ► Very rapid energy loss
- . Too low a nose-down ► Very rapid energy gain

Furthermore, there is no emergency situation that requires flying at excessive attitudes. For these reasons, pitch attitude protection limits pitch attitude to plus 30 degrees/minus 15 degrees.

Pitch attitude protection enhances high speed protection, high load factor protection, and high AOA protection.

**HIGH ANGLE-OF-ATTACK (AOA) PROTECTION**

High AOA protection enables the PF to pull the sidestick full aft in dangerous situations, and thus consistently achieve the best possible aircraft lift. This

action on the sidestick is instinctive, and the high AOA protection minimizes the risk of stalls or control loss.

High AOA protection is an aerodynamic protection:

- . The PF will notice if the normal flight envelope is exceeded for any reason, because the autopitch trim will stop, the aircraft will sink to maintain its current AOA (alpha PROT, strong static stability), and a significant change in aircraft behavior will occur.
- . If the PF then pulls the sidestick full aft, a maximum AOA (approximately corresponding to CL Max) is commanded. In addition, the speedbrakes will automatically retract, if extended.

AIRBUS AOA PROTECTION

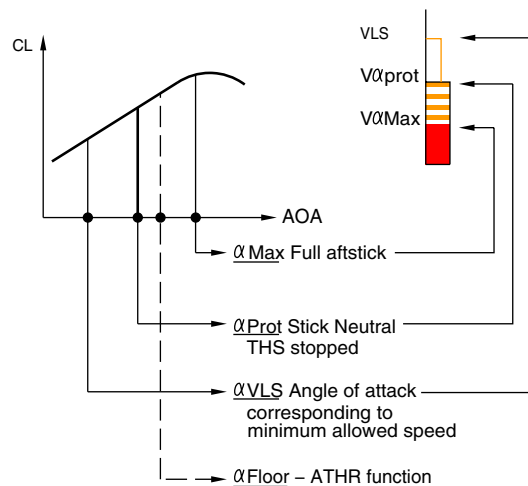

FOF 01020 03737 0001

In addition to this aerodynamic protection, there are three more energy features:

- . If ATHR is in SPEED mode, the speed cannot drop below VLS, even if the target speed is below VLS
- . A "LOW ENERGY" aural alert triggers, when the aircraft energy level drops below a specific threshold function of, for example, IAS, ACCEL/DECEL, or FPA.

For example, if the aircraft decelerates at 1 kt/sec, and:

- The FPA is -3 degrees, the alert will trigger at approximately VLS -8,

	<b>OPERATIONAL PHILOSOPHY</b>	01.020
	<b>FLIGHT CONTROLS</b>	JAN 09/07

– The FPA is -4 degrees, the alert will trigger at approximately VLS -2. This "SPEED, SPEED, SPEED" alert draws the PF's attention to the SPEED scale, and indicates the need to adjust thrust.

It comes immediately before the ALPHA Floor, and is available when the aircraft is below 2000 feet RA and is in CONF  $\geq$  2.

- . If the angle-of-attack still increases and reaches ALPHA Floor threshold, the A/THR triggers TOGA thrust and engages (unless in some cases of one engine-out).

In case of an emergency situation, such as Windshear or CFIT, the PF is assisted in order to optimize aircraft performance via the:

- . A/THR: Adds thrust to maintain the speed above VLS
- . Low Energy Speed Speed warning: Enhances PF awareness
- . ALPHA FLOOR: Provides TOGA thrust
- . HIGH AOA protection: Provides maximum aerodynamic lift
- . Automatic speedbrake retraction: Minimizes drag.

**Operational Recommendations:**

When flying at alpha max, the PF can make gentle turns, if necessary.

The PF must not deliberately fly the aircraft in alpha protection, except for brief periods, when maximum maneuvering speed is required.

If alpha protection is inadvertently entered, the PF must exit it as quickly as possible, by easing the sidestick forward to reduce the angle-of-attack, while simultaneously adding power (if alpha floor has not yet been activated, or has been cancelled). If alpha floors has been triggered, it must be cancelled with the disconnect pushbutton (on either thrust lever), as soon as a safe speed is resumed.

In case of GPWS/SHEAR:

- . Set the thrust levers to TOGA
- . Pull the sidestick to full aft (For shear, fly the SRS, until full aft sidestick).
- . Initially maintain the wings level

This immediately provides maximum lift/maximum thrust/minimum drag. Therefore, CFIT escape maneuvers will be much more efficient.

CFIT ESCAPE MANOEUVRES ON PROTECTED AND NON PROTECTED AIRCRAFT

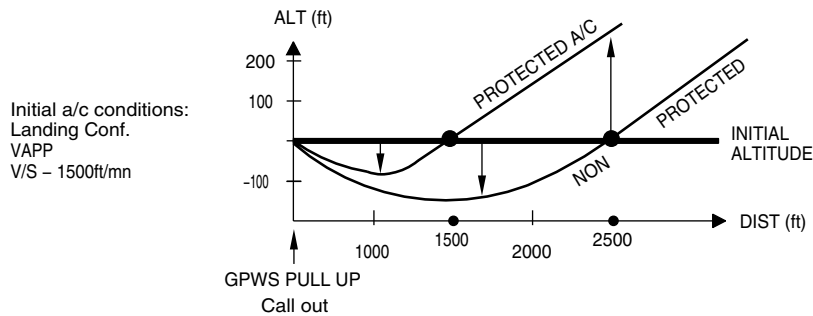

FOF 01020 03738 0001

The above-illustrated are typical trajectories flown by all protected or not protected aircraft, when the PF applies the escape procedure after an aural "GPWS PULL UP" alert.

The graph demonstrates the efficiency of the protection, to ensure a duck-under that is 50 percent lower, a bucket-distance that is 50 percent shorter, a safety margin that more than doubles (due to a quicker reaction time), and a significant altitude gain ( $\pm 250$  ft). These characteristics are common to all protected aircraft, because the escape procedure is easy to achieve, and enables the PF to fly the aircraft at a constant AOA, close to the max AOA. It is much more difficult to fly the stick shaker AOA on an aircraft that is not protected.

**MECHANICAL BACKUP**

MSN 0002-0370 0372-0375 0377-0382 0384-0390 0392-0393 0395-0409 0411-0415 0418-0425  
 0427-0430 0432-0435 0437-0439 0441-0444 0446-0448 0450-0452 0454-0456 0458-0459  
 0461-0463 0465-0467 0469-0470 0472-0474 0476-0477 0479-0481 0483-0484 0486-0487  
 0489-0491 0493-0494 0496-0498 0500-0513 0515-0516 0518-0519 0521-0522 0525-0530  
 0532 0535-0536 0538-0539 0541 0545-0546 0548 0550-0551 0554 0556 0559 0561-0562  
 0565 0567-0568 0581 0584 0597 0627 0635 0657 0660

The purpose of the **mechanical** backup is to achieve all safety objectives in MMEL dispatch condition: To manage a temporary and total electrical loss, the temporary loss of five fly-by-wire computers, the loss of both elevators, or the total loss of ailerons and spoilers.

	<b>OPERATIONAL PHILOSOPHY</b>	01.020
	<b>FLIGHT CONTROLS</b>	JAN 09/07

It must be noted that it is very unlikely the **mechanical** backup will be used, due to the fly-by-wire architecture. For example, in case of electrical emergency configuration, or an all-engine flameout, alternate law remains available.

In the unlikely event of such a failure, **mechanical** backup enables the PF to safely stabilize the aircraft, using the rudder and manual pitch trim, while reconfiguring the systems.

In such cases, the objective is not to fly the aircraft accurately, but to maintain the aircraft attitude safe and stabilized, in order to allow the restoration of lost systems.

The pitch trim wheel is used to control pitch. Any action on the pitch trim wheel should be applied smoothly, because the THS effect is significant due to its large size.

The rudder provides lateral control, and induces a significant roll with a slight delay. The PF should apply some rudder to turn, and wait for the aircraft reaction. To stabilize and level the wings, anticipate by releasing the rudder pedals.

A red "MAN PITCH TRIM ONLY" message appears on the PFD to immediately inform the PF that the mechanical backup is being used.

BACK-UP INDICATION ON PFD

**MAN PITCH TRIM ONLY**

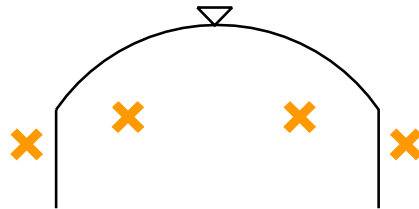

FOF 01020 03740 0001

**BACKUP**

R MSN 0371 0376 0383 0391 0394 0410 0416-0417 0426 0431 0436 0440 0445 0449 0453  
0457 0460 0464 0468 0471 0475 0478 0482 0485 0488 0492 0495 0499 0514 0517 0520  
0523-0524 0531 0533-0534 0537 0540 0542-0544 0547 0549 0552-0553 0555 0557-0558  
0560 0563-0564 0566 0569-0580 0582-0583 0585-0595 0598-0626 0628-0634 0636-0656  
0658-0659 0661-0860



	<b>OPERATIONAL PHILOSOPHY</b>  <b>FLIGHT CONTROLS</b>	01.020
		JAN 09/07

The purpose of the backup is to achieve all safety objectives in MMEL dispatch condition: To manage a temporary and total electrical loss, the temporary loss of five fly-by-wire computers, the loss of both elevators, or the total loss of ailerons and spoilers.

It must be noted that it is very unlikely the backup will be used, due to the fly-by-wire architecture. For example, in case of electrical emergency configuration, or an all-engine flameout, alternate law remains available.

In the unlikely event of such a failure, backup enables the PF to safely stabilize the aircraft, using the rudder and manual pitch trim, while reconfiguring the systems.

In such cases, the objective is not to fly the aircraft accurately, but to maintain the aircraft attitude safe and stabilized, in order to allow the restoration of lost systems.

The pitch trim wheel is used to control pitch. Any action on the pitch trim wheel should be applied smoothly, because the THS effect is significant due to its large size.

The rudder provides lateral control, and induces a significant roll with a slight delay. The PF should apply some rudder to turn, and wait for the aircraft reaction. To stabilize and level the wings, anticipate by releasing the rudder pedals.

A red "MAN PITCH TRIM ONLY" message appears on the PFD to immediately inform the PF that the backup is being used.

BACK-UP INDICATION ON PFD

**MAN PITCH TRIM ONLY**

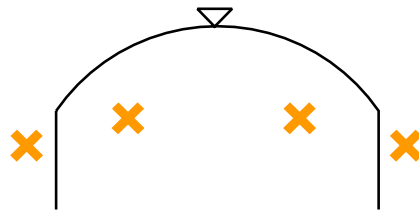

FOF 01020 03740 0001

**ABNORMAL ATTITUDES**

R MSN 0002-0860

	<b>OPERATIONAL PHILOSOPHY</b>	01.020
	<b>FLIGHT CONTROLS</b>	JAN 09/07

If the aircraft is, for any reason, far outside the normal flight envelope and reaches an abnormal attitude, the normal controls are modified and provide the PF with maximum efficiency in regaining normal attitudes. (An example of a typical reason for being far outside the normal flight envelope would be a mid-air collision).

The so-called "abnormal attitude" law is :

- . Pitch alternate with load factor protection (without autotrim)
- . Lateral direct law with yaw alternate

These laws trigger, when extreme values are reached:

- . Pitch (50 degrees up, 30 degrees down)
- . Bank (125 degrees)
- . AOA (30 degrees, -10 degrees)
- . Speed (440 kt, 60 kt)
- . Mach (0.96, 0.1).

It is very unlikely that the aircraft will reach these attitudes, because fly-by-wire provides protection to ensure rapid reaction far in advance. This will minimize the effect and potential for such aerodynamic upsets.

The effectiveness of fly-by-wire architecture, and the existence of control laws, eliminate the need for upset recovery maneuvers to be trained on protected Airbus aircraft.

### SIDESTICK AND PRIORITY P/B

R MSN 0002-0860

When the Pilot Flying (PF) makes an input on the sidestick, an order (an electrical signal) is sent to the fly-by-wire computer. If the Pilot Not Flying (PNF) also acts on the stick, then both signals/orders are added.

Therefore, as on any other aircraft type, PF and PNF must not act on their sidesticks at the same time. If the PNF (or Training Captain) needs to take over, the PNF must press the sidestick priority pushbutton, and announce: "I have control".

	<b>OPERATIONAL PHILOSOPHY</b>	01.020
	<b>FLIGHT CONTROLS</b>	JAN 09/07

If a flight crewmember falls on a sidestick, or a mechanical failure leads to a jammed stick (there is no associate ECAM caution), the "failed" sidestick order is added to the "non failed" sidestick order.

In this case, the other not affected flight crewmember must press the sidestick priority pushbutton for at least 40 seconds, in order to deactivate the "failed" sidestick.

A pilot can at any time reactivate a deactivated stick by momentarily pressing the takeover push button on either stick.

In case of a "SIDE STICK FAULT" ECAM warning, due to an electrical failure, the affected sidestick order (sent to the computer) is forced to zero. This automatically deactivates the affected sidestick. This explains why there is no procedure associated with that warning.

	<b>OPERATIONAL PHILOSOPHY</b>  AP / FD / ATHR	01.030
		JAN 09/07

**AUTOPILOT/FLIGHT DIRECTOR**

R MSN 0002-0860  
R (1)

**OBJECTIVE**

The Auto Pilot (AP) and Flight Director (FD) assist the flight crew to fly the aircraft within the normal flight envelope, in order to:

- . Optimize performance in the takeoff, go-around, climb, or descent phases
- . Follow ATC clearances (lateral or vertical)
- . Repeatedly fly and land the aircraft with very high accuracy in CAT II and CAT III conditions.

To achieve these objectives:

- . The AP takes over routine tasks. This gives the Pilot Flying (PF) the necessary time and resources to assess the overall operational situation.
- . The FD provides adequate attitude or flight path orders, and enables the PF to accurately fly the aircraft manually.

**MANAGED AND SELECTED MODES**

The choice of mode is a strategic decision that is taken by the PF.

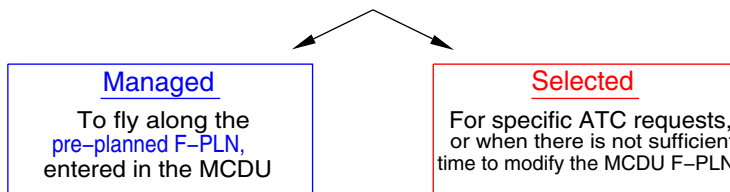

FOF 01030 00013 0001

Managed modes require:

- . Good FMS navigation accuracy (or GPS PRIMARY)
- . An appropriate ACTIVE F-PLN (i.e. the intended lateral and vertical trajectory is entered, and the sequencing of the F-PLN is monitored).

	<b>OPERATIONAL PHILOSOPHY</b>  AP / FD / ATHR	01.030
		JAN 09/07

If these two conditions are not fulfilled



Revert to **selected** modes

FOF 01030 00014 0001

## MAIN INTERFACES WITH THE AP/FD

**MCDU**  
Long-term\* interface  
  
To prepare lateral or vertical revisions, or to preset the speed for the next phase.

**FCU**  
Short-term interface  
  
To **select** the ATC HDG, expedite, speed, etc. (quickly performed "head-up")

FOF 01030 00015 0001

\*The DIR TO function is an exception to this rule.

### Operational Recommendation:

With the FMS, anticipate flight plan updates by: Preparing EN ROUTE DIVERSIONS, DIVERSION TO ALTN, CIRCLING, LATE CHANGE OF RWY in the SEC F-PLN. This enables the MCDU to be used for short-term actions.

## TASKSHARING AND COMMUNICATIONS

The FCU and MCDU must be used, in accordance with the rules outlined below, in order to ensure:

- . Safe operation (correct entries made)
- . Effective inter-pilot communication (knowing each others intentions)
- . Comfortable operations (use "available hands", as appropriate)

	<b>OPERATIONAL PHILOSOPHY</b>  AP / FD / ATHR	01.030
		JAN 09/07

**MCDU entries** are performed by the PF, during a temporary transfer of command to the PNF.

A crosscheck must be performed.

Time-consuming entries should be avoided below 10000 feet.

Entries should be restricted to those that have an operational benefit.

(PERF APPR, DIR TO, DIR TO INTERCEPT, RAD NAV, LATE CHANGE OF RUNWAY, ACTIVATE SEC F-PLN, ENABLE ALTN)

**FCU entries** are performed by:

- The PF, with the AP on.
- The PNF (upon PF request), with the AP off.

FCU entries must be announced.

Upon FCU entries:

The PF must check and announce the corresponding PFD/FMA target and mode.

The PNF must crosscheck and announce "CHECKED".

FOF 01030 00016 0001

### **AP/FD MONITORING**

The FMA indicates the status of the AP, FD, and A/THR, and their corresponding operating modes. The PF must monitor the FMA, and announce any FMA changes. The flight crew uses the FCU or MCDU to give orders to the AP/FD. The aircraft is expected to fly in accordance with these orders.

The main concern for the flight crew should be:

**WHAT IS THE AIRCRAFT EXPECTED TO FLY NOW ?**

**WHAT IS THE AIRCRAFT EXPECTED TO FLY NEXT ?**

If the aircraft does not fly as expected:

And, if in managed mode  Select the desired target

FOF 01030 00017 0001

Or, disengage the AP, and fly the aircraft manually.

### **AUTOPILOT (AP) OPERATION**

The AP can be engaged within the normal flight envelope, 5 seconds after liftoff and at least 100 ft. It automatically disengages, when the aircraft flies significantly outside the normal flight envelope limits.

	<b>OPERATIONAL PHILOSOPHY</b>	01.030
	AP / FD / ATHR	JAN 09/07

The AP cannot be engaged, when the aircraft is outside the flight envelope. Flight control laws are designed to assist the flight crew to return within the flight envelope, in accordance with the selected strategy.

The AP may be used:

- . For autoland: Down to the aircraft landing rollout, in accordance with the limitations indicated in the FCOM
- . For other approaches, the minimum height is :
  - ◇ The MDA for straight in Non Precision Approach
  - ◇ MDA-100 ft for circling approach
  - ◇ 160 ft for ILS approach with CAT1 displayed on
  - ◇ 500 ft for all others phases.

It may also be used, in case of:

- . Engine failure: Without any restriction, within the demonstrated limits, including for autoland
- . Abnormal configuration (e.g. slats/flaps failure): Down to 500 feet AGL. Extra vigilance is required in these configurations. The flight crew must be ready to take over, if the aircraft deviates from its intended, safe flight path.

The sidestick's instinctive disconnect pushbutton should be used to disengage the AP. Instinctive override action on the sidestick consists of pushing or pulling the sidestick, when the AP is engaged. This action disengages the AP, and should be done as per design, i.e. in case of an instinctive reaction (to an AP hard over for example).

#### **USE OF THE FD WITHOUT THE AP**

When manually flying the aircraft with the FDs on, the FD bars or the FPD symbol provide lateral and vertical orders, in accordance with the active modes that the flight crew selects.

Therefore:

- . Fly with a centered FD or FPD
- . If not using FD orders, turn off the FD.

It is strongly recommended to turn off both FDs, to ensure that the A/THR is in SPEED mode, if the A/THR is active.

#### **AUTOTHRUST (A/THR)**

R MSN 0002-0860

## OBJECTIVE

The A/THR computer (within the FG) interfaces directly with the engine computer, referred to as the FADEC.

The A/THR sends to the FADEC the thrust targets that are needed to:

- . Obtain and maintain a target speed, when in SPEED mode
- . Obtain a specific thrust setting (e.g. CLB, IDLE), when in THRUST mode.

## INTERFACE

When the A/THR is active, the thrust lever position determines the maximum thrust that the A/THR can command in SPEED or THRUST mode. Therefore, with A/THR active, thrust levers act as a thrust limiter or a thrust-rating panel.

The A/THR computer does not drive back the thrust levers. The PF sets them to a specific detent on the thrust lever range. The A/THR system provides cues that indicate the energy of the aircraft:

- . Speed, acceleration, or deceleration, obtained by the speed trend vector
- . N1, and N1 command on the N1 gauge.

All these cues are in the flight crews direct line of vision.

In other words, the Thrust Lever Angle (TLA) should not be used to monitor correct A/THR operation. Neither should the thrust lever position of a conventional autothrottle, be considered a cue because, in many hazardous situations, the thrust lever position can be misleading (e.g. engine failure, thrust lever jammed).

### THE TLA DETERMINES MAX THRUST FOR THE A/THR

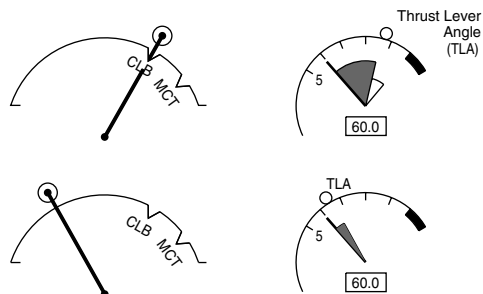

FOF 01030 00018 0001



	<b>OPERATIONAL PHILOSOPHY</b>  AP / FD / ATHR	01.030
		JAN 09/07

## NORMAL OPERATIONS

The A/THR can only be active, when the thrust levers are between IDLE and the CLB detent.

When the thrust levers are beyond the CLB detent, thrust is controlled manually to the thrust lever position, and the A/THR is armed (A/THR appears in blue on the FMA). This means that the A/THR is ready to be re-activated, when the flight crew sets the thrust levers back to the CLB detent (or below).

### A/THR OPERATING SECTORS ALL ENGINES OPERATING

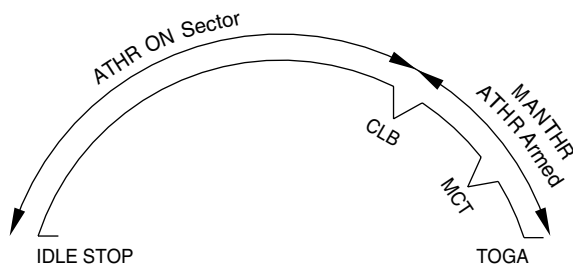

FOF 01030 00021 0001

#### **At Takeoff**

The thrust levers are set either full forward to TOGA, or to the FLX detent. Thrust is manually controlled to the TLA, and A/THR is armed. The FMA indicates this in blue.

#### **After Takeoff**

When the aircraft reaches THR RED ALT, the flight crew sets the thrust levers back to the CLB detent. This activates A/THR. MAX CLB will, therefore, be the maximum normal thrust setting that will be commanded by the A/THR in CLB, CRZ, DES, or APPR, as required.

#### **Thrust Lever(s) below the CLB Detent**

If one thrust lever is set to below the CLB detent, the FMA triggers a LVR ASYM message, as a reminder to the flight crew (e.g. this configuration might be required due to an engines high vibration level). However, if all thrust levers are set to below the CLB detent, with the A/THR active, then the ECAM repeatedly triggers the AUTO FLT AUTOTHROUST LIMITED caution. This is because there is no operational reason to be in such a situation, and to permanently limit A/THR authority on all engines. In this case, all thrust levers should either be brought back to the CLB detent, or the A/THR should be set to OFF.

#### **Thrust Levers Beyond the CLB Detent**

	<b>OPERATIONAL PHILOSOPHY</b>  AP / FD / ATHR	01.030
		JAN 09/07

If all thrust levers are set beyond the CLB detent, when A/THR is active, the flight crew manually controls thrust to the Thrust Lever Position. The FMA displays MAN THR in white, and the A/THR is armed. As a reminder, LVR CLB flashes on the FMA. This technique is most efficient, when the aircraft speed goes significantly below the target. When the aircraft speed or acceleration is satisfactory, the thrust levers should be brought back to the CLB detent. This re-activates the A/THR.

**SPEED DROP IN APPROACH: RECOMMENDED RECOVERY TECHNIQUE**

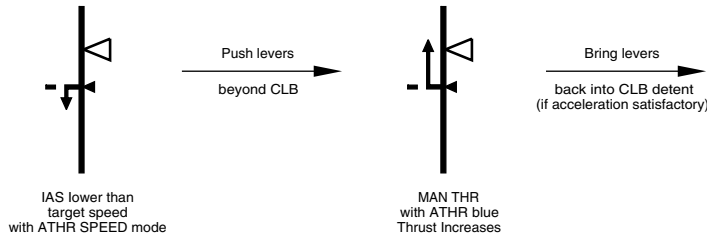

FOF 01030 00024 0001

**Note:** When using this technique during approach (e.g. to regain VAPP), the thrust levers should be moved past the CLB detent, but not beyond the MCT. In most cases, it is not necessary to go beyond MCT, and the PF may inadvertently advance thrust levers all the way to the TOGA stop, and thereby engage go-around mode.

**OPERATIONS WITH ONE ENGINE INOPERATIVE**

The above-noted principles also apply to an one-engine inoperative situation, except that A/THR can only be active, when the thrust levers are set between IDLE and MCT.

**A/THR OPERATING SECTORS - ONE ENGINE INOPERATIVE**

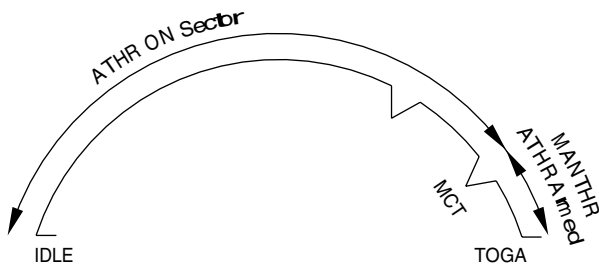

FOF 01030 00025 0001

In case of engine failure, the thrust levers will be in MCT detent for remainder of the flight. This is because MCT is the maximum thrust that can usually be commanded by the A/THR for climb or acceleration, in all flight phases (e.g. CLB, CRZ, DES or APPR).

### TO SET AUTOTHURST TO OFF

#### HOW TO SET A/THR OFF

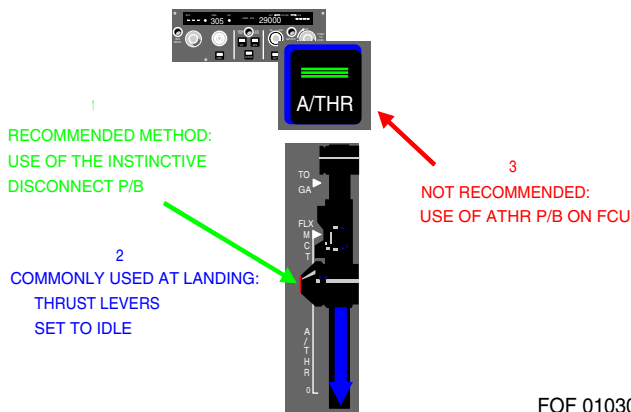

FOF 01030 00026 0001

#### 1) USE OF INSTINCTIVE DISCONNECT (I/D) PUSHBUTTON

If the I/D pushbutton is pressed when the thrust levers are in CLB detent, thrust will increase to MAX CLB. This may cause a not desired thrust change. For example, during approach, A/THR in SPEED mode, commands approximately N1 55 %. If the PF presses the I/D pushbutton, the A/THR is set to off, and thrust goes to MAX CLB. This will perturbate the approach.

	<b>OPERATIONAL PHILOSOPHY</b>  AP / FD / ATHR	01.030
		JAN 09/07

Therefore, the recommended technique for setting A/THR to off is:

- Return the thrust levers to approximately the current thrust setting, by observing the TLA symbol on the thrust gauge
- Press the I/D pushbutton

This technique minimizes thrust discontinuity, when setting A/THR to off.

RECOMMENDED TECHNIQUE TO SET A/THR OFF

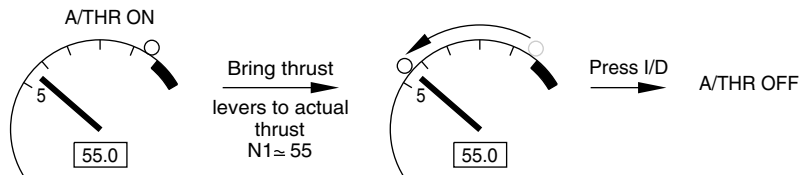

FOF 01030 00027 0001

## 2) THRUST LEVERS SET TO IDLE

If thrust levers are set to IDLE, A/THR is set to off. This technique is usually used in descent, when the A/THR is in THR IDLE, or at landing. During flare, with the A/THR active, the thrust levers are set to the CLB detent. Then, when thrust reduction is required for landing, the thrust levers should be moved smoothly and set to the IDLE stop. This will retard thrust, and set A/THR to off. As a reminder, the "RETARD" aural alert will sound. In flare, this aural alert will occur at 20 feet, except in the case of autoland, where it occurs at 10 feet.

It should be noted that, when the thrust levers are set back to IDLE and A/THR set to off: The A/THR can be reactivated by pressing the pushbutton on the FCU, and returning the thrust levers to the applicable detent. The thrust levers should be immediately returned to the applicable detent, in order to avoid an ECAM "AUTOTHRUST LIMITED" message

## 3) USE OF THE FCU PUSHBUTTON

Use of the FCU pushbutton is considered to be an involuntary A/THR off command (e.g. in the case of a failure). When pressed, thrust is frozen and remains locked at the value it had when the flight crew pressed the A/THR pushbutton, as long as the thrust levers remain in the CLB or MCT detent.

	<b>OPERATIONAL PHILOSOPHY</b>  AP / FD / ATHR	01.030
		JAN 09/07

If thrust levers are out of detent, thrust is manually controlled and, therefore, unlocked.

An ECAM caution and an FMA message trigger during thrust lock:

⇒ THR LK appears in amber on the FMA

⇒ The ECAM caution is:

**AUTOFLT: ATHR OFF**

ENG.....THR LOCKED

thrust levers.....move

In this case, when the flight crew moves the thrust levers out of detent, full manual control is recovered, and the THR LK message disappears from the FMA.

This feature should not be used, unless the instinctive disconnect pushbuttons are inoperative.

**ALPHA FLOOR**

When the aircraft's angle-of-attack goes beyond the ALPHA FLOOR threshold, this means that the aircraft has decelerated significantly (below ALPHA PROT speed): A/THR activates automatically and orders TOGA thrust, regardless of the thrust lever position.

The example below illustrates that:

- . The aircraft is in descent with the thrust levers manually set to IDLE.
- . The aircraft decelerates, during manual flight with the FD off, as indicated on the FMA.

**SPEED SCALE AND FMA INDICATIONS IN A TYPICAL A FLOOR CASE**

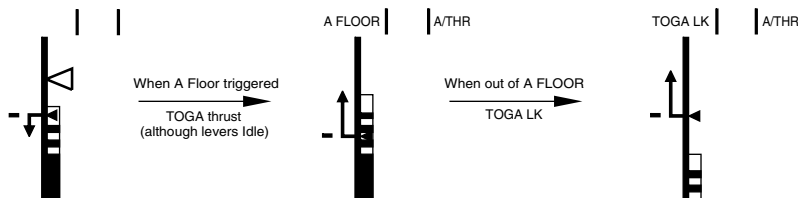

FOF 01030 00030 0001

	<b>OPERATIONAL PHILOSOPHY</b>  AP / FD / ATHR	01.030
		JAN 09/07

When the speed decreases, so that the angle-of-attack reaches the ALPHA FLOOR threshold, A/THR activates and orders TOGA thrust, despite the fact that the thrust levers are at IDLE.

When the aircraft accelerates again, the angle-of-attack drops below the ALPHA FLOOR threshold. TOGA thrust is maintained or locked. This enables the flight crew to reduce thrust, as necessary. TOGA LK appears on the FMA to indicate that TOGA thrust is locked. The desired thrust can only be recovered by setting A/THR to off, with the instinctive disconnect pushbutton.

ALPHA floor is available, when the flight controls are in NORMAL LAW, from lift off to 100 ft R/A at landing. It is inhibited in some cases of engine failure.

**A/THR USE - SUMMARY**

Use of A/THR is recommended during the entire flight. It may be used in most failures cases, including:

- . Engine failure, even during autoland
- . Abnormal configurations

However, use of manual thrust is recommended when the autotrim function is lost. The aim of this recommendation is to avoid large thrust changes.

**A/THR USE IN FLIGHT**

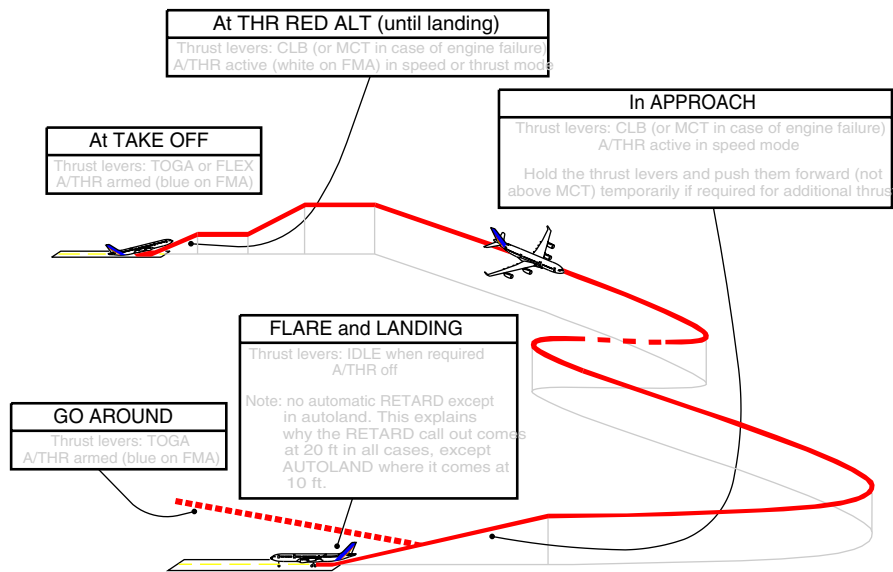

FOF 01030 00029 0001

A/THR should be monitored via the:

- . FMA SPEED / SPEED TREND on the PFD
- . N1/N1 command (EPR) on the ECAM E/WD.

## AP, FD, A/THR MODE CHANGES AND REVERSIONS

R MSN 0002-0860

### INTRODUCTION

The flight crew manually engages the modes. However, they may change automatically, depending on the:

- . AP, FD, and A/THR system integration
- . Logical sequence of modes
- . So-called "mode reversions".

### AP, FD, ATHR SYSTEM INTEGRATION

There is a direct relationship between aircraft pitch control, and engine thrust control. This relationship is designed to manage the aircraft's energy.

- . If the AP/FD pitch mode controls a vertical trajectory (e.g. ALT, V/S, FPA, G/S):  
A/THR controls speed
- . If the AP/FD pitch mode controls a speed (e.g. OP CLB, OP DES):  
A/THR controls thrust (THR CLB, THR IDLE)
- . If no AP/FD pitch mode is engaged (i.e. AP is off and FD is off):  
A/THR controls speed

Therefore, any change in the AP/FD pitch mode is associated with a change in the A/THR mode.

*Note: For this reason, the FMA displays the A/THR mode and the AP/FD vertical mode columns next to each other.*

### THE LOGICAL SEQUENCE OF MODES

In climb, when the flight crew selects a climb mode, they usually define an altitude target, and expect the aircraft to capture and track this altitude. Therefore, when the flight crew selects a climb mode, the next logical mode is automatically armed.

For example:

#### AP/FD MODE CAPTURE AND TRACKING (1)

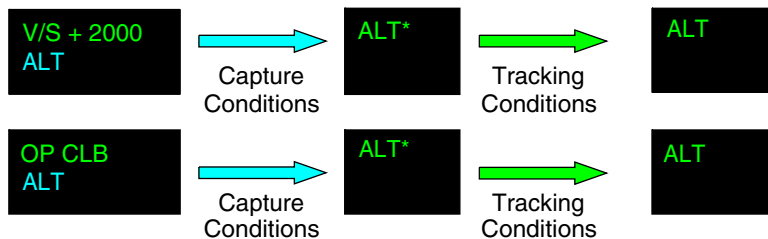

FOF 01030 03717 0001

The flight crew may also manually arm a mode in advance, so that the AP/FD intercepts a defined trajectory.

Typically, the flight crew may arm NAV, LOC-G/S, and APPNAV-FINAL. When the capture or tracking conditions occur, the mode will change sequentially.



AP/FD MODE CAPTURE AND TRACKING (2)

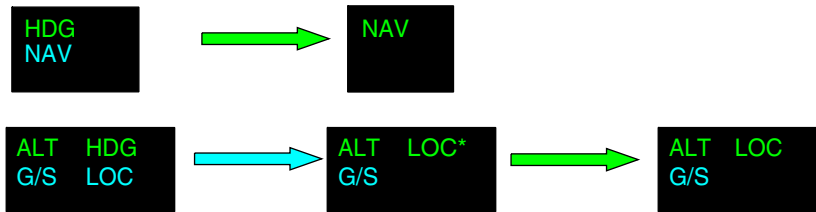

FOF 01030 03719 0001

These logical mode changes occur, when the modes are armed. They appear in blue on the FMA.

**MODE REVERSIONS**

**GENERAL**

Mode reversions are automatic mode changes that unexpectedly occur, but are designed to ensure coherent AP, FD, and A/THR operations, in conjunction with flight crew input (or when entering a F-PLN discontinuity).

For example, a reversion will occur, when the flight crew:

- . Changes the FCU ALT target in specific conditions
- . Engages a mode on one axis, that will automatically disengage the associated mode on the other axis
- . Manually flies the aircraft with the FD on, but does not follow the FD orders, which leads to the aircraft to the limits of the flight envelope.

Due to the unexpected nature of their occurrence, the FMA should be closely-monitored for mode reversions.

**FLIGHT CREW CHANGE OF FCU ALT TARGET ► ACTIVE VERTICAL MODE NOT POSSIBLE**

FCU CHANGE RESULTING REVERSION TO VS MODE

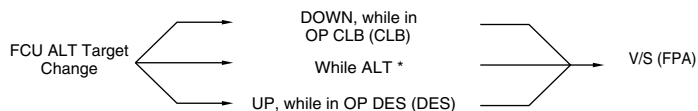

FOF 01030 03721 0001

This reversion to the V/S (FPA) mode on the current V/S target does not modify the pitch behaviour of the aircraft.

It is the flight crews responsibility to change it as required.

**FLIGHT CREW HDG OR TRK MODE ENGAGEMENT ► DISENGAGEMENT OF ASSOCIATED MODE ON THE VERTICAL AXIS**

This reversion is due to the integration of the AP, FD, and A/THR with the FMS.

When the flight crew defines a F-PLN, the FMS considers this F-PLN as a whole (lateral + vertical). Therefore, the AP will guide the aircraft along the entire F-PLN:

- . Along the LAT F-PLN (NAV APP NAV modes)
- . Along the VERT F-PLN (CLB DES FINAL modes).

Vertical managed modes can only be used, if the lateral managed NAV mode is used. If the flight crew decides to divert from the lateral F-PLN, the autopilot will no longer guide the aircraft along the vertical F-PLN.

Therefore, in climb:

LATERAL MODE CHANGE AND VERTICAL MODE REVERSION

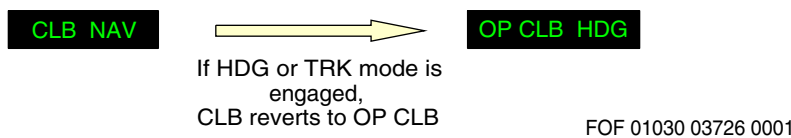

In descent:

LATERAL MODE CHANGE AND VERTICAL MODE REVERSION

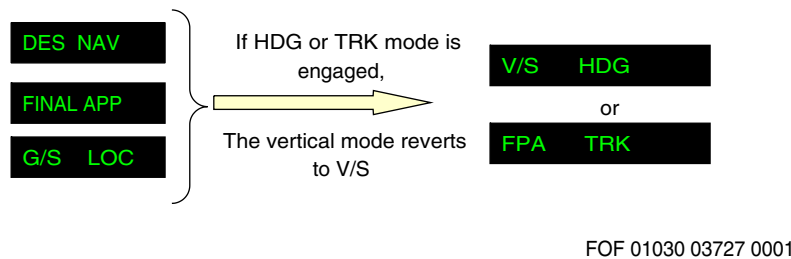

This reversion to V/S (FPA) mode on the current V/S target does not modify the pitch behavior of the aircraft. It is the flight crews responsibility to adapt pitch, if necessary.

**THE AIRCRAFT ENTERS A F-PLN DISCONTINUITY**

NAV mode is lost, when entering a F-PLN discontinuity. On the lateral axis, the aircraft reverts to HDG (or TRK) mode. On the vertical axis, the same reversion (as the one indicated above) occurs.

**THE PF MANUALLY FLIES THE AIRCRAFT WITH THE FD ON, AND DOES NOT FOLLOW THE FD PITCH ORDERS**

If the flight crew does not follow the FD pitch orders, an A/THR mode reversion occurs. This reversion is effective, when the A/THR is in THRUST MODE (THR IDLE, THR CLB), and the aircraft reaches the limits of the speed envelope (VLS, VMAX):

REVERSION TO SPEED MODE

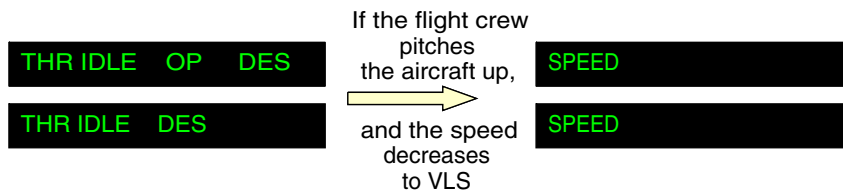

A/THR REVERTS TO SPEED MODE

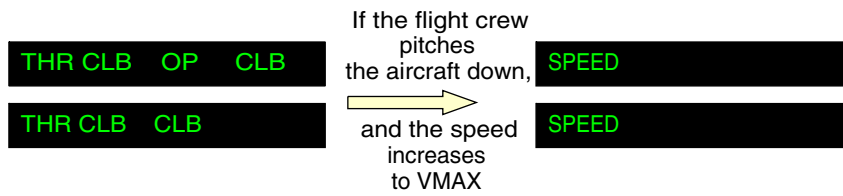

A/THR REVERTS TO SPEED MODE

FOF 01030 03728 0001

A/THR in SPEED mode automatically readjusts thrust to regain the target speed. The FD bars will disappear, because they are not being followed by the PF.

**TRIPLE CLICK**

R MSN 0002-0860

	<b>OPERATIONAL PHILOSOPHY</b>  AP / FD / ATHR	01.030
		JAN 09/07

The "triple click" is an aural alert. It is an attention-getter, designed to draw the flight crew's attention to the FMA.

The PFD FMA highlights a mode change or reversion with a white box around the new mode, and the pulsing of its associated FD bar.

The reversions, described in the previous paragraph, are also emphasized via the triple click aural alert.

Note: *The triple click also appears in the following, less usual, cases:*

- . *SRS ► CLB (OPCLB) reversion: If, the flight crew selects a speed on the FCU*
- . *The V/S selection is "refused" during ALT \*: The flight crew pulls the V/S knob, while in ALT\**
- . *The V/S target is not followed, because the selected target is too high, and leads to VLS/VMAX.*

	<b>OPERATIONAL PHILOSOPHY</b>	01.030
	AP / FD / ATHR	JAN 09/07

**HIGHLIGHTS**

- (1) Correction of printing error

	<b>OPERATIONAL PHILOSOPHY</b>  ECAM	01.040
		JAN 09/07

### PURPOSE OF THE ECAM

R MSN 0002-0860

The Electronic Centralized Aircraft Monitoring (ECAM) system is a main component of Airbus two-crewmember cockpit, which also takes the "dark cockpit" and "forward-facing crew" philosophies into account.

The purpose of the ECAM is to:

- . Display aircraft system information
- . Monitor aircraft systems
- . Indicate required flight crew actions, in most normal, abnormal and emergency situations.

As the ECAM is available in most failure situations, it is a significant step in the direction towards a paperless cockpit and the removal of memory items.

R MSN 0002-0860

### MAIN PRINCIPLES

#### **INFORMATION PROVIDED WHEN NEEDED**

One of the main advantages of the ECAM is that it displays applicable information to the flight crew, on an "as needed" basis. The following outlines the ECAMs operating modes:

- . **Normal Mode:**  
Automatically displays systems and memos, in accordance with the flight phase.
- . **Failure Mode:**  
Automatically displays the appropriate emergency/abnormal procedures, in addition to their associated system synoptic.
- . **Advisory Mode:**  
Automatically displays the appropriate system synoptic, associated with a drifting parameter.
- . **Manual Mode:**

	<b>OPERATIONAL PHILOSOPHY</b>  ECAM	01.040
		JAN 09/07

Enables the flight crew to manually select any system synoptic via the ECAM Control Panel (ECP).

Most warnings and cautions are inhibited during critical phases of flight (T/O INHIBIT LDG INHIBIT), because most system failures will not affect the aircraft's ability to continue a takeoff or landing.

### **FAILURE LEVELS**

The ECAM has three levels of warnings and cautions. Each level is based on the associated operational consequence(s) of the failure. Failures will appear in a specific color, according to defined color-coding system, that advises the flight crew of the urgency of a situation in an instinctive, unambiguous manner. In addition, Level 2 and 3 failures are accompanied by a specific aural warning: A Continuous Repetitive Chime (CRC) indicates a Level 3 failure, and a Single Chime (SC) indicates a Level 2 failure.

Failure Level	Priority	Color Coding	Aural Warning	Recommended Crew Action
Level 3	Safety	Red	CRC	Immediate
Level 2	Abnormal	Amber	SC	Awareness, then action
Level 1	Degradation	Amber	None	Awareness, then Monitoring

When there are several failures, the FWC displays them on the Engine Warning Display (E/WD) in an order of priority, determined by the severity of the operational consequences. This ensures that the flight crew sees the most important failures first.

### **FEEDBACK**

The ECAM provides the flight crew with feedback, after action is taken on affected controls:

- . **The System Synoptic:**  
Displays the status change of affected components.
- . **The Memo:**  
Displays the status of a number of systems selected by the flight crew (e.g. anti ice).
- . **The Procedures:**  
When the flight crew performs a required action on the cockpit panel, the ECAM usually clears the applicable line of the checklist (except for some systems or actions, for which feedback is not available).

	<b>OPERATIONAL PHILOSOPHY</b>  ECAM	01.040
		JAN 09/07

The ECAM reacts to both failures and pilot action.

**ECAM HANDLING**

R MSN 0002-0860

Task sharing is essential to effective ECAM operation, particularly in the case of abnormal operations.

**NORMAL OPERATIONS**

On ground, the ECAM MEMO is reviewed for feedback on temporarily-selected items (e.g. SEAT BELTS/IGNITION/ENG A/I), and to check whether IRs are aligned. If alignment is not complete, the time remaining will be displayed. It is, therefore, not necessary to refer to the OVHD panel.

In cruise, the main systems should periodically be reviewed during flight (ENG, BLEED, ELEC AC/DC, HYD, FUEL, F/CTL), to ensure that they are operating normally, and to detect any potential problem in advance.

The ECAM MEMO must be included in the instrument review. In cruise, in most of the cases, it should be blank. It helps to make the flight crew aware of any system that a flight crewmember temporarily selected, but forgot to deselect.

A STS label, displayed at the bottom of the E/WD, indicates that there is a STATUS to be reviewed. Therefore, when a C/L calls for STATUS review, press STS, only if the label appears.

If there is a STS at engine shutdown, it will pulse at the bottom of the E/WD. If this is the case, the STATUS page should be reviewed for help in completing the technical log.

**IN CASE OF ADVISORY**

The flight crewmember that first notices an advisory announces: "ADVISORY on XYZ system". Then, the PF requests the PNF to review the drifting parameter. If time permits, the PNF may refer to the QRH Part 2, containing recommended actions in various advisory situations.

R (1) (2)

**ABNORMAL OPERATIONS**



	<b>OPERATIONAL PHILOSOPHY</b>  ECAM	01.040
		JAN 09/07

## TASK SHARING RULES

When the ECAM displays a warning or a caution, the first priority is to ensure that a safe flight path is maintained. The successful outcome of any ECAM procedure depends on:

- . Correct reading and application of the procedure,
- . effective task sharing,
- . and conscious monitoring and crosschecking.

It is important to remember that, after ECAM ACTIONS announcement by the PF:

- . The PF's task is to fly the aircraft, navigate, and communicate.
- . The PNF's task is to manage the failure, on PF command.

The PF usually remains the PF for the entire flight, unless the Captain decides to take control.

The PF will then control the aircraft's flight path, speed, configuration, and engines. The PF will also manage navigation and communication, and initiate the ECAM actions to be performed by the PNF, and check that the actions are completed correctly.

The PNF has a considerable workload: Managing ECAM actions and assisting the PF on request. The PNF reads the ECAM and checklist, performs ECAM actions on PF command, requests PF confirmation to clear actions, and performs actions required by the PF. The PNF never touches the thrust levers, even if requested by the ECAM.

Some selectors or pushbuttons (including the ENG MASTER switch, FIRE pushbutton, IR, IDG and, in general, all guarded switches) must be completely crosschecked by both the PF and PNF, before they are moved or selected, to prevent the flight crew from inadvertently performing irreversible actions.

To avoid mistakes in identifying the switches, Airbus overhead panels are designed to be uncluttered. When the ECAM requires action on overhead panel pushbuttons or switches, the correct system panel can be identified by referring to the white name of the system on the side of each panel. Before performing any action, the PNF should keep this sequence in mind: "System, then procedure/selector, then action" (e.g. "air, crossbleed, close"). This approach, and announcing an intended selection before action, enables the PNF to keep the PF aware of the progress of the procedure.

It is important to remember that, if a system fails, the associated FAULT light on the system pushbutton (located on the overhead panel) will come on in amber, and enable correct identification.

When selecting a system switch or pushbutton, the PNF should check the SD to verify that the selected action has occurred (e.g. closing the crossbleed valve should change the indications that appear on the SD).

GENERAL OVERVIEW OF ASSIGNED ACTIONS

PF	PNF
<div style="border: 1px solid black; padding: 5px; width: fit-content; margin: 0 auto;">           First pilot who notices:            MASTER CAUTION/MASTER WARNING ..... RESET            ANNOUCE ..... "TITLE OF FAILURE"         </div>	
FLY THE AIRCRAFT  ORDER ..... ECAM ACTION (2)	ECAM ..... CONFIRM (1)
(3)  ECAM ACTION COMPLETE .... CHECK CONFIRM ..... CLEAR	ECAM ACTIONS ..... PERFORM REQUEST ..... CLEAR "name of SYS"?  ECAM ..... CLEAR
(4)  CONFIRM ..... CLEAR	SYSTEM PAGE ..... ANALYSE REQUEST ..... CLEAR "name of SYS"? SYSTEM DISPLAY ..... CLEAR
CONFIRM ..... STATUS (5)  CONFIRM ..... CLEAR STATUS	ANNOUNCE ..... STATUS? STATUS ..... READ REQUEST ..... CLEAR STATUS? STATUS ..... CLEAR (6) ANNOUNCE ..... ECAM ACTIONS COMPLETED
<div style="border: 1px solid black; padding: 5px; width: fit-content; margin: 0 auto;">             SITUATION ASSESMENT/DECISION           </div>	

FOF 01040 00028 0001

1. The PNF should review the overhead panel and/or associated SD to analyze and confirm the failure, prior to taking any action, and should bear in mind that the sensors used for the SD are different from the sensors that trigger failure.
2. In case of a failure during takeoff or go-around, ECAM actions should be delayed until the aircraft reaches approximately 400 feet, and is stabilized on a safe trajectory. This is an appropriate compromise between stabilizing the aircraft and delaying action.

	<b>OPERATIONAL PHILOSOPHY</b>	01.040
	ECAM	JAN 09/07

3. When the ECAM displays several failures, the sequence (action, then request and confirmation, before clearance) should be repeated for each failure.  
When all necessary actions are completed, amber messages and red titles will no longer appear on the E/WD.
4. When the ECAM displays several system pages, the sequence (request and confirmation before clearance) should be repeated for each system page.
5. The PF may call out "STOP ECAM" at any time, if other specific actions must be performed (normal C/L, application of an OEB, or performing a computer reset). When the action is completed, the PF must call out: "CONTINUE ECAM".
6. When the flight crew selects CONF 1 for approach, or sets QNH (QFE) during descent (when APPR C/L should be requested), the SD automatically displays the STATUS. The STS should be carefully reviewed, and the required procedure applied.
7. When ECAM actions have been completed, and the ECAM status has been reviewed, the PNF may refer to the FCOM procedure for supplementary information, if time permits. However, in critical situations the flight should not be prolonged only to consult the FCOM.

#### **IF THE ECAM WARNING (OR CAUTION) DISAPPEARS WHILE APPLYING THE PROCEDURE**

If an ECAM warning disappears, while a procedure is being applied, the warning can be considered no longer applicable. Application of the procedure can be stopped.

For example, during the application of an engine fire procedure, if the fire is successfully extinguished with the first fire extinguisher bottle, the ENG FIRE warning disappears, and the procedure no longer applies. Any remaining ECAM procedures should be performed as usual.

#### **SOME ADDITIONAL REMARKS**

- . There are very few memory items:
  - Emergency descent initiation
  - First reaction, in case of an unreliable speed indication
  - Loss of braking
  - Windshear (reactive and predictive)
  - EGPWS and GPWS
  - TCAS
- . In some cases, the ECAM displays: "LAND ASAP" (As Soon As Possible):
  - RED LAND ASAP:  
Land as soon as possible at the nearest suitable airport at which a safe approach and landing can be made.

	<b>OPERATIONAL PHILOSOPHY</b>  ECAM	01.040
		JAN 09/07

- AMBER LAND ASAP:  
Advice the flight crew to consider landing at the nearest suitable airport.

- . OEB Reminder  
Some Operational Engineering Bulletins (OEBs) contain information that may impact flight crew action, in the event of a system failure. OEBs are filed in the QRH.  
If the OEB reminder function is activated for an ECAM warning/caution, the ECAM will display the : "Refer to QRH Proc" line, when necessary. This line may appear instead of the procedure, or it may be added to the ECAM STATUS.  
In such failure cases, the flight crew should refer to the applicable procedure in the QRH.
- . Some procedures require reference to the QRH

## **IN CASE OF AN ECAM SYSTEM FAULT**

### **DISPLAY UNIT FAILURE**

If one ECAM screen fails, the remaining one will display the E/WD. However, in such a case, if a failure or advisory occurs, the system or status page are not displayed automatically. The PNF can display a system synoptic on the remaining display unit, by pressing the assigned system pushbutton on the ECP. The synoptic will appear, as long as the pushbutton is pressed.

Therefore, in the case of an advisory and/or failure (indicated by an ADV flag that pulses in white on the bottom of the E/WD), the PNF must call up the affected system synoptic, by pressing the related pushbutton.

To review two or three pages of status messages: The PNF should release the STS pushbutton for less than two seconds, then press and hold it again.

A double ECAM screen configuration can be recovered using the ECAM/ND switching selector:

- . If the Captain is the PNF, the switch should be set to "CPT".
- . If the First Officer is the PNF, the switch should be set to "F/O".

The applicable ND screen will then display the second ECAM image.

### **DMC FAILURES**

In case all of the ECAM DMC channels fail, each flight crewmember may display the engine standby page on their respective ND (generated by the DMCs EFIS channel).

	OPERATIONAL PHILOSOPHY	01.040
	ECAM	JAN 09/07

## ECP FAILURE

In the case of an ECP failure, the CLR, RCL, STS, ALL and EMER CANCEL keys will continue to operate, because they are hardwired to the FWC/DMC. Therefore, the "ALL" key can be used to scroll all SD pages and display the desired one (by releasing the key, when the desired SD page appears).

## FLUCTUATING CAUTION

Any fluctuating caution can be deleted with the EMER CANCEL pushbutton. When pressed, the EMER CANCEL pushbutton deletes both the aural alert, and the caution for the remainder of the flight. This is indicated on the STATUS page, by the "CANCELLED CAUTION" title. Any caution messages that have been inhibited via the EMER CANCEL pushbutton can be recalled by pressing and holding the RCL key for more than three seconds.

The EMER CANCEL pushbutton inhibits any aural warning that is associated with a red warning, but does not affect the warning itself.

R MSN 0002-0860

## USE OF SUMMARIES

### GENERAL

Summaries consist of QRH procedures, and are designed to assist the flight crew to manage applicable actions, in the event of an EMER ELEC CONFIG or a dual hydraulic failure.

In any case, **ECAM actions should be applied first** (actions and STATUS review). The PNF should refer to the applicable QRH summary, only after announcing: "ECAM ACTIONS COMPLETED".

When a failure occurs, and after performing the ECAM actions, the PNF should refer to the "CRUISE" section of the summary, to determine the landing distance coefficient. Due to the fact that normal landing distances also appear on this page, the PNF can compute the landing distance with the failure, **and decide whether or not to divert.**

### APPROACH PREPARATION

	<b>OPERATIONAL PHILOSOPHY</b>  ECAM	01.040
		JAN 09/07

As usual, approach preparation includes a review of the ECAM STATUS.

After reviewing the STATUS, the PNF should refer to the "CRUISE" section of the summary, to determine the VREF correction, and compute the VAPP.

This assumes that the PNF is aware of the computation method, and uses the VREF displayed on the MCDU (with the updated destination). The summary provides a VREF table, in the event that failure results in the loss of the MCDU.

The LANDING and GO-AROUND sections of the summary should be used for the **approach briefing**.

### **APPROACH**

To perform the APPR PROC, the APPROACH section of the summary should be read (mainly because of the flap extension procedure, that does not entirely appear on the ECAM).

This assumes that the recommendations, provided in this part of the summary are sufficient for understanding, and that it will not be necessary for the flight crew to consult the "LANDING WITH FLAPS (SLATS) JAMMED" paper procedure.

**The PNF should then review the ECAM STATUS**, and check that all the APPR PROC actions have been completed.

### SEQUENCE

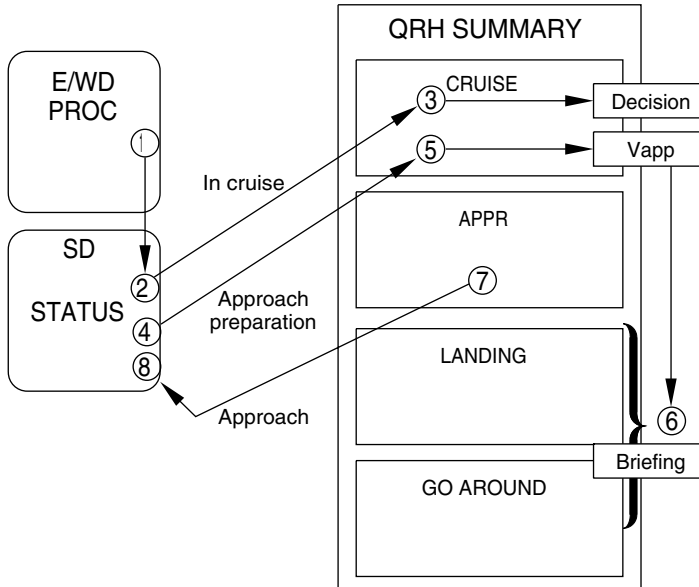

FOF 01040 03720 0001

	<b>OPERATIONAL PHILOSOPHY</b>	01.040
	ECAM	JAN 09/07

**HIGHLIGHTS**

- (1) Clarification of LAND ASAP definition.
- (2) Removal of call outs that are not in line with Airbus training policy.



<b>02.010</b>	<b>GENERAL</b>	
	- INTRODUCTION	1
	- USE OF THE NORMAL CHECKLIST	1
	- COMMUNICATION	2
<b>02.020</b>	<b>PRE START</b>	
	- MEL	1
	- SECURED AND TRANSIT STOP	4
	- SAFETY EXTERIOR INSPECTION	4
	- PRELIMINARY COCKPIT PREPARATION	4
	- EXTERIOR INSPECTION	5
	- ADIRS INITIALIZATION	6
	- COCKPIT PREPARATION	9
	- MISCELLANEOUS	16
<b>02.030</b>	<b>START</b>	
	- INTRODUCTION	1
	- AUTOMATIC STARTING SEQUENCE	1
	- AFTER ENGINE START	3
	- AVERAGE IDLE ENGINE PARAMETERS	4
	- ENGINE START MALFUNCTION	5
	- MANUAL ENGINE START	6
	- TAILPIPE FIRE	6
	- ENGINE WARM-UP PERIOD	7
	- AFTER START FLOW PATTERN	7
<b>02.040</b>	<b>TAXI</b>	
	- TAXI ROLL AND STEERING	1
	- FIGURES	4
	- TAXI CAMERA	7
	- BRAKE CHECK	8
	- CARBON BRAKE WEAR	9
	- TAXI SPEED AND BRAKING	9

- BRAKE TEMPERATURE	9
- BRAKING ANOMALIES	10
- BRAKE FANS	10
- FLIGHT CONTROL CHECK	11
- TAKEOFF BRIEFING CONFIRMATION	12
- TAXI WITH ONE ENGINE SHUTDOWN	13
- TAXI WITH TWO ENGINES SHUTDOWN	14
- MISCELLANEOUS	15
- BEFORE TAKEOFF FLOW PATTERN	16
<b>02.050 TAKEOFF</b>	
- THRUST SETTING	1
- TAKE-OFF ROLL	3
- TYPICAL AIRCRAFT ATTITUDE AT TAKEOFF AFTER LIFT-OFF	4
- ROTATION	5
- LONG AIRCRAFT SPECIFICITY	6
- AIRCRAFT GEOMETRY	7
- TAIL STRIKE AVOIDANCE	10
- MAXIMUM DEMONSTRATED CROSSWIND FOR TAKE-OFF	14
- MAXIMUM CERTIFIED CROSSWIND FOR TAKEOFF	15
- AP ENGAGEMENT	16
- VERTICAL PROFILE	17
- LATERAL PROFILE	18
- THRUST REDUCTION ALTITUDE	19
- ACCELERATION ALTITUDE	19
- TAKE-OFF AT HEAVY WEIGHT	20
- IMMEDIATE TURN AFTER TAKE-OFF	21
- LOW ALTITUDE LEVEL-OFF	21
- NOISE ABATEMENT TAKE-OFF	21
<b>02.060 CLIMB</b>	
- CLIMB THRUST	1
- AP/FD CLIMB MODES	1

	<b>NORMAL OPERATIONS</b>	02.000
	TABLE OF CONTENTS	JAN 09/07

	- SMALL ALTITUDE CHANGES	2
	- SPEED CONSIDERATIONS	2
	- VERTICAL PERFORMANCE PREDICTIONS	4
	- LATERAL NAVIGATION	4
	- 10.000 FT FLOW PATTERN	5
<b>02.070</b>	<b>CRUISE</b>	
	- PREFACE	1
	- FMS USE	1
	- COST INDEX	4
	- SPEED CONSIDERATIONS	5
	- ALTITUDE CONSIDERATIONS	6
	- STEP CLIMB	6
	- EFFECT OF ALTITUDE ON FUEL CONSUMPTION	9
	- FUEL MONITORING	11
	- FUEL TEMPERATURE	12
	- APPROACH PREPARATION	12
	- APPROACH BRIEFING	15
<b>02.080</b>	<b>DESCENT</b>	
	- PREFACE	1
	- COMPUTATION PRINCIPLES	1
	- GUIDANCE AND MONITORING	2
	- MODE REVERSION	7
	- DESCENT CONSTRAINTS	7
	- 10.000 FT FLOW PATTERN	8
<b>02.090</b>	<b>HOLDING</b>	
	- PREFACE	1
	- HOLDING SPEED AND CONFIGURATION	1
	- IN THE HOLDING PATTERN	1
<b>02.100</b>	<b>APPROACH GENERAL</b>	
	- PREFACE	1

	- INITIAL APPROACH	1
	- INTERMEDIATE APPROACH	3
	- FINAL APPROACH	5
<b>02.110</b>	<b>ILS APPROACH</b>	
	- PREFACE	1
	- INITIAL APPROACH	1
	- INTERMEDIATE APPROACH	2
	- FINAL APPROACH	3
	- ILS RAW DATA	4
<b>02.120</b>	<b>NON PRECISION APPROACH</b>	
	- PREFACE	1
	- APPROACH STRATEGY	1
	- LIMITATIONS	1
	- INITIAL APPROACH	2
	- INTERMEDIATE APPROACH	3
	- FINAL APPROACH	5
	- REACHING THE MINIMA	6
	- LOC ONLY APPROACH	7
	- LOC BACK COURSE APPROACH	7
<b>02.130</b>	<b>CIRCLING APPROACH</b>	
	- PREFACE	1
	- APPROACH PREPARATION	1
	- FINAL INSTRUMENT APPROACH	2
	- CIRCLING APPROACH	2
<b>02.140</b>	<b>VISUAL APPROACH</b>	
	- INITIAL APPROACH	1
	- INTERMEDIATE/FINAL APPROACH	1
<b>02.150</b>	<b>PRECISION APPROACH</b>	
	- GENERAL	1

	- DEFINITION	1
	- FLIGHT PREPARATION	3
	- APPROACH PREPARATION	3
	- APPROACH PROCEDURE	5
	- FAILURE AND ASSOCIATED ACTIONS	8
	- AUTOLAND IN CAT 1 OR BETTER WEATHER CONDITIONS	8
<b>02.160</b>	<b>LANDING</b>	
	- PREFACE	1
	- MAIN GEAR CLEARANCE	1
	- FLARE	3
	- MAXIMUM DEMONSTRATED CROSSWIND FOR LANDING	4
	- CALL OUT	6
	- DEROTATION	6
	- ROLL OUT	7
	- BRAKING	8
	- FACTORS AFFECTING LANDING DISTANCE	12
	- CLEARANCE AT TOUCH DOWN	13
	- TAIL STRIKE AVOIDANCE	16
<b>02.170</b>	<b>GO AROUND</b>	
	- PREFACE	1
	- CONSIDERATIONS ABOUT GO-AROUND	1
	- AP/FD GO-AROUND PHASE ACTIVATION	1
	- GO-AROUND PHASE	2
	- LEAVING THE GO-AROUND PHASE	3
	- REJECTED LANDING	4
<b>02.180</b>	<b>TAXI IN</b>	
	- BRAKE TEMPERATURE	1
	- ENGINES COOLING PERIOD	1
	- TAXI WITH ONE ENGINE SHUTDOWN	2
	- TAXI WITH TWO ENGINES SHUTDOWN	2

	NORMAL OPERATIONS	02.000
	TABLE OF CONTENTS	JAN 09/07

- AFTER LANDING FLOW PATTERN

3

	<b>NORMAL OPERATIONS</b>	02.010
	GENERAL	JAN 09/07

## INTRODUCTION

R MSN 0002-0860

The NORMAL OPERATIONS Chapter outlines the techniques that should be applied for each flight phase, in order to optimize the use of Airbus aircraft. This chapter must be read in parallel with the FCOM, which provides normal procedures, and their associated tasksharing, callouts, and checklists.

All of these flying techniques are applicable to normal conditions.

Other techniques applicable to adverse weather conditions, are addressed in the ADVERSE WEATHER section of Chapter 4.

There are flow patterns at the end of some flight phases to indicate where the actions are to be performed. All flight crewmembers must apply the flow patterns, to ensure that the flight crew performs the actions necessary for a specific flight phase, before completing an applicable checklist.

## USE OF THE NORMAL CHECKLIST

R MSN 0002-0860

Airbus NORMAL CHECKLIST takes into account ECAM information, and includes only those items that can directly impact flight safety and efficiency, if actions are not correctly performed. These checklists are of a "non-action" type (i.e. all actions should be completed from memory before the flight crew performs the checklist).

The NORMAL CHECKLIST includes eight flight phases. The BEFORE START, BEFORE TAKEOFF, and AFTER TAKEOFF checklists are divided in two sections: The "Down to the Line" section, and the "Below the Line" section. This format is designed to help flight crews to manage the workload.

For example, the "BEFORE START - Down to the Line" checklist may be called out, as soon as the Load and Trim Sheet is available and takeoff data is set. On the other hand, the "BEFORE START - Below the Line" checklist may be called out after obtaining start-up clearance.

The Pilot Flying (PF) requests the NORMAL CHECKLIST, and the Pilot Non Flying (PNF) reads it. The checklist actions are referred to as "challenge/response"-type actions. The PF "responds" to the "challenge" only after checking the configuration.

	<b>NORMAL OPERATIONS</b>  GENERAL	02.010
		JAN 09/07

If the configuration does not correspond to the checklist response, the PF must take corrective action before "responding" to the "challenge". If corrective action is not possible, then the PF must modify the response to reflect the real situation (with a specific answer). When necessary, the other flight crewmember must crosscheck the validity of the response. The challenger (PNF) waits for a response before proceeding with the checklist. For the checklist items that are identified as "AS RQRD", the response should correspond to the real condition or configuration of the system.

The PNF must announce "LANDING CHECKLIST COMPLETED", after reading and completing the checklist.

**COMMUNICATION**

R MSN 0002-0860

R (1)

R (2)

**EMERGENCY CALL**

Some abnormal/emergency procedures require flight and cabin crews to use specific phraseology when communicating with each other. To ensure effective communication between the flight and cabin crews, the standard phraseology may be recalled at the preflight phase.

FROM	TO	PHRASEOLOGY	REMARKS
cockpit	cabin	Passenger Address (PA) System: "PURSER TO COCKPIT, PLEASE!"	The Purser, or any other cabin crewmember, must go to the cockpit
cockpit	cabin	Passenger Address (PA) System: "ATTENTION CREW! AT STATIONS!"	An emergency evacuation may soon be required
cockpit	cabin	Passenger Address (PA) System: "CABIN CREW and PASSENGERS REMAIN SEATED!"	The Captain decides that an evacuation is not required



	<b>NORMAL OPERATIONS</b>	02.010
	GENERAL	JAN 09/07

cockpit	cabin	Passenger Address (PA) System: "PASSENGERS EVACUATE!"	The Captain orders an immediate evacuation
cabin	cockpit	Interphone: "PRIO CAPT"	Any cabin crewmember can make such a call. The flight crew must reply

### **CROSS-COCKPIT COMMUNICATION**

The term "cross-cockpit communication" refers to communication between the PF and the PNF. This communication is vital for any flight crew. Each time one flight crewmember adjusts or changes information and/or equipment on the flight deck, the other flight crewmember must be notified, and an acknowledgement must be obtained.

Such adjustments and changes include:

- . FMGS alterations
- . Changes in speed or Mach
- . Tuning navigation aids
- . Flight path modifications
- . System selections (e.g. anti-ice system)

When using cross-cockpit communication, standard phraseology is essential to ensure effective flight crew communication. This phraseology should be concise and exact, and is defined in the FCOM 3.03.90.

The flight crew must use the headset:

- . From the ENGINE START phase until the TOP OF CLIMB phase
- . From The TOP OF DESCENT phase until the aircraft is parked.

### **"STERILE" COCKPIT RULE**

When the aircraft is below 10 000 feet, any conversation that is not essential should be avoided: This includes conversations that take place in the cockpit, or between the flight and cabin crewmembers. It is important to adhere to this policy, in order to facilitate communication between both of the flight crew, and to ensure the effective communication of emergency or safety-related information, between flight and cabin crew members.

 <b>AIRBUS</b> <b>A330/A340</b> FLIGHT CREW TRAINING MANUAL	<b>NORMAL OPERATIONS</b>	02.010
	GENERAL	JAN 09/07

<b>HIGHLIGHTS</b>
-------------------

- (1) Ref to FCOM is corrected
- (2) Harmonization with the emergency calls from the CCOM

	<b>NORMAL OPERATIONS</b>  PRE START	02.020
		JAN 09/07

<b>MEL</b>
------------

R MSN 0002-0860

### **GENERAL**

The Master Minimum Equipment List (MMEL) is published by the aircraft manufacturer. It is a certified document that enables an aircraft to be dispatched, with some equipment, or functions inoperative. Some limitations, operational procedures and/or maintenance procedures may have to be performed. The Minimum Equipment List (MEL) is published by the operator, and approved by local authorities. It must be at least as restrictive as MMEL. The MMEL cannot be used to replace the MEL.

Aircraft can be dispatched with one, or more, secondary airframe part/parts missing. In this case, the flight crew must refer to the Configuration Deviation List (CDL), in the Aircraft Flight Manual.

### **MMEL PHILOSOPHY**

To introduce an item in the MMEL, the manufacturer must demonstrate first that the consequences of the system failure are no more than minor on the flight. The manufacturer must demonstrate then, that the next critical failure, i.e. the failure that has the most critical effect on aircraft operation when added to the initial failure, maintains the level of safety.

In some cases, this level of safety is maintained provided (o) or (m) procedures are observed.

As an example, the aircraft dispatch with one pack inoperative induces a flight level limitation whereas a pack failure in flight does not induce a flight level limitation.

### **ATA 100 FORMAT**

All items/equipment listed in the MEL are identified using the Air Transport Association (ATA) format. The ATA is the official reference for the classification of aircraft systems and/or functions. The aircraft systems/functions are classified with six digits. For example, 21-52-01 refers to:

21: ATA 21: Air conditioning

52: Air-cooling system

01: Air conditioning pack

### **MEL DESCRIPTION**

	<b>NORMAL OPERATIONS</b>	02.020
	<b>PRE START</b>	JAN 09/07

The MEL has four parts:

- . ECAM warnings/ MEL entry
- . List of items that may be inoperative for dispatch
- . Associated operational procedures
- . Associated maintenance procedures

### **MEL OPERATIONAL USE**

The MEL usually applies to revenue flights, and should be consulted before taxi out. If a failure occurs during taxi out, and before the take off roll starts, the decision to continue the flight is subject to pilot judgment and good airmanship. The Captain may consult the MEL before deciding to continue the flight (particularly if the failure has an effect on the takeoff performance).

During preliminary cockpit preparation, the flight crew must press the RCL P/B, for at least 3 seconds, in order to recall any previous cautions or warnings that have been cleared or cancelled. The flight crew should consult the technical logbook to confirm that the indications are compatible with the MEL.

A failure may occur if a Circuit Breaker (C/B) disengages. When on ground, do not re-engage any fuel pump C/Bs. The flight crew may re-engage any other tripped C/Bs, provided that the action is coordinated with the maintenance team, and the cause of the tripped C/B is identified.

The MMEL section 0 is called ECAM Warnings/MMEL Entry. The purpose of this section is to help the flight crew to determine the MMEL entry point, when an ECAM caution/warning message triggers. The ECAM Warnings/MMEL Entry section provides the relationship between the ECAM caution/warnings, and MMEL items, if applicable.

If a failed item does not appear in the MEL, it is not possible to dispatch the aircraft. However, items that do not affect the airworthiness of the aircraft, such as galley equipment, entertainment systems, or passenger convenience items, do not appear in the MEL. The dispatch applicability of these items is not relevant to the MEL.

In most cases, if the failed item appears in the MEL, the dispatch of the aircraft is authorized, provided that all dispatch conditions are fulfilled:

- . Check the rectification time interval has not expired
- . Consider location and, where repair is possible
- . (\*) Means that an INOP placard is required
- . (O) Means that a specific operational procedure or limitation is required (Refer to MEL chapter 2)

. (M) Means that a specific maintenance procedure is required.

When the MEL requires both maintenance and operational procedures, the maintenance procedures must be performed before applying the operational procedures.

### M MEL SYMBOL

AIRBUS MASTER MINIMUM EQUIPMENT LIST		01-21	P 7	
MASTER MINIMUM EQUIPMENT LIST		SEQ 001		
1. SYSTEM AND SEQUENCE NUMBERS	2. RECTIFICATION INTERVAL			
ITEM	C	3. NUMBER INSTALLED		
		4. NUMBER REQUIRED FOR DISPATCH	5. REMARKS OR EXCEPTIONS	
31-03 Outflow Valve	C	2	2	One automatic motor may be inoperative on each valve provided they are associated with the automatic cabin pressure control system 2.
31-04 Safety Valve	C	2	1 (m)	One may be inoperative in closed position provided : 1) Both automatic cabin pressure control systems are operative, and 2) The three motors on each outflow valve are operative.
31-05 Landing Elevation Selection	C	1	1 (*) (o)	AUTO function may be inoperative.

These symbols indicate requirements for a specific procedure:  
(m) maintenance,  
(o) operational,  
(\*) requires a placard in the cockpit.

FOF 02020 03875 0001

If some items are mandatory for ETOPS dispatch, a mention "ER" (Extended Range) is added but mandatory items for CATII, CATIII operations, RNP and RVSM may be not mentioned in the MMEL. However, the MEL should include these requirements. If it is not the case,

- . Mandatory items for CATII/III are available in QRH
- . Mandatory items for RVSM are available in FCOM 2.04.50
- . Mandatory items for RNP are available in FCOM 2.04.51

The ECAM STATUS page displays maintenance messages that are for maintenance purposes only. Dispatch with maintenance messages displayed on the ECAM STATUS page is permitted without specific conditions.

### SECURED AND TRANSIT STOP

	<b>NORMAL OPERATIONS</b>	02.020
	PRE START	JAN 09/07

R MSN 0002-0860

If the last checklist performed by the flight crew is SECURING THE AIRCRAFT C/L, the aircraft is in SECURED STOP. After a SECURED STOP, the flight crew must perform all items in the Standard Operations Procedure (SOP), for the next flight.

If the last checklist performed by the flight crew is PARKING C/L, the aircraft is in TRANSIT STOP.

After a TRANSIT STOP, items indicated by (\*), are the only steps to be completed for TRANSIT PREPARATION. i.e. PRELIMINARY COCKPIT PREPARATION, EXTERIOR INSPECTION, and COCKPIT PREPARATION.

### SAFETY EXTERIOR INSPECTION

R MSN 0002-0860

Safety Exterior Inspection is performed to ensure that the aircraft, and its surroundings, are safe for operations. Items that must be checked include:

- . Chocks in place
- . Doors status
- . Ground mechanic present
- . Aircraft environment

### PRELIMINARY COCKPIT PREPARATION

R MSN 0002-0860

### OBJECTIVES

	<b>NORMAL OPERATIONS</b>	02.020
	<b>PRE START</b>	JAN 09/07

The objectives of the preliminary cockpit preparation are:

- . To ensure that all safety checks are performed before applying electrical power:
  - The RCL pb is pressed for at least 3 seconds to display the cautions and warnings from the previous flight.
  - The technical logbook and the MEL are checked at this stage.
- . To check the liquid levels i.e. oil, hydraulic and oxygen pressure:
  - The HYD pb is pressed, to check the hydraulic level
  - The ENG pb is pressed, to check engine oil level ( Refer to FCOM 3.03.04)
  - The DOOR pb is pressed, to check the oxygen pressure level
- . To check the position of the surface control levers, for example, slats/flaps, and parking brake.

### **OXYGEN**

The ECAM S/D DOOR page displays the oxygen pressure. When the oxygen pressure is below a defined threshold, an amber half box highlights the value. This advises the flight crew that the bottle should be refilled. The flight crew should refer to the minimum flight crew oxygen pressure that is provided in the FCOM 3.01.35. The prolonged dispatch of the aircraft in such condition is not recommended.

### **EXTERIOR INSPECTION**

R MSN 0002-0860

Standard Operating Procedures (SOP) outline the various elements that the flight crew must review in greater detail. The objectives of the exterior inspection are:

- . To obtain a global assessment of the aircraft status. Any missing parts, or panels will be checked against the Configuration Deviation List (CDL) for possible dispatch, and any potential operational consequences.
- . To ensure that main control surfaces are in adequate position relative surface control levers.
- . To check that there are no leaks. For example, engine drain mast, hydraulic lines.
- . To check the status of the essential visible sensors, i.e. AOA, pitot and static probes.

	<b>NORMAL OPERATIONS</b>  PRE START	02.020
		JAN 09/07

- . To observe any possible abnormalities on the landing gear status:
  - Wheels and tires status (cut, wear, cracks)
  - Safety pins are removed
  - Brakes status (brake wear pin length with parking brake ON)
  - Length of oleo. Any difference between the two main landing gears must be reported. Typically, a 10 bars low pressure in oleo, leading to 60mm oleo reduction, decreases the tail clearance by approximately 1 ft.
- . To observe any possible abnormalities on the engines:
  - Fan blades, turbine exhaust, engine cowl and pylon status
  - Access door closed.

**ADIRS INITIALIZATION**

R MSN 0002-0390 0392-0393 0395-0415 0417-0448 0450-0452 0454-0456 0458-0470 0472-0477  
 0479-0484 0486-0491 0493-0498 0500-0519 0521-0559 0561-0562 0564-0571 0573-0574  
 0576-0600 0602-0603 0607 0609-0610 0614-0615 0618 0620-0621 0625-0627 0629-0636  
 0641-0643 0645-0646 0648-0649 0651-0652 0654-0658 0660-0666 0668-0671 0673-0675  
 0678-0679 0683 0687-0688 0690-0693 0695-0697 0699-0701 0704-0705 0707 0709 0712-0714  
 0716-0718 0720 0722 0724-0726 0728-0730 0732-0733 0735 0737 0739 0741-0742 0745  
 0747 0749 0752 0754-0755 0758 0769 0773-0774 0776-0778 0781-0782 0784 0786 0788  
 0791 0795-0796 0799 0802 0805-0806 0809 0814 0817-0818 0821-0824 0827-0828 0830  
 0832-0833 0836 0838 0840-0843 0847 0850-0859

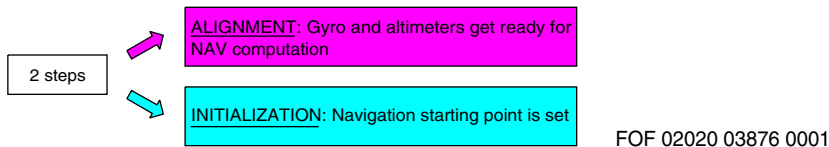

**ALIGNMENT**

At the beginning of the pre-flight checks, the crew sets the ADIRS selectors to NAV, in order to start alignment. The alignment takes approximately 10 minutes, and must be completed before pushback (before any aircraft movement).

**In transit:**



	<b>NORMAL OPERATIONS</b>  PRE START	02.020
		JAN 09/07

ADIRS re-alignment is only necessary, if one of the ADIRS displays a residual ground speed greater than 5 kt.

In this case, a rapid re-alignment should be performed on all 3 IRSs (by setting all the ADIRS to OFF, then all back to ON within 5 seconds). The fast alignment takes approximately one minute. It involves setting the ground speed to 0, and updating the IRS position to the position of the coordinates on the INITA page (usually airport reference coordinates). A complete re-alignment is only recommended for Long-range flights, especially if flown outside radio NAVAID coverage with Aircraft not equipped with GPS.

### **INITIALIZATION**

The F-PLN origin airport coordinates are extracted from the FMS database. These coordinates appear on the MCDU INITA page, and are normally used for initialization. They are the airport reference coordinates.

If a high navigation performance is desired, (i.e. for long-range flights without GPS and without radio navigation updates, or if low RNP operation is expected), the crew should adjust the airport reference coordinates to the gate coordinates, provided that this data is published or available on board. In this case, the flight crew should use the slew keys successively for Latitude and Longitude, instead of inserting the coordinates on the scratchpad, (in order to avoid errors).

When performing the BEFORE START C/L, the flight crew will check that the IRS IN ALIGN ECAM MEMO no longer appears, to indicate that the ADIRS are in NAV mode.

The crew will check on the POSITION MONITOR page, that the distance between IRS and FMS position is lower than 5NM. This will permit to detect any gross error for IRS initialization, which is not visible as long as GPS PRIMARY is available.

Checking runway and SID display on the ND in comparison with the aircraft symbol representing the aircraft present position, (ARC or NAV mode, range 10 NM) during taxi, is a good way to check the global consistency of FMGS entries (Position and flight plan).

### **"RESET IRS TO NAV" MCDU MESSAGE**

When the ADIRS are in NAV mode, and new origin airport coordinates are inserted, the RESET IRS TO NAV message triggers.

This occurs in transit, when the flight crew enters a new CO-RTE, or enters a new FROM-TO city pair on the INIT A page, and does not re-align the ADIRS.

In this case, check the coordinates on the INITA page and compare them with:

	<b>NORMAL OPERATIONS</b>  PRE START	02.020
		JAN 09/07

- . The coordinates of the origin airport, that are provided on the Airport chart, in order to detect a possible error in airport entry
- . The ADIRS position (IRS monitor page).

In most cases the ADIRS position and the airport position do not differ significantly. Therefore, the message may be cleared without realigning the IRSs.

R MSN 0391 0394 0416 0449 0453 0457 0471 0478 0485 0492 0499 0520 0560 0563 0572 0575 0601 0604-0606 0608 0611-0612 0616-0617 0619 0622-0624 0628 0637-0640 0644 0647 0650 0653 0659 0667 0672 0676-0677 0680-0682 0684-0686 0689 0694 0698 0702-0703 0706 0708 0710-0711 0715 0719 0721 0723 0727 0731 0734 0736 0738 0740 0743-0744 0746 0748 0750-0751 0753 0756-0757 0759-0768 0770-0772 0775 0779-0780 0783 0785 0787 0789-0790 0792-0794 0797-0798 0800-0801 0803-0804 0807 0810-0813 0815 0819-0820 0825-0826 0829 0831 0834-0835 0837 0839 0844-0846 0848-0849 0860

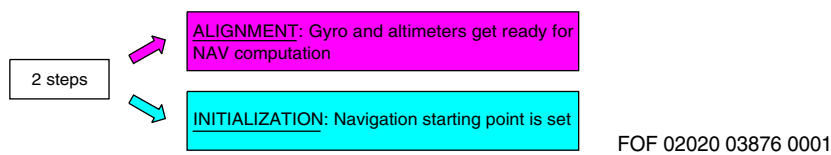

### ALIGNMENT

At the beginning of the pre-flight checks, the crew sets the ADIRS selectors to NAV, in order to start alignment. The alignment takes approximately 10 minutes, and must be completed before pushback (before any aircraft movement).

#### **In transit:**

ADIRS re-alignment is only necessary, if one of the ADIRS displays a residual ground speed greater than 5 kt.

In this case, a rapid re-alignment should be performed on all 3 IRSs (by setting all the ADIRS to OFF, then all back to ON within 5 seconds). The fast alignment takes approximately one minute. It involves setting the ground speed to 0, and updating the IRS position to the position of the coordinates on the INITA page (usually airport reference coordinates).

### INITIALIZATION

	<b>NORMAL OPERATIONS</b>	02.020
	PRE START	JAN 09/07

The ADIRS are automatically initialized at the GPS position. These GPS coordinates are displayed on the MCDU INIT A page, in replacement of the airport reference coordinates, after the pilot entered the FROM-TO city pair.

When performing the BEFORE START C/L, the crew will check that the IRS IN ALIGN ECAM MEMO has disappeared, as a confirmation that the ADIRS are in NAV mode.

Checking runway and SID display on the ND in comparison with the aircraft symbol representing the aircraft present position, (ARC or NAV mode, range 10 NM) during taxi, is a good way to check the global consistency of FMGS entries (Position and flight plan).

#### **"RESET IRS TO NAV" MCDU MESSAGE**

When the ADIRS are in NAV mode, and new origin airport coordinates are inserted, the RESET IRS TO NAV message triggers. This occurs, in transit, when the crew performs a fast alignment, since this fast alignment is usually completed before the crew enters the FROM-TO city pair.

Check the validity of the IRS initialization, before clearing this message.

### **COCKPIT PREPARATION**

R MSN 0002-0860

#### **FLOW PATTERN**

The scan pattern varies, depending on the pilot status, i.e PF, PNF, CM1, or CM2, and the areas of responsibility:

1. Overhead panel: Turn off any white lights (PF)
2. FMGS programming (PF)
3. Glare shield, ECP (CM1/2) and FCU (PF)
4. Lateral console (CM1/2)
5. Centre instrument panel and pedestal (PF)

#### **COCKPIT PREPARATION FLOW PATTERN**

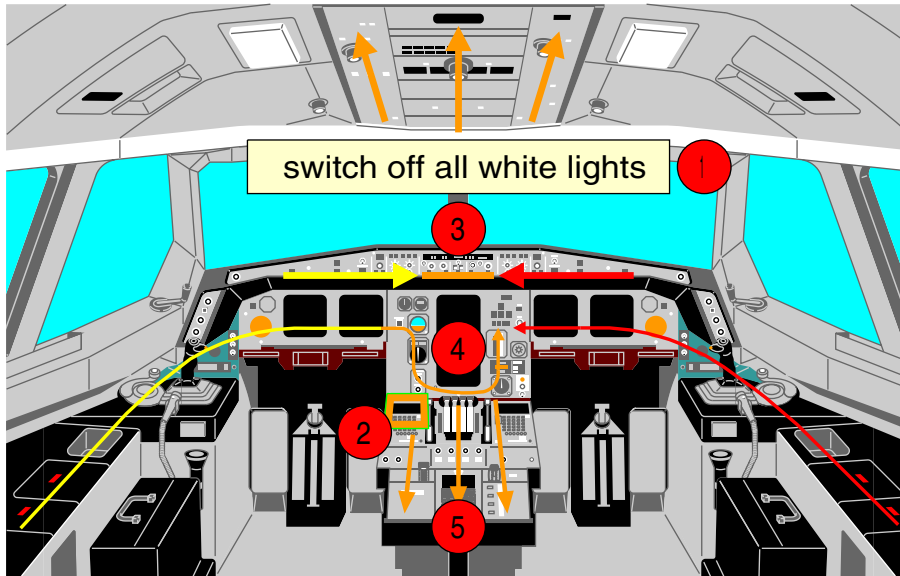

FOF 02020 03877 0001

### **FMGS PROGRAMMING**

FMGS programming involves inserting navigation data, then performance data. It is to be noted that:

- . Boxed fields must be filled
- . Blue fields inform the crew that entry is permitted
- . Green fields are used for FMS generated data, and cannot be changed
- . Magenta characters identify limits (altitude, speed or time), that FMS will attempt to meet
- . Yellow characters indicate a temporary flight plan display
- . Amber characters signify that the item being displayed is important and requires immediate action
- . Small font signifies that data is FMS computed
- . Large font signifies manually entered data.

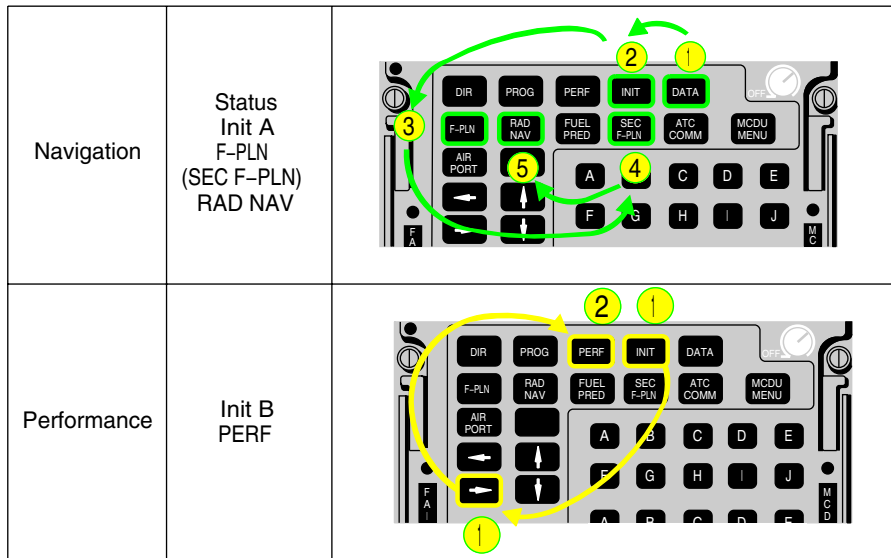

FOF 02020 03878 0001

The sequence-of-entry in the illustration above is the most practical.

To obtain correct predictions, the fields of the various pages must be completed correctly, with available planned data for the flight:

- DATA  
The database validity, NAVAIDs and waypoints (possibly stored in previous flight), and PERF FACTOR must be checked on the STATUS page.
- INIT A  
The INIT A page provides access to aircraft present position. The flight crew will check that it corresponds to the real aircraft position. (Refer to ADIRS INITIALIZATION part). The history wind is the vertical wind profile, that has been encountered during the previous descent and should be entered at this stage if it is representative of the vertical wind profile for the next flight.
- F-PLN  
The F-PLN A page is to be completed thoroughly including:
  - The take-off runway
  - SID
  - Altitude and speed constraints
  - Correct transition to the cruise waypoint
  - Intended step climb/descents, according to the Computerized Flight Plan (CFP).

	<b>NORMAL OPERATIONS</b>	02.020
	<b>PRE START</b>	JAN 09/07

If time permits, the wind profile along the flight plan may be inserted using vertical revision through wind prompt.

The flight crew should also check the overall route distance (6th line of the F-PLN page), versus CFP distance.

. SEC F-PLN

The SEC F-PLN should be used to consider an alternate runway for take-off, a return to departure airfield or a routing to a take-off alternate.

. RAD NAV

The RAD NAV page is checked, and any required NAVAID should be manually entered using ident. If a NAVAID is reported on NOTAM as unreliable, it must be deselected on the MCDU DATA/POSITION MONITOR/SEL NAVAID page.

. INIT B

The flight crew:

- Inserts the expected ZFWCG/ZFW, and block fuel to initialize a F-PLN computation.
- Checks fuel figures consistent with flight preparation fuel figures.

The flight crew will update weight and CG on receipt of the load sheet.

The FMS uses the trip wind for the entire flight from origin to destination. The trip wind is an average wind component that may be extracted from the CFP. The trip wind facility is available if the wind profile has not already been entered.

After Engine start, the INIT B page is no longer available. The flight crew should use the FUEL PRED page for weight and fuel data insertion, if required. The Init B page should not be completed immediately after Init A, because the FMGS would begin to compute F-PLN predictions. This would slow down the entry procedure.

. PERF

The thrust reduction altitude/acceleration altitude (THR RED /ACC) are set to default at 1500ft, or at a value defined by airline policy. The THR RED/ACC may be changed in the PERF TAKE-OFF page, if required. The flight crew should consider the applicable noise abatement procedure.

The one-engine-out acceleration altitude must:

- Be at least 400 ft above airport altitude
- Ensure that the net flight path is 35 ft above obstacles
- Ensure that the maximum time for takeoff thrust is not exceeded.

Therefore, there are generally a minimum and a maximum one-engine-out acceleration altitude values. The minimum value satisfies the first two criteria. The maximum value satisfies the last one. Any value between those two may be retained. The one-engine-out acceleration altitude is usually defaulted to 1500 ft AGL, and may be updated as required.

The flight crew uses the PERF CLB page to pre-select a speed. For example, "Green Dot" speed for a sharp turn after take-off.

The crew may also check on the PROG page the CRZ FL, MAX REC FL and OPT FL.

	<b>NORMAL OPERATIONS</b>	02.020
	<b>PRE START</b>	JAN 09/07

When the FMGS has been programmed, the PNF should then cross check the information before the take-off briefing. When the predictions are available, the crew may print the PREFLIGHT DATA. This print provides all the predictions that may be used during the initial part of the flight.

### **TAKE-OFF BRIEFING**

The PF should perform the takeoff briefing at the gate , when the flight crew workload permits, Cockpit preparation has been completed and, before engine start.

The takeoff briefing should be relevant, concise and chronological. When a main parameter is referred to by the PF, both flight crewmembers must crosscheck that the parameter has been set or programmed correctly. The takeoff briefing covers the following:

#### **TAKE OFF BRIEFING WITH ASSOCIATED CHECKS**

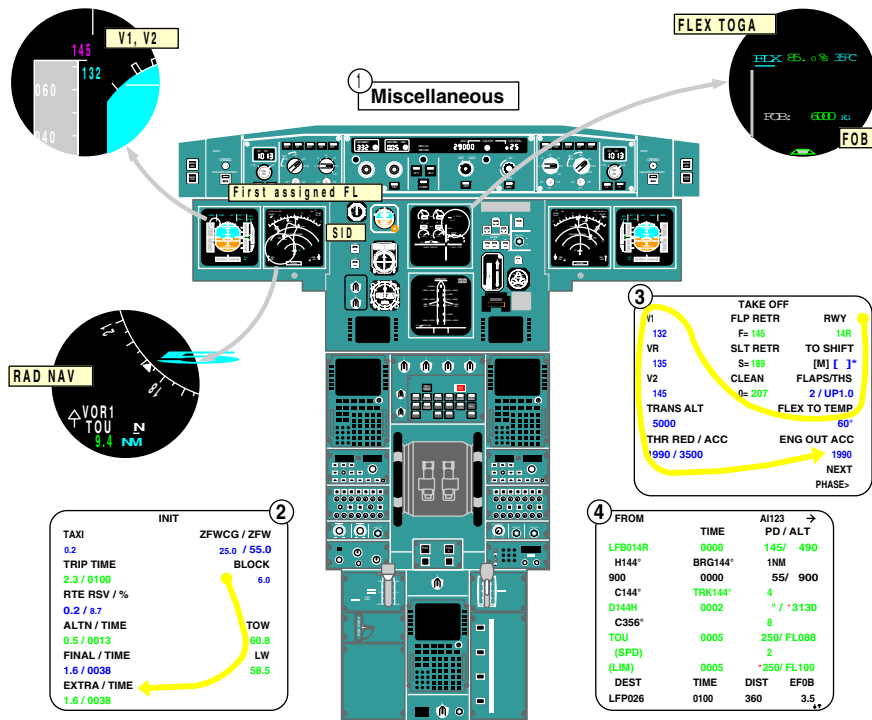

FOF 02020 03879 0001



Miscellaneous ①	Aircraft type and model (Tail strike awareness) Aircraft technical status (MEL and CDL considerations, relevant OEB) NOTAMS Weather RWY conditions Use of ENG/Wings Anti Ice ENG Start Procedure Push Back Expected Taxi Clearance Use of Radar Use of Packs for Takeoff
INT B PAGE ②	Block Fuel ( ) ..... (FOB on EW/D) Estimated TOW Extra time at destination
TAKEOFF PERF PAGE ③	T/O RWY T/O CONF FLEX / TOGA ( ) ..... FLEX TOGA on EW/D) V1, VR, V2 ( ) ..... (V1, V2 on PFD) TRANS ALT THR RED / ACC Altitude
FLIGHT PLAN ④	Minimum Safe Altitude First assigned FL ( ) ..... (altitude target in blue on PFD) Flight Plan description ( ) ..... (SID on MCDU FPLN page) RAD NAV ( ) ..... (RAD NAV on ND)
Abnormal operations	For any failure before V1: CAPT will call "STOP" or "GO" In case of failure after V1: Continue T/O, No action before 400ft AGL except gear up Reaching 400ft AGL, ECAM actions Reaching EO ACC altitude, Stop ECAM, Push for ALT, acceleration and clean up At green dor: OP CLB, MCT, continue ECAM, after T/O C/L, status ENG Out routing: EOSID, SID, radar vector, immediate return...

( ) items that must be cross-checked on associated display.

FOF 02020 03880 0001

### **FMS UPDATING**

When the load and trim sheet is available, the flight crew:

- . Updates the ZFWCG/ZFW

	<b>NORMAL OPERATIONS</b>  PRE START	02.020
		JAN 09/07

- . Checks that the TOW is consistent with the load sheet
  - . Checks the updated fuel figures
  - . Changes the FLEX TEMP and the take-off speeds as required
  - . Enters the THS position on the PERF TAKE OFF page
- When the predictions are available, the flight crew prints out the pre-flight data.

<b>MISCELLANEOUS</b>
----------------------

R MSN 0002-0860

**SEATING POSITION**

To achieve a correct seating position, the aircraft is fitted with an eye-position indicator on the centre windscreen post. The eye-position indicator has two balls on it. When the balls are superimposed on each other, they indicate that the pilot's eyes are in the correct position.

The flight crew should not sit too low, to avoid increasing the cockpit cut-off angle, therefore reducing the visual segment. During Low Visibility Procedures (LVP), it is important that the pilot's eyes are positioned correctly, in order to maximize the visual segment, and consequently, increase the possibility of achieving the required visual reference for landing as early as possible.

After adjusting the seat, each pilot should adjust the outboard armrest, so that the forearm rests comfortably on it, when holding the sidestick. There should be no gaps between the pilot's forearm and the armrest. The pilot's wrist should not be bent when holding the sidestick. This ensures that the pilot can accomplish flight maneuvers by moving the wrist instead of lifting the forearm from the armrest.

Symptoms of incorrect armrest adjustment include over-controlling, and not being able to make small, precise inputs.

The rudder pedals must then be adjusted to ensure the pilot can achieve both full rudder pedal displacement, and full braking simultaneously on the same side.

The armrest and the rudder pedals have position indicators. These positions should be noted and set accordingly for each flight.

**MCDU USE**

	NORMAL OPERATIONS  PRE START	02.020
		JAN 09/07

When clear for start-up and taxi, the PF displays the MCDU PERF TAKE OFF page, while the PNF displays the MCDU F-PLN page.

	<b>NORMAL OPERATIONS</b>  <b>START</b>	02.030
		JAN 09/07

**INTRODUCTION**

R MSN 0002-0860

Engines usually start using the Automatic Starting function. The Full Authority Digital Engine Control (FADEC) systems control this engine Automatic Starting function, and takes appropriate action, if engine parameters are exceeded. This function extends significantly the duration of engine life.

The thrust levers must be confirmed at "idle" before engine-start. If the thrust levers are not at "idle", the thrust increases above idle after engine-start, and can result in a hazardous situation. However, an ENG START FAULT ECAM warning triggers, to indicate that the flight crew must set the thrust levers to "idle".

**AUTOMATIC STARTING SEQUENCE**

R MSN 0012 0017 0030 0037 0045 0050 0054-0055 0059-0060 0062 0064-0073 0077 0082-0083 0086-0087 0095-0096 0098-0100 0102 0106-0113 0116 0118-0122 0127 0132 0138 0140 0143-0144 0148 0153 0155 0162 0165 0171-0172 0177 0181 0183-0184 0188-0189 0191 0195 0198 0200 0203 0205-0206 0209 0211 0219 0222-0224 0226 0229-0232 0234 0238 0240-0241 0244 0247-0251 0253-0256 0258-0259 0261-0262 0265-0267 0269 0271-0272 0275-0277 0279 0281 0283-0291 0293-0296 0299-0301 0303 0305-0306 0308-0309 0311-0317 0320 0322-0324 0326 0328 0330 0333-0334 0337-0346 0348-0351 0353 0356-0358 0361-0362 0364-0366 0368-0370 0372 0375 0380 0382 0384 0386 0388-0389 0392-0393 0396-0398 0400-0401 0403-0405 0407-0409 0412 0418-0423 0425 0427-0428 0432 0437 0439 0441 0443-0444 0448 0451-0452 0454-0456 0458 0461-0463 0465-0466 0469 0472-0473 0476-0477 0479-0481 0484 0486-0487 0489-0491 0493-0494 0496-0498 0500-0513 0515-0516 0518-0519 0521-0522 0524-0527 0529-0530 0532-0533 0535-0536 0539 0542 0548-0553 0555 0558 0564-0565 0567-0568 0570-0571 0573-0574 0576 0578-0579 0581 0584 0587-0588 0591-0597 0600 0602-0603 0605 0607 0609-0610 0612-0614 0616 0618 0620-0621 0623 0625 0627 0629 0631-0638 0640-0642 0644-0645 0647-0650 0652-0667 0669-0671 0673-0676 0678-0680 0682-0684 0686-0688 0690-0693 0695-0697 0699-0701 0703-0705 0707-0709 0711-0714 0716-0718 0720-0722 0724-0726 0728-0730 0732-0735 0737-0739 0741-0743 0745-0747 0749-0752 0754-0756 0758-0760 0769-0770 0772-0774 0776-0778 0780-0782 0784-0786 0788-0789 0791-0792 0795-0797 0799 0801-0803 0805-0811 0813-0828 0830-0834 0836 0838-0843 0845 0847 0849-0860

The engines are started in sequence, preferably engine 1 first, in order to pressurize the blue hydraulic system, that supplies the parking brake accumulator.

When the ENG START selector is set to "START", the FADECs are electrically-supplied. When there is sufficient BLEED PRESS, the PF begins the start sequence by setting the ENG MASTER switch to ON. The flight crew should monitor the start sequence:

	<b>NORMAL OPERATIONS</b>  <b>START</b>	02.030
		JAN 09/07

- . Start valve opens
- . N2 (or N3) increases
- . IGN A(B)
- . Fuel flow
- . EGT
- . N1
- . Oil pressure increases
- . Start valve closes.

After reaching the peak EGT, or when AVAIL is displayed, the PF can start engine 2

R MSN 0002-0011 0013-0016 0018-0029 0031-0035 0038-0044 0046-0049 0051-0053 0056-0058  
0061 0063 0074-0076 0078-0081 0084-0085 0088-0094 0097 0101 0103-0104 0114-0115 0117  
0123-0126 0128-0131 0133-0137 0139 0141-0142 0145-0147 0149-0152 0154 0156-0161  
0163-0164 0166-0170 0173-0176 0178-0180 0182 0185-0187 0190 0192-0194 0196-0197 0199  
0201-0202 0204 0207-0208 0210 0212-0218 0220-0221 0225 0227-0228 0233 0235-0237  
0239 0242-0243 0245-0246 0252 0257 0260 0263-0264 0268 0270 0273-0274 0278 0280  
0282 0292 0297 0302 0304 0307 0310 0318-0319 0321 0325 0327 0329 0331-0332  
0335 0347 0352 0354-0355 0359 0363 0367 0371 0373-0374 0376-0379 0381 0383 0385  
0387 0390-0391 0394-0395 0399 0402 0406 0410-0411 0413-0417 0424 0426 0429-0431  
0433-0436 0438 0440 0442 0445-0447 0449-0450 0453 0457 0459-0460 0464 0467-0468  
0470-0471 0474-0475 0478 0482-0483 0485 0488 0492 0495 0499 0514 0517 0520 0523  
0528 0531 0534 0537-0538 0540-0541 0543-0547 0554 0556-0557 0559-0563 0566 0569  
0572 0575 0577 0580 0582-0583 0585-0586 0590 0598 0601 0604 0606 0608 0611 0615  
0617 0619 0622 0624 0626 0628 0630 0639 0643 0646 0651 0668 0672 0677 0681 0685  
0689 0694 0698 0702 0706 0710 0715 0719 0723 0727 0731 0736 0740 0744 0748 0753  
0757 0761-0768 0771 0775 0779 0783 0787 0790 0793-0794 0798 0800 0804 0812 0829  
0835 0837 0844 0846 0848

The APU bleed allows to start two engines simultaneously. However, the ENG MASTER switches have to be set ON with a certain delay (Delta N2 about 10%), in order to allow a proper functioning of the NO Break Power Transfer function of the electrical generators, and therefore, avoid electrical transients on computers and display units.

Engine 1 and 2 should be started first, in order to pressurize the blue hydraulic system, that supplies the parking brake accumulator.

When the ENG START selector is set to "START", the FADECs are electrically-supplied. When there is sufficient BLEED PRESS, the PF begins the start sequence by setting the ENG MASTER switches to ON, one after the other with a slight delay (N2 about 10%). The flight crew should monitor the start sequence:

	<b>NORMAL OPERATIONS</b>  START	02.030
		JAN 09/07

- . Start valve opens
- . N2 (or N3) increases
- . IGN A(B)
- . Fuel flow
- . EGT
- . N1
- . Oil pressure increases
- . Start valve closes.

After reaching the peak EGT, or when AVAIL is displayed, the PF can start engines 3 and 4.

R MSN 0002-0860

#### **AFTER ENGINE START**

The flight crew should check the relative engine vibration level.

When the ENG START selector is set to NORM, the packs return to the OPEN position. APU Bleed should immediately be turned off, to avoid engine ingestion of exhaust gas.

If the start is not successful, the flight crew must use the ECAM as usually done, and avoid instinctively selecting the ENG MASTER switch to OFF. This would interrupt the FADEC protective actions (e. g. cranking after hot start).

#### **AVERAGE IDLE ENGINE PARAMETERS**

R MSN 0050 0060 0062 0064-0069 0072-0073 0077 0082 0087 0095-0096 0100 0107 0110  
 0112 0116 0119-0120 0122 0127 0143 0162 0171-0172 0181 0195 0206 0209 0219  
 0222-0224 0226 0229-0232 0238 0240-0241 0247 0249 0253 0255-0256 0258-0259 0262  
 0267 0275 0288-0291 0294 0296 0299-0300 0305 0308 0312 0315 0317 0322-0324 0333  
 0337-0338 0342-0343 0346 0350-0351 0353 0358 0361-0362 0364 0366 0368 0370 0375  
 0380 0388 0403 0425 0428 0432 0444 0454 0469 0476 0484 0490 0493 0524 0533 0542  
 0549-0550 0552 0578 0588 0591 0609 0614 0618 0620-0621 0631 0633 0640 0663 0665  
 0674 0676 0690 0708 0718 0722 0739 0758 0772 0778 0784 0796 0799 0802-0803 0806  
 0817 0822 0827-0828 0843 0845 0857-0859

As soon as the engine-start is complete, the flight crew should check the stabilized parameters. At ISA sea level:

EPR about 1.015, EGT about 320 ° C, N1 about 23%, N2 about 59%, FF about 580 kg/h-1280lb/h.

R MSN 0012 0017 0071 0083 0098-0099 0102 0106 0109 0111 0113 0118 0121 0132 0138  
 0140 0144 0148 0153 0155 0165 0177 0234 0244 0248 0250-0251 0254 0261 0265-0266  
 0271 0276-0277 0279 0281 0283-0287 0293 0295 0301 0303 0306 0309 0311 0313-0314  
 0316 0320 0326 0328 0334 0340 0344-0345 0348-0349 0356-0357 0365 0369 0372 0382  
 0384 0386 0389 0392-0393 0396 0398 0400-0401 0404-0405 0407-0409 0412 0418-0421 0423  
 0427 0437 0439 0451-0452 0455-0456 0461-0462 0479-0480 0491 0494 0496-0497 0501  
 0505 0509 0512 0515 0518 0525-0527 0529 0532 0536 0539 0548 0551 0565 0568 0570  
 0576 0579 0581 0597 0600 0610 0625 0627 0629 0632 0635-0636 0642 0645 0648-0649  
 0652 0654 0656 0658 0662 0664 0666 0669-0670 0673 0679 0683 0687-0688 0692 0696  
 0701 0709 0713 0716-0717 0720 0724 0726 0728-0730 0732 0735 0737 0741 0750-0751  
 0756 0759 0773 0776-0777 0780-0782 0785-0786 0788 0791 0795 0797 0807-0810 0815  
 0818 0821 0824 0830 0832-0833 0836 0839-0840 0850-0852 0854-0855 0860

As soon as the engine-start is complete, the flight crew should check the stabilized parameters. At ISA sea level:

EPR about 1.015, EGT about 380 ° C, N1 about 23%, N2 about 47%, N3 about 63%, FF about 820 kg/h-1800lb/h.

R MSN 0030 0037 0045 0054-0055 0059 0070 0086 0183-0184 0188-0189 0191 0198 0200  
 0203 0205 0211 0269 0272 0330 0339 0397 0422 0441 0443 0448 0458 0463 0465-0466  
 0472-0473 0477 0481 0486-0487 0489 0498 0500 0502-0504 0506-0508 0510-0511 0513  
 0516 0519 0521-0522 0530 0535 0553 0555 0558 0564 0567 0571 0573-0574 0584  
 0587 0593-0595 0602-0603 0605 0607 0612 0616 0623 0634 0637-0638 0641 0644 0647  
 0650 0653 0655 0657 0659-0661 0667 0671 0675 0678 0680 0682 0684 0686 0691  
 0693 0695 0697 0699-0700 0703-0705 0707 0711-0712 0714 0721 0725 0733-0734 0738  
 0742-0743 0745-0747 0749 0752 0754-0755 0760 0769-0770 0774 0789 0792 0801 0805  
 0811 0813-0814 0819-0820 0823 0825-0826 0831 0834 0838 0841-0842 0847 0849 0853

As soon as the engine-start is complete, the flight crew should check the stabilized parameters. At ISA sea level:

	<b>NORMAL OPERATIONS</b>  <b>START</b>	02.030
		JAN 09/07

N1 about 23%, EGT about 360 ° C, N2 about 63%, FF about 550 kg/h-1210lb/h.

R MSN 0002-0011 0013-0016 0018-0029 0031-0035 0038-0044 0046-0049 0051-0053 0056-0058  
0061 0063 0074-0076 0078-0081 0084-0085 0088-0094 0097 0101 0103-0104 0114-0115 0117  
0123-0126 0128-0131 0133-0137 0139 0141-0142 0145-0147 0149-0152 0154 0156-0161  
0163-0164 0166-0170 0173-0176 0178-0180 0182 0185-0187 0190 0192-0194 0196-0197 0199  
0201-0202 0204 0207-0208 0210 0212-0218 0220-0221 0225 0227-0228 0233 0235-0237  
0239 0242-0243 0245-0246 0252 0257 0260 0263-0264 0268 0270 0273-0274 0278 0280  
0282 0292 0297 0302 0304 0307 0310 0318-0319 0321 0325 0327 0329 0331-0332 0335  
0347 0352 0354-0355 0359 0363 0367 0373-0374 0377-0379 0381 0385 0387 0390 0395  
0399 0402 0406 0411 0413-0415 0424 0429-0430 0433-0435 0438 0442 0446-0447 0450  
0459 0467 0470 0474 0483 0528 0538 0541 0544-0546 0554 0556 0559 0561-0562 0582  
0585 0590 0598 0643 0646 0651 0668 0793 0800 0835 0844

As soon as the engine-start is complete, the flight crew should check the stabilized parameters. At ISA sea level:

N1 about 20%, EGT about 400 ° C, N2 about 60%, FF about 300 kg/h-660lb/h.

R MSN 0371 0376 0383 0391 0394 0410 0416-0417 0426 0431 0436 0440 0445 0449 0453  
0457 0460 0464 0468 0471 0475 0478 0482 0485 0488 0492 0495 0499 0514 0517 0520  
0523 0531 0534 0537 0540 0543 0547 0557 0560 0563 0566 0569 0572 0575 0577 0580  
0583 0586 0601 0604 0606 0608 0611 0615 0617 0619 0622 0624 0626 0628 0630 0639  
0672 0677 0681 0685 0689 0694 0698 0702 0706 0710 0715 0719 0723 0727 0731 0736  
0740 0744 0748 0753 0757 0761-0768 0771 0775 0779 0783 0787 0790 0794 0798 0804  
0812 0829 0837 0846 0848

As soon as the engine-start is complete, the flight crew should check the stabilized parameters. At ISA sea level:

EPR about 1.00, EGT about 380 ° C, N1 about 17%, N2 about 48%, N3 about 59%, FF about 480 kg/h-1040lb/h.

**ENGINE START MALFUNCTION**

R MSN 0002-0860

Following an aborted engine start, the crew will consider an engine dry cranking prior resuming a new engine start attempt. Starter limitations in FCOM 3.01.70 must be observed.



	<b>NORMAL OPERATIONS</b>  START	02.030
		JAN 09/07

### MANUAL ENGINE START

R MSN 0002-0860

The flight crew should only perform a manual start if:

- . The EGT margins are low
- . The residual EGT is high
- . A dry crank is performed.

It may be appropriate to perform a manual start in high altitude operations, or after an aborted engine start.

The MANUAL ENGINE START procedure is a "read and do" procedure. Refer to the FCOM 3.04.70 before starting a manual engine start.

The FADEC has limited control over the manual start process. It ensures that the engine start valve closes at 50% N2. It monitors engine parameters, and generates an associated warning when necessary.

It is recommended that the flight crew use the stopwatch to ensure that the starter engagement time remains within the limits.

### TAILPIPE FIRE

R MSN 0002-0860

An engine tailpipe fire may occur at engine-start, and may be the result of either excess fuel in the combustion chamber, or an oil leak in the low-pressure turbine. A tailpipe fire is an internal fire within the engine. No critical areas are affected.

If the ground crew reports a tailpipe fire, the flight crew must perform the following actions:

- . Shut down the engine (MASTER switch set to OFF)
- . Do NOT press the ENG FIRE pushbutton
- . Crank the engine, by using either the bleed opposite the engine, the APU bleed, or external pneumatic power (Set ENG START selector to CRANK, then set the MAN START switch to ON).

	<b>NORMAL OPERATIONS</b>	02.030
	START	JAN 09/07

Do NOT use the ENG FIRE pushbutton, this would stop power to the FADECs, and would stop the motoring sequence. The fire extinguisher must not be used, as it will not extinguish an internal engine fire. As a first priority, the engine must be ventilated.

If the ground crew reports a tailpipe fire, and bleed air is not readily available, a ground fire-extinguisher should can be used as last resort: Chemical or dry chemical powder causes serious corrosive damage to the engine.

### **ENGINE WARM-UP PERIOD**

R MSN 0002-0860

After engine-start, and in order to avoid thermal shock of the engine, the engine should be operated at idle or near idle (Ref. FCOM 3.03.09) before setting the thrust lever to high power. The warm-up can include any taxi time at idle.

### **AFTER START FLOW PATTERN**

R MSN 0002-0860

When the engines have started, the PF sets the ENG START selector to NORM to permit normal pack operation. At this time, the After Start Flow Pattern begins.

#### AFTER START FLOW PATTERN

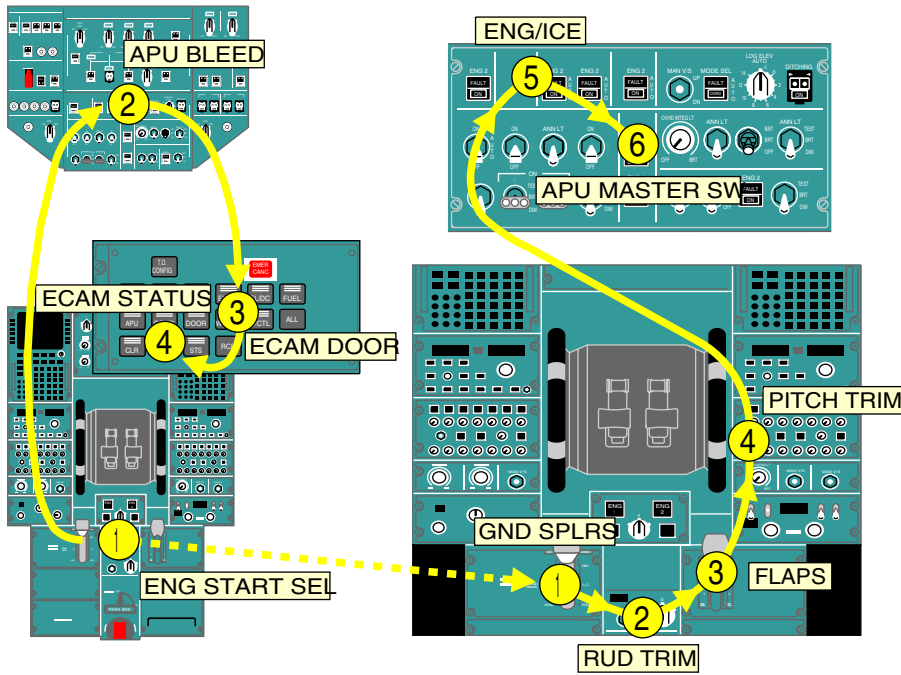

FOF 02030 03881 0001

	<b>NORMAL OPERATIONS</b>  TAXI	02.040
		JAN 09/07

R MSN 0002-0860

**TAXI ROLL AND STEERING**

Before taxi, check that the amber "NWS DISC" ECAM message is off, to ensure that steering is fully available.

**THRUST USE**

Only a little power is needed above thrust idle, in order to get the aircraft moving (N1 40%). Excessive thrust application can result in exhaust-blast damage or Foreign Object Damage (FOD). Thrust should normally be used symmetrically.

**TILLER AND RUDDER PEDALS USE**

Pedals control nosewheel steering at low speed ( $\pm 6$  degrees with full pedal deflection). Therefore, on straight taxiways and on shallow turns, the pilot can use the pedals to steer the aircraft, keeping a hand on the tiller. In sharper turns, the pilot must use the tiller.

**STEERING TECHNIQUE**

Nosewheel steering is "by-wire" with no mechanical connection between tiller and the nosewheel. The relationship between tiller deflection and nosewheel angle is not linear and the tiller forces are light.

**TILLER DEFLECTION VS NOSEWHEEL STEERING ANGLE**

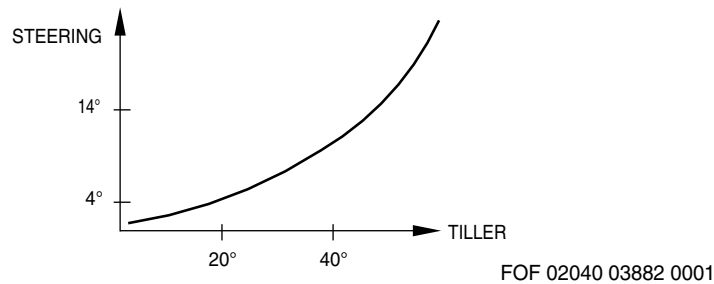

Therefore, the PF should move the tiller smoothly and maintain the tiller's position. Any correction should be small and smooth, and maintained for enough time to enable the pilot to assess the outcome. Being over-active on the tiller will cause uncomfortable oscillations.

On straight taxiways, the aircraft is correctly aligned on the centerline, when the centerline is lined-up between the PFD and ND.

CORRECTLY FOLLOWING THE CENTERLINE

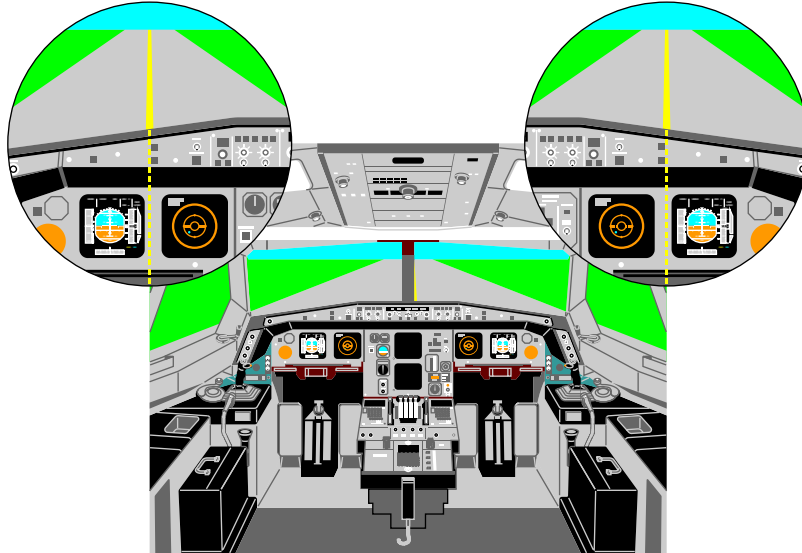

FOF 02040 03883 0001

If both pilots act on the tiller or pedals, their inputs are added until the maximum value of the steering angle (programmed within the BSCU) is reached.

When the seating position is correct, the cut-off angle is 20 degrees, and the visual ground geometry provides an obscured segment of 53 feet (16.15 meters). During taxi, a turn must be initiated before an obstacle approaches the obscured segment. This provides both wing and tail clearance, with symmetric thrust and no differential braking.

Asymmetric thrust can be used to initiate a tight turn and to keep the aircraft moving during the turn. If nosewheel lateral skidding occurs while turning, reduce taxi speed or increase turn radius. Avoid stopping the aircraft in a turn, because excessive thrust will be required to start the aircraft moving again.

The flight crew should be aware that the main gear on the inside of a turn will always cut the corner and track inside of the nosewheel track. For this reason, over-steer must be used.

OVERSTEERING TECHNIQUE

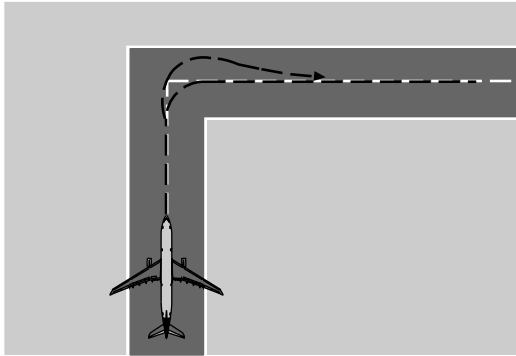

FOF 02040 03884 0001

When exiting a tight turn, the PF should anticipate the steer out. Additionally, the PF should allow the aircraft to roll forward for a short distance to minimize the stress on the main gears.

In the event that one or more tires is/are deflated on the main landing gear, the maximum permitted steering angle will be limited by the aircraft speed. Therefore, with one tire deflated, the aircraft speed is limited to 7 knots and nosewheel steering can be used. With two tires deflated, the aircraft speed is limited to 3 knots and nosewheel steering angle should be limited to 30 degrees.

For turns of 90 degrees or more, the aircraft speed should be less than 10 knots.

### **180 DEGREE TURN**

In order to make an effective 180-degree turn, the Captain should proceed as follows:

- . Taxi on the right-hand side of the runway, and turn left to establish a 20-degree divergence from the runway axis (using the ND or the PFD). The maximum ground speed is 10 knots.
- . When the aircraft is physically over the edge of the runway, smoothly initiate a full-deflection turn to the right.
- . Asymmetric thrust should be used during the turn. Anticipation is required to ensure that asymmetric thrust is established, before starting the turn [50%N1 or 1.05EPR], in order to maintain a continuous speed of approximately 8 knots throughout the maneuver.
- . During the turn, it is essential to maintain minimum ground speed. This will avoid the need to significantly increase thrust, in order to continue moving.

When the aircraft is turning, the PNF should observe the ND, and call out the indicated Ground Speeds (GS)

- Differential braking is not recommended, to prevent stress on the landing gear assembly. In addition, a braked pivot-turn is **NOT** permitted (i.e. braking to fully stop the wheels on one main gear).
- When turning on a wet or contaminated runway, (and to be more specific, when turning on the white or yellow marking that is painted on the runway) tight turns can cause the nosewheel to jerk. This can be noisy and uncomfortable.

The First Officer symmetrically performs the procedure (i.e. Taxi on the left-hand side of the runway).

**AIRCRAFT DIMENSIONS**

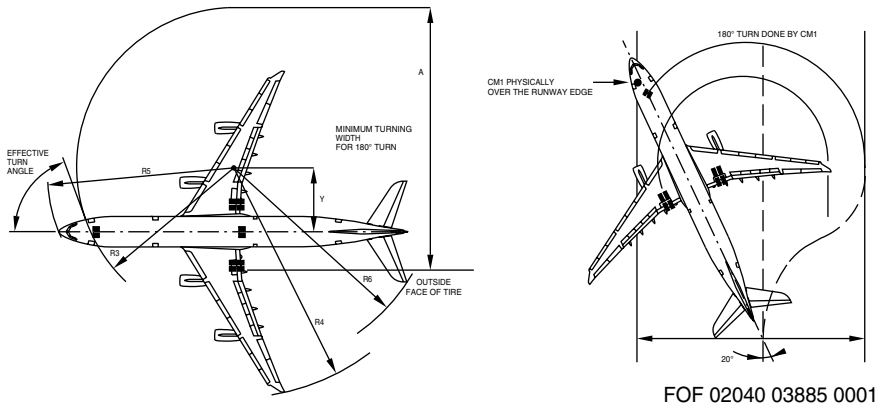

FOF 02040 03885 0001

**FIGURES**

MSN 0012 0017 0030 0037 0045 0050 0054-0055 0059-0060 0062 0064-0073 0077 0083 0086-0087 0095-0096 0098-0100 0102 0106-0113 0116 0118-0122 0127 0132 0138 0140 0143-0144 0148 0153 0155 0162 0165 0171-0172 0177 0183-0184 0188-0189 0191 0198 0200 0203 0206 0209 0219 0224 0231 0234 0241 0244

Y	R3	R4	R5	R6	NWS Limit Angle	Minimum Runway Width with Asymmetric Thrust

	<b>NORMAL OPERATIONS</b>	02.040
	TAXI	JAN 09/07

15 m 47 ft	30 m 96 ft	46 m 150 ft	35 m 116 ft	40 m 131 ft	65 degrees	<b>53 m 171 ft</b>
---------------	---------------	----------------	----------------	----------------	------------	------------------------

R MSN 0181 0195 0205 0211 0222-0223 0226 0229-0230 0232 0238 0240 0247-0251  
0253-0255 0258-0259 0261-0262 0265-0266 0269 0271-0272 0275-0276 0281 0283 0285-0291  
0293-0296 0299-0301 0303 0305-0306 0308-0309 0311-0314 0316-0317 0320 0322 0324  
0326 0328 0330 0334 0339-0340 0343 0345 0348 0353 0358 0361-0362 0364-0366 0369  
0372 0382 0384 0392 0396-0398 0401 0403-0404 0409 0422 0427 0432 0437 0441  
0443-0444 0448 0451-0452 0454-0456 0458 0461-0463 0465-0466 0469 0472-0473 0476-0477  
0480-0481 0486-0487 0489 0491 0493-0494 0498 0500-0511 0513 0516 0518-0519 0521-0522  
0525-0527 0529-0530 0532 0535-0536 0551 0555 0567 0571 0573 0584 0587 0597 0600  
0605 0609-0610 0612-0614 0616 0618 0620-0621 0625 0627 0631-0635 0638 0644 0647  
0649-0650 0652-0653 0655-0658 0660-0661 0664-0667 0678 0682-0684 0686 0688 0693  
0696-0697 0700 0703-0704 0709 0717-0718 0722 0724 0726 0728-0730 0732-0733 0735  
0737-0739 0742-0743 0745-0747 0749-0751 0754-0756 0759-0760 0770 0774 0778 0780  
0785 0788 0792 0795-0797 0801-0802 0807-0811 0814-0815 0818-0822 0824-0825 0828  
0831-0832 0834 0839-0842 0849 0852-0854 0860

Y	R3	R4	R5	R6	NWS Limit Angle	Minimum Runway Width with Asymmetric Thrust
12 m 39 ft	26 m 85 ft	43 m 141 ft	31 m 101 ft	37 m 121 ft	72 degrees	<b>42 m 136 ft</b>

R MSN 0082 0256 0267 0277 0279 0284 0315 0323 0333 0337-0338 0342 0344 0346  
0349-0351 0356-0357 0368 0370 0375 0380 0386 0388-0389 0393 0400 0405 0407-0408  
0412 0418-0421 0423 0425 0428 0439 0479 0484 0490 0496-0497 0512 0515 0524  
0533 0539 0542 0548-0550 0552-0553 0558 0564-0565 0568 0570 0574 0576 0578-0579  
0581 0588 0591-0595 0602-0603 0607 0623 0629 0636-0637 0640-0642 0645 0648 0654  
0659 0662-0663 0669-0671 0673-0676 0679-0680 0687 0690-0692 0695 0699 0701 0705  
0707-0708 0711-0714 0716 0720-0721 0725 0734 0741 0752 0758 0769 0772-0773 0776-0777  
0781-0782 0784 0786 0789 0791 0799 0803 0805-0806 0813 0817 0823 0826-0827 0830  
0833 0836 0838 0843 0845 0847 0850-0851 0855-0859

Y	R3	R4	R5	R6	NWS Limit Angle	Minimum Runway Width with Asymmetric Thrust
12 m 39 ft	27 m 88 ft	44 m 144 ft	33 m 108 ft	38 m 124 ft	72 degrees	<b>46 m 151 ft</b>



R MSN 0002-0003 0005 0007 0013 0015-0016 0020 0023-0025 0027-0029 0032-0035 0039-0041 0044 0047-0049 0051-0053 0056-0058 0076 0078-0079 0084 0088-0094 0097 0101 0103-0104 0114-0115 0117 0123-0126 0128-0131 0133-0137 0139 0141-0142 0145-0147 0149-0150 0152 0154 0157-0158 0160-0161 0163-0164 0166-0170 0173-0176 0179-0180 0182 0185-0187 0190 0192-0194 0196-0197 0199 0201-0202 0207-0208 0210 0212-0218 0220-0221 0225 0227-0228 0233 0235-0237 0239 0242-0243 0245-0246 0252 0257 0260 0263-0264 0268 0270 0273-0274 0278 0280 0282 0292 0297 0302 0304 0307 0310 0318-0319 0321 0325 0327 0329 0331-0332 0335 0347 0352 0354-0355 0359 0363 0367 0373-0374 0377-0379 0381 0385 0387 0390 0395 0399 0402 0406 0411 0413-0415 0424 0429-0430 0433-0435 0438 0442 0446-0447 0450 0459 0467 0470 0474 0483 0528 0538 0541 0544-0546 0554 0556 0559 0561-0562 0582 0585 0590 0598 0643 0646 0651 0668 0793 0800 0835 0844

Y	R3	R4	R5	R6	NWS Limit Angle	Minimum Runway Width with Asymmetric Thrust
13 m 43 ft	29 m 100 ft	44m 144 ft	35 m 114 ft	39 m 128 ft	72 degrees	<b>45 m 148 ft</b>

MSN 0004 0006 0008-0011 0014 0018-0019 0021-0022 0026 0031 0038 0043 0046 0061 0063 0074-0075 0080-0081 0085 0151 0156 0159 0178 0204

Y	R3	R4	R5	R6	NWS Limit Angle	Minimum Runway Width with Asymmetric Thrust
13 m 42 ft	27 m 88 ft	44 m 144 ft	33 m 108ft	34 m 111 ft	72degrees	<b>41 m 135 ft</b>

R MSN 0394 0445 0457 0464 0471 0478 0485 0492 0495 0499 0520 0560 0563 0572 0608 0611 0624 0628 0685 0694 0698 0748 0757 0761 0775 0783

Y	R3	R4	R5	R6	NWS Limit Angle	Minimum Runway Width with Asymmetric Thrust
14 m 46 ft	32 m 105 ft	47 m 154 ft	37 m 122 ft	42 m 138 ft	70 degrees	<b>52 m 171 ft</b>

	<b>NORMAL OPERATIONS</b>  TAXI	02.040
		JAN 09/07

R MSN 0371 0376 0383 0391 0410 0416-0417 0426 0431 0436 0440 0449 0453 0460 0468  
0475 0482 0488 0514 0517 0523 0531 0534 0537 0540 0543 0547 0557 0566 0569 0575  
0577 0580 0583 0586 0601 0604 0606 0615 0617 0619 0622 0626 0630 0639 0672 0677  
0681 0689 0702 0706 0710 0715 0719 0723 0727 0731 0736 0740 0744 0753 0762-0768  
0771 0779 0787 0790 0794 0798 0804 0812 0829 0837 0846 0848

Y	R3	R4	R5	R6	NWS Limit Angle	Minimum Runway Width with Asymmetric Thrust
15 m 51 ft	37 m 122 ft	48 m 158 ft	43 m 140 ft	45 m 147 ft	76 degrees	<b>55 m</b> <b>181 ft</b>

**TAXI CAMERA**

R MSN 0371 0376 0383 0391 0410 0416-0417 0426 0431 0436 0440 0449 0453 0460 0468  
0475 0482 0488 0495 0514 0517 0523 0531 0534 0537 0540 0543 0547 0557 0566 0569  
0575 0577 0580 0583 0586 0601 0604 0606 0615 0617 0619 0622 0626 0630 0639 0672  
0677 0681 0689 0702 0706 0710 0715 0719 0723 0727 0731 0736 0740 0744 0748 0753  
0757 0761-0768 0771 0779 0783 0787 0790 0794 0798 0804 0812 0829 0837 0846 0848

The Taxi Aid Camera System (TACS) is designed to assist the flight crew by determining the nose and main gear position before and during taxi. Looking out of the cockpit window remains the primary means of determining when to initiate turns, and of verifying the aircraft's position relative to the ground track.

The TACS can assist the flight crew during pushback: The flight crew is able to see and check that the tow truck is connected, that the aircraft's environment is clear of obstacles, and that the ground crew personnel is in the appropriate position.

The magenta squares on the upper TACS display, help the flight crew initiate turns with a correct over-steer.

When the turn is established, the aircraft is correctly turning if the wing root continues over the yellow line.

USE OF TACS

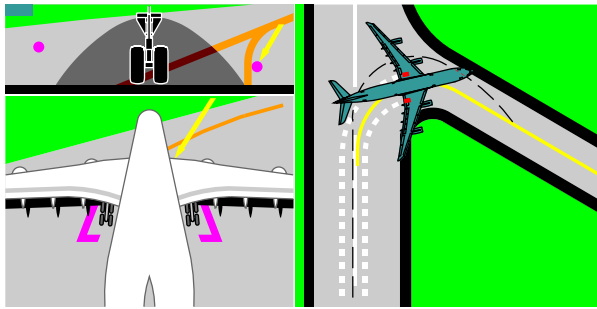

FOF 02040 03886 0001

During taxi, the flight crew can monitor how close the wheels are to the edges of the runway, by referring to the bottom TACS image.

To correctly turn and taxi, flight crew must primarily refer to external cues. The TACS is merely a tool that assists the flight crew, and is an MEL "GO" item.

**BRAKE CHECK**

R MSN 0002-0370 0372-0375 0377-0382 0384-0390 0392-0393 0395-0409 0411-0415 0418-0425  
 0427-0430 0432-0435 0437-0439 0441-0444 0446-0448 0450-0452 0454-0456 0458-0459  
 0461-0463 0465-0467 0469-0470 0472-0474 0476-0477 0479-0481 0483-0484 0486-0487  
 0489-0491 0493-0494 0496-0498 0500-0513 0515-0516 0518-0519 0521-0522 0524-0530  
 0532-0533 0535-0536 0538-0539 0541-0542 0544-0546 0548-0556 0558-0559 0561-0562  
 0564-0565 0567-0568 0570-0571 0573-0574 0576 0578-0579 0581-0582 0584-0585 0587-0600  
 0602-0603 0605 0607 0609-0610 0612-0614 0616 0618 0620-0621 0623 0625 0627 0629  
 0631-0638 0640-0671 0673-0676 0678-0680 0682-0684 0686-0688 0690-0693 0695-0697  
 0699-0701 0703-0705 0707-0709 0711-0714 0716-0718 0720-0722 0724-0726 0728-0730  
 0732-0735 0737-0739 0741-0743 0745-0747 0749-0752 0754-0756 0758-0760 0769-0770  
 0772-0774 0776-0778 0780-0782 0784-0786 0788-0789 0791-0793 0795-0797 0799-0803  
 0805-0811 0813-0828 0830-0836 0838-0845 0847 0849-0860

When cleared to taxi, the PF should set the Parking Brake to "OFF". When the aircraft starts to move, the PF should check the efficiency of the normal braking system by gently pressing the brake pedals, to ensure that the aircraft slows down. The PNF should also check the triple brake indicator to ensure that brake pressure drops to zero. This indicates a successful changeover to the normal braking system.

	<b>NORMAL OPERATIONS</b>  TAXI	02.040
		JAN 09/07

R MSN 0371 0376 0383 0391 0394 0410 0416-0417 0426 0431 0436 0440 0445 0449 0453  
0457 0460 0464 0468 0471 0475 0478 0482 0485 0488 0492 0495 0499 0514 0517 0520  
0523 0531 0534 0537 0540 0543 0547 0557 0560 0563 0566 0569 0572 0575 0577 0580  
0583 0586 0601 0604 0606 0608 0611 0615 0617 0619 0622 0624 0626 0628 0630 0639  
0672 0677 0681 0685 0689 0694 0698 0702 0706 0710 0715 0719 0723 0727 0731 0736  
0740 0744 0748 0753 0757 0761-0768 0771 0775 0779 0783 0787 0790 0794 0798 0804  
0812 0829 0837 0846 0848

When cleared to taxi, the PF should set the Parking Brake to "OFF". When the aircraft starts to move, the PF should check the efficiency of the normal braking system by gently pressing the brake pedals.

**CARBON BRAKE WEAR**

R MSN 0002-0860

Carbon brake wear depends on the number of brake applications and on brake temperature. It does not depend on the applied pressure, or the duration of the braking. The temperature at which maximum brake wear occurs depends on the brake manufacturer. Therefore, the only way the pilot can minimize brake wear is to reduce the number of brake applications.

**TAXI SPEED AND BRAKING**

R MSN 0002-0860

On long, straight taxiways, and with no ATC or other ground traffic constraints, the PF should allow the aircraft to accelerate to 30 knots, and should then use one smooth brake application to decelerate to 10 knots. The PF should not "ride" the brakes. The GS indication on the ND should be used to assess taxi speed.

R MSN 0002-0860

	<b>NORMAL OPERATIONS</b>  TAXI	02.040
		JAN 09/07

**BRAKE TEMPERATURE**

The FCOM limits brake temperature to 300 Deg C. before takeoff is started.

This limit ensures that, in the case of hydraulic fluid leakage, any hydraulic fluid, that may come into contact with the brake units, will not be ignited in the wheelwell.

This limit does not ensure that, in the case of a high energy rejected takeoff, the maximum brake energy limitation will be respected.

Thermal oxidation increases at high temperatures. Therefore, if the brakes absorb too much heat, carbon oxidation will increase. This is the reason why the brakes should not be used repeatedly at temperatures above 500 Deg. C. during normal operation. In addition, after heavy braking, the use of brake fans can increase oxidation of the brake surface hot spots, if the brakes are not thermally equalized.

**BRAKING ANOMALIES**

R MSN 0002-0860

If the ACCU PRESS drops below 1 500 PSI, the flight crew should be aware that the Parking Brake can, quite suddenly, become less efficient. This explains the amber range on the hydraulic pressure gauge of the ACCU PRESS.

If the flight crew encounters any braking problems during taxi, they should set the A/SKID & N/W STRG Sw to OFF. They should not apply pressure to the pedals while setting the A/SKID & N/W STRG Sw to OFF. Then, the PF should refer to the triple brake indicator and modulate the pressure as necessary.

**BRAKE FANS**

R MSN 0004-0012 0014 0017-0053 0056-0057 0059-0113 0115-0163 0165-0213 0215-0224 0226-0860

	<b>NORMAL OPERATIONS</b>  TAXI	02.040
		JAN 09/07

Brake fans cool the brakes, and the brake temperature sensor. Therefore, when the brake fans are running, the indicated brake temperature will be significantly lower than the indicated brake temperature when the brake fans are off.

Therefore, as soon as the brake fans are switched on, the indicated brake temperature decreases almost instantaneously. On the other hand, when the brake fans are switched off, it will take several minutes for the indicated brake temperature to increase and match the real brake temperature.

When the fans are running, the difference between the indicated and the actual brake temperature can range from 50 Deg. C. (when the actual brake temperature is 100 Deg. C) to 150 Deg. C. (when the actual brake temperature is 300 Deg. C). Therefore, before takeoff, if the fans are running, the flight crew should refer to the indicated brake temperature. When the indicated brake temperature is above 150 °C, takeoff must be delayed.

Brake fans should not be used during takeoff, in order to avoid Foreign Object Damage to fans and brakes.

<b>FLIGHT CONTROL CHECK</b>
-----------------------------

R MSN 0002-0860

At a convenient stage, before or during taxi, and before arming the autobrake, the PF silently applies full longitudinal and lateral sidestick deflection. On the F/CTL page, the PNF checks and calls out full travel of elevators and ailerons, and correct deflection and retraction of spoilers. As each full travel/neutral position is reached, the PNF calls out:

- . "Full up, full down, neutral"
- . "Full left, full right, neutral"

The PF silently checks that the PNF calls are in accordance with the sidestick order. The PF then presses the PEDAL DISC pb on the nosewheel tiller, and silently applies full left and full right rudder, and then returns the rudder to neutral. The PNF follows on the rudder pedals and, when each full travel/neutral position is reached, calls out:

- . "Full left, full right, neutral"

Full control input must be held for sufficient time for full travel to be reached and indicated on the F/CTL page.

	<b>NORMAL OPERATIONS</b>  TAXI	02.040
		JAN 09/07

The PNF then applies full longitudinal and lateral sidestick deflection, and on the F/CTL page, silently checks full travel and correct sense of all elevators and ailerons, and correct deflection and retraction of all spoilers.

If this check is carried out during taxi, it is essential that the PF remains head-up throughout the procedure.

### TAKEOFF BRIEFING CONFIRMATION

R MSN 0002-0860

Takeoff briefing should usually be a brief confirmation of the full takeoff briefing made at the parking bay and should include any changes that may have occurred, e.g. change of SID, change in runway conditions etc.

If ATC clears the aircraft to maintain a specific heading after takeoff, turn the FCU HDG selector to disarm the NAV. The current aircraft heading will be displayed on the FCU and the ND, and the flight crew can then set the cleared heading. Once airborne, and above 30 feet, RA, RWY TRK engages. To follow clearance, the FCU HDG knob should be pulled. Once cleared to resume the SID, a HDG adjustment may be necessary to intercept the desired track for NAV capture.

### TAXI WITH ONE ENGINE SHUTDOWN

	<b>NORMAL OPERATIONS</b>  TAXI	02.040
		JAN 09/07

R MSN 0012 0017 0030 0037 0045 0050 0054-0055 0059-0060 0062 0064-0073 0077  
0082-0083 0086-0087 0095-0096 0098-0100 0102 0106-0113 0116 0118-0122 0127 0132 0138  
0140 0143-0144 0148 0153 0155 0162 0165 0171-0172 0177 0181 0183-0184 0188-0189  
0191 0195 0198 0200 0203 0205-0206 0209 0211 0219 0222-0224 0226 0229-0232 0234  
0238 0240-0241 0244 0247-0251 0253-0256 0258-0259 0261-0262 0265-0267 0269 0271-0272  
0275-0277 0279 0281 0283-0291 0293-0296 0299-0301 0303 0305-0306 0308-0309 0311-0317  
0320 0322-0324 0326 0328 0330 0333-0334 0337-0346 0348-0351 0353 0356-0358 0361-0362  
0364-0366 0368-0370 0372 0375 0380 0382 0384 0386 0388-0389 0392-0393 0396-0398  
0400-0401 0403-0405 0407-0409 0412 0418-0423 0425 0427-0428 0432 0437 0439 0441  
0443-0444 0448 0451-0452 0454-0456 0458 0461-0463 0465-0466 0469 0472-0473 0476-0477  
0479-0481 0484 0486-0487 0489-0491 0493-0494 0496-0498 0500-0513 0515-0516 0518-0519  
0521-0522 0524-0527 0529-0530 0532-0533 0535-0536 0539 0542 0548-0553 0555 0558  
0564-0565 0567-0568 0570-0571 0573-0574 0576 0578-0579 0581 0584 0587-0588 0591-0597  
0600 0602-0603 0605 0607 0609-0610 0612-0614 0616 0618 0620-0621 0623 0625 0627  
0629 0631-0638 0640-0642 0644-0645 0647-0650 0652-0667 0669-0671 0673-0676 0678-0680  
0682-0684 0686-0688 0690-0693 0695-0697 0699-0701 0703-0705 0707-0709 0711-0714  
0716-0718 0720-0722 0724-0726 0728-0730 0732-0735 0737-0739 0741-0743 0745-0747  
0749-0752 0754-0756 0758-0760 0769-0770 0772-0774 0776-0778 0780-0782 0784-0786  
0788-0789 0791-0792 0795-0797 0799 0801-0803 0805-0811 0813-0828 0830-0834 0836  
0838-0843 0845 0847 0849-0860

Brake life and fuel savings may govern company policy on permitting aircraft to taxi with one engine shut down. However, if taxiing out with one engine shutdown, the flight crew should be aware of the following:

- . It is recommended to retain the use of Engine 1 during taxi to maintain the accumulator pressure of the blue hydraulic system.
- . If taxi is performed with Engine 2, the flight crew should check the accumulator pressure of the blue hydraulic system.
- . Slow or tight turns in the direction of the operating engine may not be possible at high Gross Weights.
- . It is not possible for ground personnel to protect the engine against fire, when the aircraft moves away from the ramp.
- . The remaining engines should be started with sufficient time for engine warm-up before takeoff
- . Any faults encountered during, or after, starting the remaining engine may require a return to the gate for maintenance. This could result in an additional departure delay.
- . Taxi with one engine shut down may require higher thrust than usual. Caution must, therefore, be exercised to avoid excessive jet-blast and the risk of Foreign Object Damage (FOD).
- . It is recommended that the flight crew use the APU. However, APU bleed should be switched off, in order to avoid ingestion of exhaust gases by the air conditioning system.



	<b>NORMAL OPERATIONS</b>  TAXI	02.040
		JAN 09/07

**TAXI WITH TWO ENGINES SHUTDOWN**

R MSN 0002-0011 0013-0016 0018-0029 0031-0035 0038-0044 0046-0049 0051-0053 0056-0058  
0061 0063 0074-0076 0078-0081 0084-0085 0088-0094 0097 0101 0103-0104 0114-0115 0117  
0123-0126 0128-0131 0133-0137 0139 0141-0142 0145-0147 0149-0152 0154 0156-0161  
0163-0164 0166-0170 0173-0176 0178-0180 0182 0185-0187 0190 0192-0194 0196-0197 0199  
0201-0202 0204 0207-0208 0210 0212-0218 0220-0221 0225 0227-0228 0233 0235-0237  
0239 0242-0243 0245-0246 0252 0257 0260 0263-0264 0268 0270 0273-0274 0278 0280  
0282 0292 0297 0302 0304 0307 0310 0318-0319 0321 0325 0327 0329 0331-0332  
0335 0347 0352 0354-0355 0359 0363 0367 0371 0373-0374 0376-0379 0381 0383 0385  
0387 0390-0391 0394-0395 0399 0402 0406 0410-0411 0413-0417 0424 0426 0429-0431  
0433-0436 0438 0440 0442 0445-0447 0449-0450 0453 0457 0459-0460 0464 0467-0468  
0470-0471 0474-0475 0478 0482-0483 0485 0488 0492 0495 0499 0514 0517 0520 0523  
0528 0531 0534 0537-0538 0540-0541 0543-0547 0554 0556-0557 0559-0563 0566 0569  
0572 0575 0577 0580 0582-0583 0585-0586 0590 0598 0601 0604 0606 0608 0611 0615  
0617 0619 0622 0624 0626 0628 0630 0639 0643 0646 0651 0668 0672 0677 0681 0685  
0689 0694 0698 0702 0706 0710 0715 0719 0723 0727 0731 0736 0740 0744 0748 0753  
0757 0761-0768 0771 0775 0779 0783 0787 0790 0793-0794 0798 0800 0804 0812 0829  
0835 0837 0844 0846 0848

R (1)

Brake life and fuel savings may govern company policy on permitting aircraft to taxi with engines shut down. However, if taxiing out with two engines shut down, the flight crew should be aware of the following:

- . It is recommended to retain the use of Engines 1 and 4 during taxi to maintain the green hydraulic system for normal braking and NWS.
- . Operational reasons may require taxiing on inner engines (e.g. narrow taxiways where unpaved sideways may increase the FOD risk). The inner engines do not pressurize the green hydraulic system. Therefore, the flight crew should set the green electrical pump to ON. The hydraulic power delivered by the green electrical pump is limited, and therefore the flight crew must not extend/retract flaps/slats during taxi.
- . It is not possible for ground personnel to protect the engine against fire, when the aircraft moves away from the ramp.
- . The remaining engines should be started with sufficient time for engine warm-up before takeoff.
- . Any faults encountered during, or after, starting the remaining engine may require a return to the gate for maintenance. This could result in an additional departure delay.

	<b>NORMAL OPERATIONS</b>	02.040
	TAXI	JAN 09/07

- . Taxi with two engines shut down may require higher thrust than usual. Caution must, therefore, be exercised to avoid excessive jet-blast and the risk of Foreign Object Damage (FOD).
- . It is recommended that the flight crew use the APU. However, APU bleed should be switched off, in order to avoid ingestion of exhaust gases by the air conditioning system.

<b>MISCELLANEOUS</b>
----------------------

R MSN 0002-0860

### **STROBE LIGHT**

When the STROBE lights are set to AUTO, they come on automatically when the aircraft is airborne. The ON position can be used to turn on the lights on ground for crossing, backtracking or entering a runway.

### **PACKS**

If takeoff must be completed without air bleed from the engines (for performance reasons), but air conditioning is desired, then APU bleed may be used with the packs set to ON. This will maintain the engine performance level, and passenger comfort. In the event of an APU auto-shutdown during takeoff, engine thrust is frozen until the thrust is manually-reduced. The packs revert to engine bleed that causes an increase of EGT, in order to maintain N1/EPR.

If the take-off is performed with one pack unserviceable, the procedure states to set the failed pack to OFF. The take-off may be performed with the other pack ON (if performances permit) with TOGA or FLEX thrust, the pack being supplied by the outside bleed. In this asymmetric bleed configuration, the N1 take-off value is limited to the value corresponding to the bleed ON configuration and take-off performances must be computed accordingly.

### **IN SEAT POWER SUPPLY SYSTEM (ISPSS)**

When installed, the In Seat Power Supply System (ISPSS) provides electrical power to the In Seat Power Supply Unit (ISPSU) outlets. These outlets enable passengers to use Portable Electronic Devices (PEDs). The ISPSS must be turned off during takeoff and landing.

**BEFORE TAKEOFF FLOW PATTERN**

R MSN 0002-0860

BEFORE TAKEOFF FLOW PATTERN

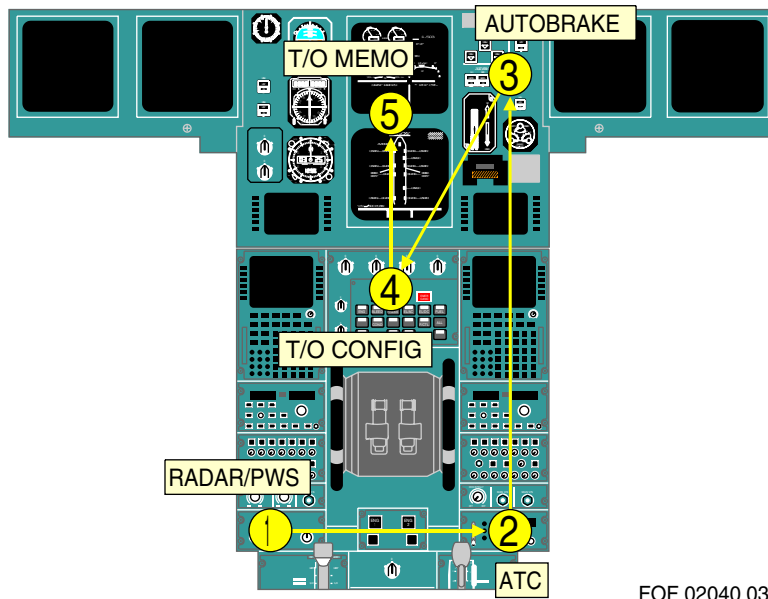

FOF 02040 03887 0001

	NORMAL OPERATIONS TAXI	02.040
		JAN 09/07

**HIGHLIGHTS**

- (1) Correction of printing error

**THRUST SETTING**

R MSN 0002-0011 0013-0016 0018-0070 0072-0082 0084-0097 0100-0101 0103-0104 0107  
0110 0112 0114-0117 0119-0120 0122-0131 0133-0137 0139 0141-0143 0145-0147 0149-0152  
0154 0156-0164 0166-0176 0178-0233 0235-0243 0245-0247 0249 0252-0253 0255-0260  
0262-0264 0267-0270 0272-0275 0278 0280 0282 0288-0292 0294 0296-0300 0302 0304-0305  
0307-0308 0310 0312 0315 0317-0319 0321-0325 0327 0329-0333 0335-0339 0342-0343  
0346-0347 0350-0355 0358-0364 0366-0368 0370 0373-0375 0377-0381 0385 0387-0388 0390  
0395 0397 0399 0402-0403 0406 0411 0413-0415 0422 0424-0425 0428-0430 0432-0435  
0438 0441-0444 0446-0448 0450 0454 0458-0459 0463 0465-0467 0469-0470 0472-0474  
0476-0477 0481 0483-0484 0486-0487 0489-0490 0493 0498 0500 0502-0504 0506-0508  
0510-0511 0513 0516 0519 0521-0522 0524 0528 0530 0533 0535 0538 0541-0542 0544-0546  
0549-0550 0552-0556 0558-0559 0561-0562 0564 0567 0571 0573-0574 0578 0582 0584-0585  
0587-0595 0598 0602-0603 0605 0607 0609 0612-0614 0616 0618 0620-0621 0623 0631  
0633-0634 0637-0638 0640-0641 0643-0644 0646-0647 0650-0651 0653 0655 0657 0659-0661  
0663 0665 0667-0668 0671 0674-0676 0678 0680 0682 0684 0686 0690-0691 0693 0695  
0697 0699-0700 0703-0705 0707-0708 0711-0712 0714 0718 0721-0722 0725 0733-0734  
0738-0739 0742-0743 0745-0747 0749 0752 0754-0755 0758 0760 0769-0770 0772 0774  
0778 0784 0789 0792-0793 0796 0799-0803 0805-0806 0811 0813-0814 0817 0819-0820  
0822-0823 0825-0828 0831 0834-0835 0838 0841-0845 0847 0849 0853 0857-0859

The PF should announce "TAKE-OFF". The PF then applies power in as follows:

If cross wind is at or below 20 kts and there is no tail wind:

- . From idle to 1.1EPR / 50% N1 by reference to the TLA indicator on the EPR / N1 gauge.
- . When the engine parameters have stabilized, to the FLX/MCT or TOGA detent as appropriate.

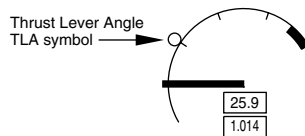

FOF 02050 03853 0001

In case of tailwind or if cross wind is greater than 20 kts:

- From idle to 1.1 EPR / 50% N1 by reference to the TLA indicator on the EPR / N1 gauge.
- Once stabilized, from 1.1 EPR / 50 % N1 to 1.3 EPR / 70% N1 by reference to the TLA indicator on the EPR / N1 gauge.
- Then, to FLX / TOGA, as required to reach take-off thrust by 40 kts groundspeed.

This procedure ensures that all engines will accelerate similarly. If not properly applied, this may lead to asymmetrical thrust increase, and, consequently, to severe directional control problem.

	<b>NORMAL OPERATIONS</b>  TAKEOFF	02.050
		JAN 09/07

If the thrust levers are not set to the proper take-off detent, e.g. FLX instead of TOGA, a message comes up on the ECAM.

R MSN 0012 0017 0071 0083 0098-0099 0102 0106 0109 0111 0113 0118 0121 0132 0138  
 0140 0144 0148 0153 0155 0165 0177 0234 0244 0248 0250-0251 0254 0261 0265-0266  
 0271 0276-0277 0279 0281 0283-0287 0293 0295 0301 0303 0306 0309 0311 0313-0314  
 0316 0320 0326 0328 0334 0340 0344-0345 0348-0349 0356-0357 0365 0369 0372 0382  
 0384 0386 0389 0392-0393 0396 0398 0400-0401 0404-0405 0407-0409 0412 0418-0421 0423  
 0427 0437 0439 0451-0452 0455-0456 0461-0462 0479-0480 0491 0494 0496-0497 0501  
 0505 0509 0512 0515 0518 0525-0527 0529 0532 0536 0539 0548 0551 0565 0568 0570  
 0576 0579 0581 0597 0600 0610 0625 0627 0629 0632 0635-0636 0642 0645 0648-0649  
 0652 0654 0656 0658 0662 0664 0666 0669-0670 0673 0679 0683 0687-0688 0692 0696  
 0701 0709 0713 0716-0717 0720 0724 0726 0728-0730 0732 0735 0737 0741 0750-0751  
 0756 0759 0773 0776-0777 0780-0782 0785-0786 0788 0791 0795 0797 0807-0810 0815  
 0818 0821 0824 0830 0832-0833 0836 0839-0840 0850-0852 0854-0855 0860

A fan stall protection within the FADEC adjusts the EPR acceleration rate at low speed. This avoids having high N1 at low speed. As a consequence, the power set at take-off is slightly longer than on others engines (approximately 10 seconds more) and the take-off thrust is reached at around IAS 60 kts. For this reason, thrust can be set in one step regardless of wind conditions. However, for commonality reason, the thrust should be set in two steps in all cases except in case of crosswind conditions where this must be done in one step.

The PF should announce Take-off". The PF then applies power in as follows:

If cross wind is at or below 20 kts and there is no tail wind:

- From idle to 1.1EPR / 50% N1 to the TLA indicator on the EPR / N1 gauge.
- When the engine parameters have stabilised, to the FLX/MCT or TOGA detent as appropriate.

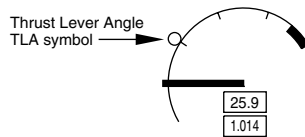

FOF 02050 03853 0001

In case of tailwind or if cross wind is greater than 20 kts:

- . From idle on both engines to FLX or TOGA

This procedure ensures that all engines will accelerate similarly. If not properly applied, this may lead to asymmetrical thrust increase, and, consequently, to severe directional control problem.

If the thrust levers are not set to the proper take-off detent, e.g. FLX instead of TOGA, a message comes up on the ECAM.

R MSN 0371 0376 0383 0391 0394 0410 0416-0417 0426 0431 0436 0440 0445 0449 0453  
 0457 0460 0464 0468 0471 0475 0478 0482 0485 0488 0492 0495 0499 0514 0517 0520  
 0523 0531 0534 0537 0540 0543 0547 0557 0560 0563 0566 0569 0572 0575 0577 0580  
 0583 0586 0601 0604 0606 0608 0611 0615 0617 0619 0622 0624 0626 0628 0630 0639  
 0672 0677 0681 0685 0689 0694 0698 0702 0706 0710 0715 0719 0723 0727 0731 0736  
 0740 0744 0748 0753 0757 0761-0768 0771 0775 0779 0783 0787 0790 0794 0798 0804  
 0812 0829 0837 0846 0848

The PF should announce Take-off". The PF then applies power in as follows:

If crosswind is at or below 20 kts and there is no tail wind:

- . From idle to 1.05 EPR by reference to the TLA indicator on the EPR gauge.
- . When the engine parameters have stabilized, to the FLX/MCT or TOGA detent as appropriate.

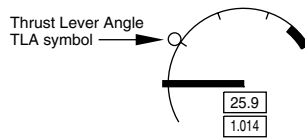

FOF 02050 03853 0001

In case of tailwind or if crosswind is greater than 20 kts:

- From idle to 1.05 EPR in a rapid setting.
- Once stabilized, from 1.05 EPR to CL thrust by 20 kts ground speed
- Then, to FLX / TOGA, as required to reach take-off thrust by 40 kts groundspeed.

This procedure ensures that all engines will accelerate similarly. If not properly applied, this may lead to asymmetrical thrust increase, and, consequently, to severe directional control problem.

If the thrust levers are not set to the proper take-off detent, e.g. FLX instead of TOGA, a message comes up on the ECAM

### TAKE-OFF ROLL

R MSN 0002-0860

Once the thrust is set, the PF announces the indications on the FMA. The PNF must check that the thrust is set by 80 kts and must announce Power Set".

	<b>NORMAL OPERATIONS</b>  TAKEOFF	02.050
		JAN 09/07

The Captain must keep his hand on the thrust levers when the thrust levers are set to TOGA/FLX notch and until V1.

On a normal take-off, to counteract the pitch up moment during thrust application, the PF should apply half forward (full forward in cross wind case) sidestick at the start of the take-off roll until reaching 80 kts. At this point, the input should be gradually reduced to be zero by 100 kts.

The PF should use pedals to keep the aircraft straight. The nosewheel steering will be effective until reaching 100 kts but its authority decreases at a pre-determined rate as the groundspeed increases and the rudder becomes more effective. The use of the tiller is not recommended during takeoff roll, because of its high efficiency, which might lead to aircraft overreaction.

For crosswind takeoffs, routine use of into wind aileron is not necessary. In strong crosswind conditions, small lateral stick input may be used, if deemed necessary due to into wind wing reaction, but avoid using large deflections, resulting in excessive spoiler deployment which increase the aircraft tendency to turn into the wind (due to high weight on wheels on the spoiler extended side), reduces lift and increases drag. Spoiler deflection becomes significant with more than half sidestick deflection.

As the aircraft lifts off, any lateral stick input applied will result in a roll rate demand, making aircraft lateral control more difficult. Wings must be level.

In case of low visibility take-off, visual cues are primary means to track the runway centerline. The PFD yaw bar provides an assistance in case of expected fog patches if ILS available.

**TYPICAL AIRCRAFT ATTITUDE AT TAKEOFF AFTER LIFT-OFF**

R MSN 0012 0017 0030 0037 0045 0050 0054-0055 0059-0060 0062 0064-0073 0077  
 0082-0083 0086-0087 0095-0096 0098-0100 0102 0106-0113 0116 0118-0122 0127 0132 0138  
 0140 0143-0144 0148 0153 0155 0162 0165 0171-0172 0177 0181 0183-0184 0188-0189  
 0191 0195 0198 0200 0203 0205-0206 0209 0211 0219 0222-0224 0226 0229-0232 0234  
 0238 0240-0241 0244 0247-0251 0253-0256 0258-0259 0261-0262 0265-0267 0269 0271-0272  
 0275-0277 0279 0281 0283-0291 0293-0296 0299-0301 0303 0305-0306 0308-0309 0311-0317  
 0320 0322-0324 0326 0328 0330 0333-0334 0337-0346 0348-0351 0353 0356-0358 0361-0362  
 0364-0366 0368-0372 0375-0376 0380 0382-0384 0386 0388-0389 0391-0394 0396-0398  
 0400-0401 0403-0405 0407-0410 0412 0416-0423 0425-0428 0431-0432 0436-0437 0439-0441  
 0443-0445 0448-0449 0451-0458 0460-0466 0468-0469 0471-0473 0475-0482 0484-0527  
 0529-0537 0539-0540 0542-0543 0547-0553 0555 0557-0558 0560 0563-0581 0583-0584  
 0586-0588 0591-0597 0600-0642 0644-0645 0647-0650 0652-0667 0669-0792 0794-0799  
 0801-0834 0836-0843 0845-0860



	<b>NORMAL OPERATIONS</b>  TAKEOFF	02.050
		JAN 09/07

At take off, the typical all engine operating attitude after lift-off is about 15°.

R MSN 0002-0011 0013-0016 0018-0029 0031-0035 0038-0044 0046-0049 0051-0053 0056-0058  
 0061 0063 0074-0076 0078-0081 0084-0085 0088-0094 0097 0101 0103-0104 0114-0115 0117  
 0123-0126 0128-0131 0133-0137 0139 0141-0142 0145-0147 0149-0152 0154 0156-0161  
 0163-0164 0166-0170 0173-0176 0178-0180 0182 0185-0187 0190 0192-0194 0196-0197 0199  
 0201-0202 0204 0207-0208 0210 0212-0218 0220-0221 0225 0227-0228 0233 0235-0237  
 0239 0242-0243 0245-0246 0252 0257 0260 0263-0264 0268 0270 0273-0274 0278 0280  
 0282 0292 0297 0302 0304 0307 0310 0318-0319 0321 0325 0327 0329 0331-0332 0335  
 0347 0352 0354-0355 0359 0363 0367 0373-0374 0377-0379 0381 0385 0387 0390 0395  
 0399 0402 0406 0411 0413-0415 0424 0429-0430 0433-0435 0438 0442 0446-0447 0450  
 0459 0467 0470 0474 0483 0528 0538 0541 0544-0546 0554 0556 0559 0561-0562 0582  
 0585 0590 0598 0643 0646 0651 0668 0793 0800 0835 0844

At takeoff, the typical all engine operating attitude after lift-off is about 12.5°.

**ROTATION**

R MSN 0002-0860

**INITIAL STICK INPUT CALIBRATION IN TRAINING**

In training, during taxi, the crew may calibrate the appropriate effort and displacement for the initial stick input for rotation (2/3 back-stick), by pulling aft on the stick and observing the position of the stick cross symbol on the PFD, compared to the stick position reference square.

**SIDE STICK INPUT CALIBRATION DURING TAXI**

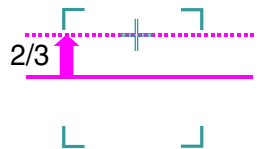

FOF 02050 03857 0001

*Note: the cross is not to be used by PF during the takeoff, whereas the PNF can check the validity of the PF initial stick input.*

**ROTATION TECHNIQUE**

Rotation is conventional. During the takeoff roll and the rotation, the pilot flying scans rapidly the outside visual reference and the PFD. Until airborne, or at least until visual cues are lost, this scanning depends on visibility conditions (the better the visibility, the higher the priority given to outside visual references). Once airborne, the PF then controls the pitch attitude on the PFD using FD bars in SRS mode which is then valid.

The higher the inertia of the aircraft is, the more it is important to initiate the rotation with a smooth positive backward sidestick input (typically 2/3 backstick). Avoid aggressive and sharp inputs.

The initial rotation rate takes time to establish. For a given sidestick input, once it has developed, it remains relatively constant. It is typically between 2 and 3 °/sec.

If the established pitch rate is not satisfactory, the pilot must make smooth corrections on the stick. He must avoid rapid and large corrections, which cause sharp reaction in pitch from the aircraft. If, to increase the rotation rate, a further and late aft sidestick input is made around the time of lift-off, the possibility of tailstrike increases significantly.

During rotation, the crew must not chase the FD pitch bar, since it does not give any pitch rate order, and might lead to overreaction.

Once airborne only, the crew must refine the aircraft pitch attitude using the FD, which is then representative of the SRS orders. The fly-by-wire control laws change into flight normal law, with automatic pitch trim active.

**LONG AIRCRAFT SPECIFICITY**

R MSN 0371 0376 0383 0391 0394 0410 0416-0417 0426 0431 0436 0440 0445 0449 0453  
 0457 0460 0464 0468 0471 0475 0478 0482 0485 0488 0492 0495 0499 0514 0517 0520  
 0523 0531 0534 0537 0540 0543 0547 0557 0560 0563 0566 0569 0572 0575 0577 0580  
 0583 0586 0601 0604 0606 0608 0611 0615 0617 0619 0622 0624 0626 0628 0630 0639  
 0672 0677 0681 0685 0689 0694 0698 0702 0706 0710 0715 0719 0723 0727 0731 0736  
 0740 0744 0748 0753 0757 0761-0768 0771 0775 0779 0783 0787 0790 0794 0798 0804  
 0812 0829 0837 0846 0848

Compared to shorter aircraft, the sensory feedback to the pilot during the rotation is different due to the length of the aircraft and its flexibility:

- Since the aircraft is longer, for a same rotation rate, the local vertical acceleration sensed by the pilot is higher.

VERTICAL ACCELERATION SENSING (1)

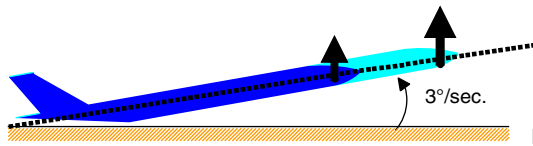

FOF 02050 03864 0001

This effect is increased by the flexibility of the aircraft. The pilot senses first (1), a delay in the rotation. Then (2), the sensory effects of the local vertical acceleration are somehow amplified.

VERTICAL ACCELERATION SENSING (2)

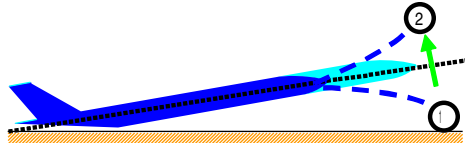

FOF 02050 03865 0001

This sensory feedback shall not lead the pilot to overact by making large changes in the sidestick inputs, which lead to potential large pitch oscillations. Be smooth on the stick.

With respect to the rotation law of A330/ A340-300/-200, the A340-500/600, flight control laws have been adapted to take into account the different characteristics of the aircraft, such as longer fuselage. Additionally, rotation rate and tail-clearance are monitored, and if tail-clearance becomes marginal the rotation rate is automatically reduced until lift-off.

A pitch limit indication is provided on the PFD at takeoff. It is displayed from the power application up to 3 seconds after lift off.

R MSN 0181 0195 0205 0211 0222-0223 0226 0229-0230 0232 0238 0240 0247-0251  
0253-0255 0258-0259 0261-0262 0265-0266 0269 0271-0272 0275-0276 0281 0283 0285-0291  
0293-0296 0299-0301 0303 0305-0306 0308-0309 0311-0314 0316-0317 0320 0322 0324  
0326 0328 0330 0334 0339-0340 0343 0345 0348 0353 0358 0361-0362 0364-0366 0369  
0372 0382 0384 0392 0396-0398 0401 0403-0404 0409 0422 0427 0432 0437 0441  
0443-0444 0448 0451-0452 0454-0456 0458 0461-0463 0465-0466 0469 0472-0473 0476-0477  
0480-0481 0486-0487 0489 0491 0493-0494 0498 0500-0511 0513 0516 0518-0519 0521-0522  
0525-0527 0529-0530 0532 0535-0536 0551 0555 0567 0571 0573 0584 0587 0597 0600  
0605 0609-0610 0612-0614 0616 0618 0620-0621 0625 0627 0631-0635 0638 0644 0647  
0649-0650 0652-0653 0655-0658 0660-0661 0664-0667 0678 0682-0684 0686 0688 0693  
0696-0697 0700 0703-0704 0709 0717-0718 0722 0724 0726 0728-0730 0732-0733 0735  
0737-0739 0742-0743 0745-0747 0749-0751 0754-0756 0759-0760 0770 0774 0778 0780  
0785 0788 0792 0795-0797 0801-0802 0807-0811 0814-0815 0818-0822 0824-0825 0828  
0831-0832 0834 0839-0842 0849 0852-0854 0860

**AIRCRAFT GEOMETRY**

MAX PITCH ATTITUDE ON GROUND depending on main gear oleo position	
fully extended	fully compressed
16.0 °	11.5 °

R MSN 0030 0037 0045 0054-0055 0059 0070 0086 0183-0184 0188-0189 0191 0198 0200 0203 0553 0558 0564 0574 0593-0595 0602-0603 0607 0623 0637 0641 0659 0671 0675 0680 0691 0695 0699 0705 0707 0711-0712 0714 0721 0725 0734 0752 0769 0789 0805 0813 0823 0826 0838 0847

**AIRCRAFT GEOMETRY**

MAX PITCH ATTITUDE ON GROUND depending on main gear oleo position	
fully extended	fully compressed
14.2 °	10.1 °

R MSN 0012 0017 0050 0060 0062 0064-0069 0071-0073 0077 0082-0083 0087 0095-0096 0098-0100 0102 0106-0113 0116 0118-0122 0127 0132 0138 0140 0143-0144 0148 0153 0155 0162 0165 0171-0172 0177 0206 0209 0219 0224 0231 0234 0241 0244 0256 0267 0277 0279 0284 0315 0323 0333 0337-0338 0342 0344 0346 0349-0351 0356-0357 0368 0370 0375 0380 0386 0388-0389 0393 0400 0405 0407-0408 0412 0418-0421 0423 0425 0428 0439 0479 0484 0490 0496-0497 0512 0515 0524 0533 0539 0542 0548-0550 0552 0565 0568 0570 0576 0578-0579 0581 0588 0591 0629 0636 0640 0642 0645 0648 0654 0662-0663 0669-0670 0673-0674 0676 0679 0687 0690 0692 0701 0708 0713 0716 0720 0741 0758 0772-0773 0776-0777 0781-0782 0784 0786 0791 0799 0803 0806 0817 0827 0830 0833 0836 0843 0845 0850-0851 0855-0859

**AIRCRAFT GEOMETRY**

MAX PITCH ATTITUDE ON GROUND depending on main gear oleo position	
fully extended	fully compressed
14.4 °	10.1 °

	<b>NORMAL OPERATIONS</b>  TAKEOFF	02.050
		JAN 09/07

MSN 0004 0006 0008-0011 0014 0018-0019 0021-0022 0026 0031 0038 0043 0046 0061  
0063 0074-0075 0080-0081 0085 0151 0156 0159 0178 0204

**AIRCRAFT GEOMETRY**

MAX PITCH ATTITUDE ON GROUND depending on main gear oleo position	
fully extended	fully compressed
15.8 °	11.3 °

R MSN 0002-0003 0005 0007 0013 0015-0016 0020 0023-0025 0027-0029 0032-0035 0039-0041  
0044 0047-0049 0051-0053 0056-0058 0076 0078-0079 0084 0088-0094 0097 0101 0103-0104  
0114-0115 0117 0123-0126 0128-0131 0133-0137 0139 0141-0142 0145-0147 0149-0150 0152  
0154 0157-0158 0160-0161 0163-0164 0166-0170 0173-0176 0179-0180 0182 0185-0187  
0190 0192-0194 0196-0197 0199 0201-0202 0207-0208 0210 0212-0218 0220-0221 0225  
0227-0228 0233 0235-0237 0239 0242-0243 0245-0246 0252 0257 0260 0263-0264 0268  
0270 0273-0274 0278 0280 0282 0292 0297 0302 0304 0307 0310 0318-0319 0321 0325  
0327 0329 0331-0332 0335 0347 0352 0354-0355 0359 0363 0367 0373-0374 0377-0379  
0381 0385 0387 0390 0395 0399 0402 0406 0411 0413-0415 0424 0429-0430 0433-0435  
0438 0442 0446-0447 0450 0459 0467 0470 0474 0483 0528 0538 0541 0544-0546 0554  
0556 0559 0561-0562 0582 0585 0590 0598 0643 0646 0651 0668 0793 0800 0835 0844

**AIRCRAFT GEOMETRY**

MAX PITCH ATTITUDE ON GROUND depending on main gear oleo position	
fully extended	fully compressed
14.2 °	10.1 °

R MSN 0394 0445 0457 0464 0471 0478 0485 0492 0495 0499 0520 0560 0563 0572 0608  
0611 0624 0628 0685 0694 0698 0748 0757 0761 0775 0783

	<b>NORMAL OPERATIONS</b>	02.050
	TAKEOFF	JAN 09/07

**AIRCRAFT GEOMETRY**

MAX PITCH ATTITUDE ON GROUND depending on main gear oleo position	
fully extended	fully compressed
13.5 °	9.5 °

R MSN 0371 0376 0383 0391 0410 0416-0417 0426 0431 0436 0440 0449 0453 0460 0468 0475 0482 0488 0514 0517 0523 0531 0534 0537 0540 0543 0547 0557 0566 0569 0575 0577 0580 0583 0586 0601 0604 0606 0615 0617 0619 0622 0626 0630 0639 0672 0677 0681 0689 0702 0706 0710 0715 0719 0723 0727 0731 0736 0740 0744 0753 0762-0768 0771 0779 0787 0790 0794 0798 0804 0812 0829 0837 0846 0848

**AIRCRAFT GEOMETRY**

MAX PITCH ATTITUDE ON GROUND depending on main gear oleo position	
fully extended	fully compressed
12 °	8.5 °

**TAIL STRIKE AVOIDANCE**

R MSN 0002-0860

**INTRODUCTION**

Tail strikes can cause extensive structural damage, which can jeopardize the flight and lead to heavy maintenance action. They most often occur in such adverse conditions as crosswind, turbulence, windshear, etc.

The minimum tail clearance occurs before lift off (due to rotating bogies).

**MAIN FACTORS**

**EARLY ROTATION**

	<b>NORMAL OPERATIONS</b>	02.050
	<b>TAKEOFF</b>	JAN 09/07

Early rotation occurs when rotation is initiated below the scheduled VR. The potential reasons for this are:

- . The calculated VR is incorrect for the aircraft weight or flap configuration.
- . The PF commands rotation below VR due to gusts, windshear or an obstacle on the runway.

Whatever the cause of the early rotation, the result will be an increased pitch attitude at lift-off, and consequently a reduced tail clearance.

## ROTATION TECHNIQUE

The recommendation given in the ROTATION TECHNIQUE paragraph should be applied.

A fast rotation rate increases the risk of tailstrike, but a slow rate increases take-off distance. The recommended rate is between 2 and 3 degs/sec, which reflects the average rates achieved during flight test, and is also the reference rate for performance calculations.

## CONFIGURATION

When performance is limiting the takeoff weight, the flight crew uses TOGA thrust and selects the configuration that provides the highest takeoff weight.

When the actual takeoff weight is lower than the permissible one, the flight crew uses FLEX TO thrust. For a given aircraft weight, a variety of flap configurations are possible. Usually, the flight crew selects the configuration that provides the maximum FLEX temperature. This is done to prolong engine life.

### On A340-500/600:

For any runway length, CONF 3 usually provides the highest FLEX temperature, and the tail clearance at lift off does not depend on the configuration. So, the flight crew should select CONF 3.

### On A330 and A340-300:

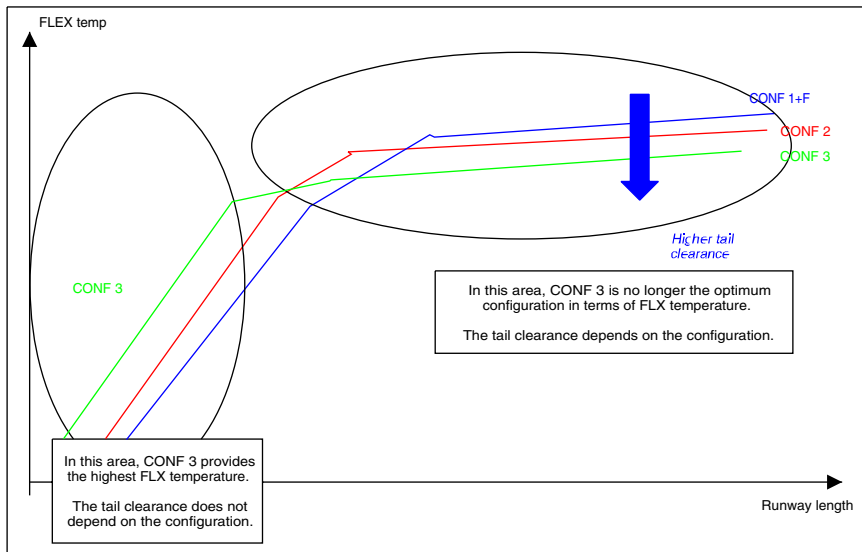

FOF 02050 00000 0001

The configuration that provides the maximum FLEX temperature varies with the runway length.

On short runways, CONF 3 usually provides the highest FLEX temperature, and the tail clearance at lift off does not depend on the configuration. So, the flight crew should select CONF 3.

On medium or long runways, the second segment limitation becomes the limiting factor, and CONF 2 or CONF 1+F becomes the optimum configuration, in terms of FLEX temperature. In these cases, the tail clearance at lift off depends on the configuration. The highest flap configuration gives the highest tailstrike margin.

There is a difference between twin and quadri, regarding this concern: The A330 has more tail clearance than the A340, that has quite often, takeoff speeds closer to VMU limitation. This is true with one engine inoperative. Since twin aircraft have more thrust margin for takeoff, this is even more the case with all engines operative.

On A340-300, selecting CONF 3 instead of 1+F increases the tail clearance by 1.5 to 2ft, at the expense of a loss in FLEX temperature generally less than 3 °C.

**Note:** *detailed effect:*

- From CONF 1+F to CONF 2: Tail clearance increased by 0.5 to 1 ft, loss in FLEX temperature generally less than 1 °C.



	<b>NORMAL OPERATIONS</b>  TAKEOFF	02.050
		JAN 09/07

- . From CONF 2 to CONF 3: Tail clearance increased by 1 ft, loss in FLEX temperature generally less than 2° C.

The first degrees of flexible thrust have an impact on maintenance costs about 5 times higher than the last one.

Summary:

On A340-200/300, taking the above into consideration, the crew may decide to select CONF 2 or CONF 3:

- . When the FLEX temperature is close to Tref, it is advisable to select one more step of flaps (compared to the optimum one).
- . When the FLEX temperature is more than 15 °C above Tref, it is advisable to select CONF 3.

**TAKEOFF TRIM SETTING**

The main purpose of the pitch trim setting for take-off is to provide consistent rotation characteristics. Takeoff pitch trim setting is automatic on ground on the 340-500/600 and A330/A340 Enhanced (with specific aircraft definition) and is set manually via the pitch trim wheel on other A330/340 models.

The aircraft performs a safe takeoff, provided the pitch trim setting is within the green band on the pitch trim wheel.

However, the pitch trim setting significantly affects the aircraft behaviour during rotation:

- . With a forward CG and the pitch trim set to the nose-down limit the pilots will feel an aircraft heavy to rotate" and aircraft rotation will be very slow in response to the normal take off stick displacement.
- . With an aft CG and the pitch trim set to the nose-up limit the pilots will most probably have to counteract an early autorotation until VR is reached.

In either case the pilot may have to modify his normal control input in order to achieve the desired rotation rate, but should be cautious not to overreact.

**CROSSWIND TAKEOFF**

It is said in the TAKEOFF ROLL paragraph that care should be taken to avoid using large deflection, resulting in excessive spoiler deployment.

A direct effect of the reduction in lift due to the extension of the spoilers on one wing will be a reduction in tail clearance and an increased risk of tailstrike.

**OLEO INFLATION**

	<b>NORMAL OPERATIONS</b>  <b>TAKEOFF</b>	02.050
		JAN 09/07

The correct extension of the main landing gear shock absorber (and thus the nominal increase in tail clearance during the rotation) relies on the correct inflation of the oleos. An under inflated oleo will delay the start of the bogie rotation and reduce tail clearances.

**ACTION IN CASE OF TAILSTRIKE**

If a tailstrike occurs at takeoff, flight at attitude requiring a pressurized cabin must be avoided and a return to the originating airport should be performed for damage assessment.

R MSN 0030 0037 0045 0050 0054-0055 0059-0060 0062 0064-0070 0072-0073 0077 0082  
0086-0087 0095-0096 0100 0107 0110 0112 0116 0119-0120 0122 0127 0143 0162  
0171-0172 0181 0183-0184 0188-0189 0191 0195 0198 0200 0203 0205-0206 0209 0211  
0219 0222-0224 0226 0229-0232 0238 0240-0241 0247 0249 0253 0255-0256 0258-0259  
0262 0267 0269 0272 0275 0288-0291 0294 0296 0299-0300 0305 0308 0312 0315 0317  
0322-0324 0330 0333 0337-0339 0342-0343 0346 0350-0351 0353 0358 0361-0362 0364  
0366 0368 0370 0375 0380 0388 0397 0403 0422 0425 0428 0432 0441 0443-0444 0448  
0454 0458 0463 0465-0466 0469 0472-0473 0476-0477 0481 0484 0486-0487 0489-0490  
0493 0498 0500 0502-0504 0506-0508 0510-0511 0513 0516 0519 0521-0522 0524 0530  
0533 0535 0542 0549-0550 0552-0553 0555 0558 0564 0567 0571 0573-0574 0578 0584  
0587-0588 0591-0595 0602-0603 0605 0607 0609 0612-0614 0616 0618 0620-0621 0623  
0631 0633-0634 0637-0638 0640-0641 0644 0647 0650 0653 0655 0657 0659-0661 0663  
0665 0667 0671 0674-0676 0678 0680 0682 0684 0686 0690-0691 0693 0695 0697  
0699-0700 0703-0705 0707-0708 0711-0712 0714 0718 0721-0722 0725 0733-0734 0738-0739  
0742-0743 0745-0747 0749 0752 0754-0755 0758 0760 0769-0770 0772 0774 0778 0784  
0789 0792 0796 0799 0801-0803 0805-0806 0811 0813-0814 0817 0819-0820 0822-0823  
0825-0828 0831 0834 0838 0841-0843 0845 0847 0849 0853 0857-0859

**MAXIMUM DEMONSTRATED CROSSWIND FOR TAKE-OFF**

Reported Braking Action	Reported Runway Friction Coefficient	Maximum demonstrated Crosswind for takeoff (kt)	Equivalent Runway Condition
Good*	≥ 0.4	32	Dry, damp, wet (< 3mm)

R MSN 0002-0011 0013-0016 0018-0029 0031-0035 0038-0044 0046-0049 0051-0053 0056-0058  
 0061 0063 0074-0076 0078-0081 0084-0085 0088-0094 0097 0101 0103-0104 0114-0115 0117  
 0123-0126 0128-0131 0133-0137 0139 0141-0142 0145-0147 0149-0152 0154 0156-0161  
 0163-0164 0166-0170 0173-0176 0178-0180 0182 0185-0187 0190 0192-0194 0196-0197 0199  
 0201-0202 0204 0207-0208 0210 0212-0218 0220-0221 0225 0227-0228 0233 0235-0237  
 0239 0242-0243 0245-0246 0252 0257 0260 0263-0264 0268 0270 0273-0274 0278 0280  
 0282 0292 0297 0302 0304 0307 0310 0318-0319 0321 0325 0327 0329 0331-0332 0335  
 0347 0352 0354-0355 0359 0363 0367 0373-0374 0377-0379 0381 0385 0387 0390 0395  
 0399 0402 0406 0411 0413-0415 0424 0429-0430 0433-0435 0438 0442 0446-0447 0450  
 0459 0467 0470 0474 0483 0528 0538 0541 0544-0546 0554 0556 0559 0561-0562 0582  
 0585 0590 0598 0643 0646 0651 0668 0793 0800 0835 0844

**MAXIMUM DEMONSTRATED CROSSWIND FOR TAKE-OFF**

Reported Braking Action	Reported Runway Friction Coefficient	Maximum Demonstrated Crosswind for takeoff (kt)	Equivalent Runway Condition
Good*	≥ 0.4	27	Dry, damp, wet (< 3mm)

**MAXIMUM CERTIFIED CROSSWIND FOR TAKEOFF**

R MSN 0371 0376 0383 0391 0394 0410 0416-0417 0426 0431 0436 0440 0445 0449 0453  
 0457 0460 0464 0468 0471 0475 0478 0482 0485 0488 0492 0495 0499 0514 0517 0520  
 0523 0531 0534 0537 0540 0543 0547 0557 0560 0563 0566 0569 0572 0575 0577 0580  
 0583 0586 0601 0604 0606 0608 0611 0615 0617 0619 0622 0624 0626 0628 0630 0639  
 0672 0677 0681 0685 0689 0694 0698 0702 0706 0710 0715 0719 0723 0727 0731 0736  
 0740 0744 0748 0753 0757 0761-0768 0771 0775 0779 0783 0787 0790 0794 0798 0804  
 0812 0829 0837 0846 0848

Reported Braking Action	Reported Runway Friction Coefficient	Maximum certified Crosswind for takeoff (kt)	Equivalent Runway Condition
Good*	≥ 0.4	35	Dry, damp, wet (< 3mm)

	<b>NORMAL OPERATIONS</b>	02.050
	TAKEOFF	JAN 09/07

R MSN 0012 0017 0071 0083 0098-0099 0102 0106 0109 0111 0113 0118 0121 0132 0138 0140 0144 0148 0153 0155 0165 0177 0234 0244 0248 0250-0251 0254 0261 0265-0266 0271 0276-0277 0279 0281 0283-0287 0293 0295 0301 0303 0306 0309 0311 0313-0314 0316 0320 0326 0328 0334 0340 0344-0345 0348-0349 0356-0357 0365 0369 0372 0382 0384 0386 0389 0392-0393 0396 0398 0400-0401 0404-0405 0407-0409 0412 0418-0421 0423 0427 0437 0439 0451-0452 0455-0456 0461-0462 0479-0480 0491 0494 0496-0497 0501 0505 0509 0512 0515 0518 0525-0527 0529 0532 0536 0539 0548 0551 0565 0568 0570 0576 0579 0581 0597 0600 0610 0625 0627 0629 0632 0635-0636 0642 0645 0648-0649 0652 0654 0656 0658 0662 0664 0666 0669-0670 0673 0679 0683 0687-0688 0692 0696 0701 0709 0713 0716-0717 0720 0724 0726 0728-0730 0732 0735 0737 0741 0750-0751 0756 0759 0773 0776-0777 0780-0782 0785-0786 0788 0791 0795 0797 0807-0810 0815 0818 0821 0824 0830 0832-0833 0836 0839-0840 0850-0852 0854-0855 0860

Reported Braking Action	Reported Runway Friction Coefficient	Maximum certified Crosswind for takeoff (kt)	Equivalent Runway Condition
Good*	≥ 0.4	32	Dry, damp, wet (< 3mm)

### AP ENGAGEMENT

R MSN 0002-0860

The AP can be engaged 5 seconds after takeoff and above 100ft RA.

### VERTICAL PROFILE

	<b>NORMAL OPERATIONS</b>  <b>TAKEOFF</b>	02.050
		JAN 09/07

R MSN 0012 0017 0030 0037 0045 0050 0054-0055 0059-0060 0062 0064-0073 0077  
0082-0083 0086-0087 0095-0096 0098-0100 0102 0106-0113 0116 0118-0122 0127 0132 0138  
0140 0143-0144 0148 0153 0155 0162 0165 0171-0172 0177 0181 0183-0184 0188-0189  
0191 0195 0198 0200 0203 0205-0206 0209 0211 0219 0222-0224 0226 0229-0232 0234  
0238 0240-0241 0244 0247-0251 0253-0256 0258-0259 0261-0262 0265-0267 0269 0271-0272  
0275-0277 0279 0281 0283-0291 0293-0296 0299-0301 0303 0305-0306 0308-0309 0311-0317  
0320 0322-0324 0326 0328 0330 0333-0334 0337-0346 0348-0351 0353 0356-0358 0361-0362  
0364-0366 0368-0370 0372 0375 0380 0382 0384 0386 0388-0389 0392-0393 0396-0398  
0400-0401 0403-0405 0407-0409 0412 0418-0423 0425 0427-0428 0432 0437 0439 0441  
0443-0444 0448 0451-0452 0454-0456 0458 0461-0463 0465-0466 0469 0472-0473 0476-0477  
0479-0481 0484 0486-0487 0489-0491 0493-0494 0496-0498 0500-0513 0515-0516 0518-0519  
0521-0522 0524-0527 0529-0530 0532-0533 0535-0536 0539 0542 0548-0553 0555 0558  
0564-0565 0567-0568 0570-0571 0573-0574 0576 0578-0579 0581 0584 0587-0588 0591-0597  
0600 0602-0603 0605 0607 0609-0610 0612-0614 0616 0618 0620-0621 0623 0625 0627  
0629 0631-0638 0640-0642 0644-0645 0647-0650 0652-0667 0669-0671 0673-0676 0678-0680  
0682-0684 0686-0688 0690-0693 0695-0697 0699-0701 0703-0705 0707-0709 0711-0714  
0716-0718 0720-0722 0724-0726 0728-0730 0732-0735 0737-0739 0741-0743 0745-0747  
0749-0752 0754-0756 0758-0760 0769-0770 0772-0774 0776-0778 0780-0782 0784-0786  
0788-0789 0791-0792 0795-0797 0799 0801-0803 0805-0811 0813-0828 0830-0834 0836  
0838-0843 0845 0847 0849-0860

SRS engages when the thrust levers are set to the applicable detent for take-off and will remain engaged until the acceleration altitude. The SRS pitch command is the minimum of the following pitches:

- . Pitch required to fly V2 +10 in All Engine Operative case (AEO)
- . Pitch required to fly IAS at the time of failure (with minimum of V2 and maximum of V2+15) in One Engine Inoperative case (OEI)
- . Pitch required to climb a 0.5° minimum climb gradient.
- . Maximum pitch attitude of 17.5° (22.5° in case of windshear)

This explains why, in many take-off, the IAS which is actually flown is neither V2+10 (AEO) nor V2 (OEI).

R MSN 0002-0011 0013-0016 0018-0029 0031-0035 0038-0044 0046-0049 0051-0053 0056-0058 0061 0063 0074-0076 0078-0081 0084-0085 0088-0094 0097 0101 0103-0104 0114-0115 0117 0123-0126 0128-0131 0133-0137 0139 0141-0142 0145-0147 0149-0152 0154 0156-0161 0163-0164 0166-0170 0173-0176 0178-0180 0182 0185-0187 0190 0192-0194 0196-0197 0199 0201-0202 0204 0207-0208 0210 0212-0218 0220-0221 0225 0227-0228 0233 0235-0237 0239 0242-0243 0245-0246 0252 0257 0260 0263-0264 0268 0270 0273-0274 0278 0280 0282 0292 0297 0302 0304 0307 0310 0318-0319 0321 0325 0327 0329 0331-0332 0335 0347 0352 0354-0355 0359 0363 0367 0371 0373-0374 0376-0379 0381 0383 0385 0387 0390-0391 0394-0395 0399 0402 0406 0410-0411 0413-0417 0424 0426 0429-0431 0433-0436 0438 0440 0442 0445-0447 0449-0450 0453 0457 0459-0460 0464 0467-0468 0470-0471 0474-0475 0478 0482-0483 0485 0488 0492 0495 0499 0514 0517 0520 0523 0528 0531 0534 0537-0538 0540-0541 0543-0547 0554 0556-0557 0559-0563 0566 0569 0572 0575 0577 0580 0582-0583 0585-0586 0590 0598 0601 0604 0606 0608 0611 0615 0617 0619 0622 0624 0626 0628 0630 0639 0643 0646 0651 0668 0672 0677 0681 0685 0689 0694 0698 0702 0706 0710 0715 0719 0723 0727 0731 0736 0740 0744 0748 0753 0757 0761-0768 0771 0775 0779 0783 0787 0790 0793-0794 0798 0800 0804 0812 0829 0835 0837 0844 0846 0848

SRS engages when the thrust levers are set to the applicable detent for take-off and will remain engaged until the acceleration altitude. The SRS pitch command is the minimum of the following pitches:

- Pitch required to fly V2 +10 in All Engine Operative case (AEO)
- Pitch required to fly IAS at the time of failure (with minimum of V2 and maximum of V2+15) in One Engine Inoperative case (OEI)
- Maximum pitch attitude of 15 ° (22.5 ° in case of windshear)
- Pitch required to climb a 0.5 ° minimum climb gradient.

This explains why, in many take-off, the IAS which is actually flown is neither V2+10 (AEO) nor V2 (OEI).

**LATERAL PROFILE**

R MSN 0002-0860

Under most circumstances, the crew can expect to follow the programmed SID. In this case, NAV is armed on selecting the thrust levers to the applicable detent for take-off and engages once above 30 ft RA.

**THRUST REDUCTION ALTITUDE**

	<b>NORMAL OPERATIONS</b>	02.050
	TAKEOFF	JAN 09/07

R MSN 0002-0860

At the thrust reduction altitude, LVR CLB<sup>®</sup> flashes on the FMA. When hand flying, lower slightly the nose, as applicable, to anticipate the pitch down FD order. Bring the thrust levers back to CLB detent. The A/THR is now active (A/THR on the FMA changes from blue to white).

The FD pitch down order depends upon the amount of thrust decrease between TOGA or FLX and CLB.

If take-off was performed packs OFF, the packs will be selected back to ON after thrust reduction because of the potential resulting EGT increase. They will be preferably selected sequentially to improve passengers comfort.

### ACCELERATION ALTITUDE

R MSN 0002-0860

At the acceleration altitude, the FD pitch mode changes from SRS to CLB or OP CLB mode. The speed target jumps:

- . Either to the managed target speed (eg; speed constraint, speed limit or ECON climb speed),
- . Or to the preselected climb speed (entered by the pilot on PERF CLB page before takeoff).

If green dot speed is higher than the managed target speed (eg: 250 kt speed limit) displayed by a magenta triangle on the PFD speed scale, the AP/FD will guide the aircraft to green dot (as per the general managed speed guidance rule). If required by ATC, the crew will select the adequate target speed (below green dot) on the FCU.

During takeoff phase, F and S speeds are the minimum speeds for retracting the surfaces:

- . At F speed, the aircraft accelerating (positive speed trend): retract to 1.
- . At S speed, the aircraft accelerating (positive speed trend): retract to 0.

If the engine start selector had been selected to IGN START for take-off, the PNF should confirm with the PF when it may be deselected.

	<b>NORMAL OPERATIONS</b>  TAKEOFF	02.050
		JAN 09/07

## TAKE-OFF AT HEAVY WEIGHT

R MSN 0002-0860

R (1)

If take-off is carried out at heavy weight, the maneuvering speed F may be close to VFEConf 2 and S speed is above VFE Conf1+F. In this case, three protections intervene:

- . The Flap Load Relief System (FLRS)
- . The Automatic Retraction System (ARS)
- . The alpha Lock function

R (2)

### **THE FLAP LOAD RELIEF SYSTEM**

When IAS reaches VFE, the FLRS is activated. It retracts automatically the flaps to the next further retracted lever position. Typically, this may occur in CONF 2, when F speed is close to VFECONF2. In this case, VFE is unchanged on PFD speed scale. (Displayed VFE remains VFE Conf 2 in accordance with the flap lever position). "RELIEF" is displayed on the E/WD Flap/Slat indication. As the aircraft accelerates above F speed, the flap lever can be selected to 1. If IAS decreases below VFE, the flaps will re-extend.

R (3)

### **THE AUTOMATIC RETRACTION SYSTEM**

While in Conf 1+F and IAS reaches 200 kts (215 kts for the A340-500 or -600), the ARS is activated. The ARS automatically retracts flaps to 0°. The VFE displayed on the PFD change from VFE CONF1+F to VFECONF. As the aircraft accelerates above S speed, the flap lever can be selected to 0. If IAS decreases below 200 kts (215 kts for the A340-500 or -600), the flaps will not extend back to 1+F.

### **THE ALPHA LOCK FUNCTION**

The slats alpha/speed lock function will prevent slat retraction at high AOA or low speed at the moment the flap lever is moved from Flaps 1 to Flaps 0. "A. LOCK" pulses above the E/WD Slat indication. The inhibition is removed and the slats retract when both alpha and speed fall within normal values. This is a



	<b>NORMAL OPERATIONS</b>	02.050
	TAKEOFF	JAN 09/07

normal situation at high gross weight. If alpha lock function is triggered, the crew will continue the scheduled acceleration, allowing further slats retraction.

**IMMEDIATE TURN AFTER TAKE-OFF**

R MSN 0002-0860

Obstacle clearance, noise abatement, or departure procedures may require an immediate turn after take-off. Provided FD commands are followed accurately, the flaps and slats may be retracted using the normal procedure as FD orders provide bank angle limits with respect to speed and configuration.

**LOW ALTITUDE LEVEL-OFF**

R MSN 0002-0860

If the aircraft is required to level off below the acceleration altitude, ALT\* engages and SRS disengages. The LVR CLB" message flashes on the FMA and the target speed goes to the initial climb speed. In this case, the crew should expect a faster than normal acceleration, and be prepared to retract the flaps and slats promptly.

**NOISE ABATEMENT TAKE-OFF**

R MSN 0002-0860

R (4)

R (5)

Noise Abatement Procedures will not be conducted in conditions of significant turbulence or windshear.

R (6)

**NOISE ABATEMENT TAKE-OFF**

Procedure NAPD 1 :  
alleviating noise close to the aerodrome

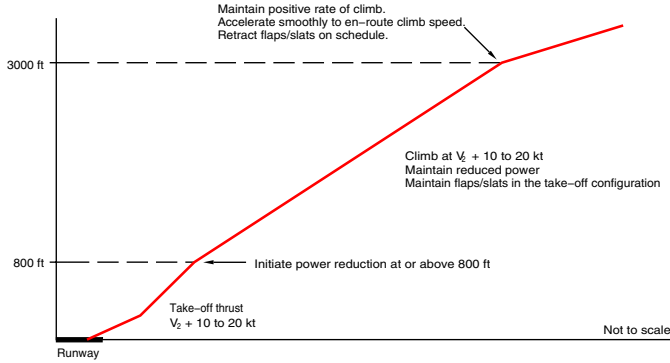

Procedure NAPD 2 :  
alleviating noise distant from the aerodrome

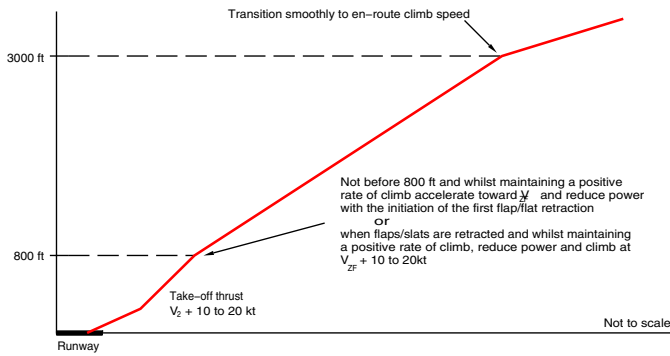

FOF 02050 00001 0001

	NORMAL OPERATIONS TAKEOFF	02.050
		JAN 09/07

### HIGHLIGHTS

- (1) Correction of printing error.
- (2) Clarification of FLRS logic: FLRS can be activated also in CONF FULL or 3
- (3) Threshold specific to A340-500/600 taken into account
- (4) Introduction of the updated ICAO NADP procedures
- (5) Deleted item 'NOISE ABATEMENT TAKE-OFF'
- (6) New item 'NOISE ABATEMENT TAKE-OFF' for 'MSN 0002-0860'

	<b>NORMAL OPERATIONS</b>  CLIMB	02.060
		JAN 09/07

### CLIMB THRUST

R MSN 0012 0017 0071 0083 0098-0099 0102 0106 0109 0111 0113 0118 0121 0132 0155  
 0177 0181 0195 0218 0220 0223 0227-0230 0232-0235 0237-0240 0244-0255 0259-0263  
 0265-0266 0269-0271 0274-0277 0279-0281 0283-0338 0340-0527 0529-0553 0555-0860

During the climb, the thrust levers are in the CL detent, the A/THR is active in thrust mode and the FADECs manage the thrust to a maximum value depending upon ambient conditions.

Engine life may be extended by operating the engines at less than maximum climb rated thrust. Two levels of derated climb thrust can be selected on the PERF CLB page:

- . D1, which reduces the maximum climb thrust by 5 to 10 %.
- . D2, which reduces the maximum climb thrust by 10 to 15 %.

If a derated climb has been entered prior to departure, then "THR DCLB 1(2)" will be displayed on the FMA as the thrust levers are set to CL detent at the thrust reduction altitude. During the latter stage of a climb to higher levels, the derate is progressively reduced to zero by the FADECs. Climb performance will be reduced when using derated climb thrust but the ceiling will not be affected. The crew may modify or cancel the level of derate at any stage through the MCDU PERF CLB page.

Should an engine failure occur during a derated climb, derated climb thrust is deselected by selecting MCT.

The derated climb slightly increases fuel consumption and must be taken into account for fuel quantity computation (See FCOM 3.05.10).

R MSN 0002-0860

### AP/FD CLIMB MODES

The AP/FD climb modes may be either

- . Managed
- . Selected

### **MANAGED**

	<b>NORMAL OPERATIONS</b>	02.060
	CLIMB	JAN 09/07

The managed AP/FD mode in climb is CLB. Its use is recommended as long as the aircraft is cleared along the F-PLN.

### **SELECTED**

The selected AP/FD modes in climb are OP CLB or V/S.

OP CLB is to be used if ATC gives radar vector or clears the aircraft direct to a given FL without any climb constraints.

If the crew selects a high V/S, it may happen that the aircraft is unable to climb with this high V/S and to maintain the target speed with Max Climb thrust, for performance reasons. In that case, the AP/FD will guide to the target V/S, and the ATHR will command up to Max Climb thrust, in order to try to keep the target speed; but the aircraft will decelerate and its speed might reach VLS. When VLS is reached the AP will pitch the aircraft down so as to fly a V/S, which allows maintaining VLS. In this case, the V/S indication on the FMA pulses and is boxed amber. A triple click is generated (if triple click option is available)

Whenever V/S is used, pilots should pay particular attention to the speed trend as V/S takes precedence over speed requirements.

The crew should be aware that altitude constraints in the MCDU F-PLN page are observed only when the climb is managed, i.e. when CLB is displayed on the FMA. Any other vertical mode will disregard any altitude constraints.

A likely scenario would be, when the FCU altitude is set above an altitude constraint and the pilot selects V/S when below that constraint to avoid a potential TCAS TA. In this case, the aircraft will disregard the altitude constraint.

### **SMALL ALTITUDE CHANGES**

R MSN 0002-0860

CLB or OP CLB mode will be preferred to VS mode for climb even for small altitude changes. Indeed, in the small altitude change case, the THR CLB mode is limited in order to give 1000 fpm making this altitude change smoother and more comfortable for the passengers.

### **SPEED CONSIDERATIONS**

R MSN 0002-0860

	<b>NORMAL OPERATIONS</b>  CLIMB	02.060
		JAN 09/07

The climb speed may be either:

- . Managed
- . Selected

### **MANAGED**

The managed climb speed, computed by the FMGS, provides the most economical climb profile as it takes into account weight, actual and predicted winds, ISA deviation and Cost Index (CI). The managed climb speed also takes into account any speed constraints, e.g. the default speed limit which is 250 kts up to 10000 ft.

### **SELECTED**

If necessary, the climb speed can be either pre-selected on ground prior to take-off on the MCDU PERF CLIMB page or selected on the FCU as required.

On ground, prior take-off, speed target at acceleration altitude can be pre-selected on the MCDU PERF CLIMB page. It is to be used when the F-PLN has a sharp turn after take-off, when high angle of climb is required or for ATC clearance compliance.

Once airborne, the speed can be selected on FCU to achieve the maximum rate of climb or the maximum gradient of climb.

The speed to achieve the maximum rate of climb, i.e. to reach a given altitude in the shortest time, lies between ECON climb speed and green dot. As there is no indication of this speed on the PFD, a good rule of thumb is to use turbulence speed to achieve maximum rate.

The speed to achieve the maximum gradient of climb, i.e. to reach a given altitude in a shortest distance, is green dot. The MCDU PERF CLB page displays the time and distance required to achieve the selected altitude by climbing at green dot speed. Avoid reducing to green dot at high altitude, particularly at heavy weight, as it can take a long time to accelerate to ECON mach.

Pilots should be aware that it is possible to select and fly a speed below green dot but there would be no operational benefit in doing this.

When selected speed is used, the predictions on the F-PLN page assume the selected speed is kept till the next planned speed modification, e.g. 250 kts /10.000 ft, where managed speed is supposed to be resumed. Consequently, the FM predictions remain meaningful.

When IAS is selected in lower altitude, there is an automatic change to Mach at a specific crossover altitude.

	<b>NORMAL OPERATIONS</b>	02.060
	<b>CLIMB</b>	JAN 09/07

Finally, as selected speed does not provide the optimum climb profile, it should only be used when operationally required, e.g. ATC constraint or weather.

### VERTICAL PERFORMANCE PREDICTIONS

R MSN 0002-0860

The MCDU PROG page provides the crew with the MAX REC ALT and with the OPT ALT information (See cruise section). This information is to be used to rapidly answer to ATC: "CAN YOU CLIMB TO FL XXX?"

The MCDU PERF CLB page provides predictions to a given FL in terms of time and distance assuming CLB mode. This FL is defaulted to the FCU target altitude or it may be manually inserted. The **symbol** level arrow on the ND assumes the current AP engaged mode. This information is to be used to rapidly answer to ATC: "CAN YOU MAKE FL XXX by ZZZ waypoint?". The crew will use a PD, i.e. ZZZ,-10 waypoint if the question is "CAN YOU MAKE FL XXX , 10 NM before ZZZ point?"

### LATERAL NAVIGATION

R MSN 0002-0860

If the aircraft is following the programmed SID, the AP/FD should be in NAV. If ATC vectors the aircraft, HDG will be used until a time when clearance is given to either resume the SID or track direct to a specific waypoint. In either case, the crew must ensure that the waypoints are properly sequenced.

The crew should keep in mind that the use of HDG mode e.g. following ATC radar vectors, will revert CLB to OP CLB and any altitude constraints in the MCDU FPLN page will not be observed unless they are selected on the FCU.

### 10.000 FT FLOW PATTERN

R MSN 0002-0860

10.000 FT FLOW PATTERN

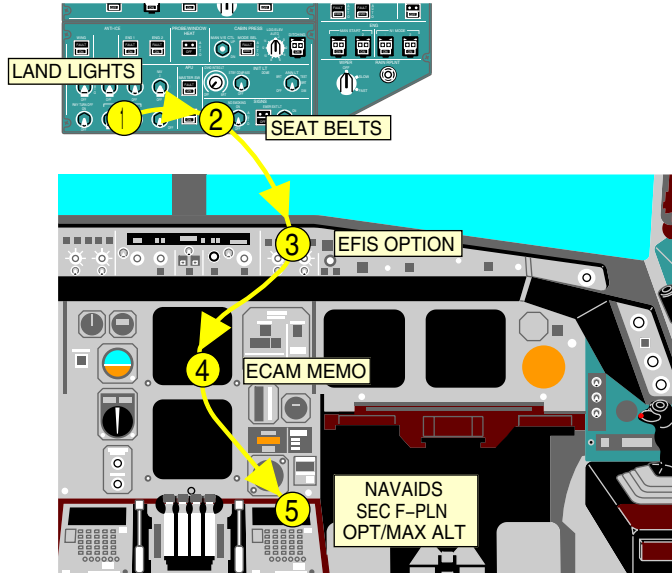

FOF 02060 03847 0001

EFIS Option:

The PF will select CSTR for grid MORA

The PNF will select ARPT



	<b>NORMAL OPERATIONS</b>	02.070
	CRUISE	JAN 09/07

R MSN 0002-0860

### PREFACE

Once the cruise flight level is reached, "ALT CRZ" is displayed on the FMA. The cruise Mach number is targeted and cruise fuel consumption is optimized.

### FMS USE

R MSN 0002-0860

### CRUISE FL

If the aircraft is cleared to a lower cruise flight level than the pre-planned cruise flight level displayed on MCDU PROG page, "ALT CRZ" will not be displayed on the FMA and cruise Mach number will not be targeted. The crew will update the MCDU PROG page accordingly.

When in cruise i.e. ALT CRZ on FMA, the thrust control is soft. This means that the thrust will allow small speed variation around the cruise Mach (typically  $\pm 4$  kts) before a readjustment of thrust occurs. This optimizes the fuel consumption in cruise.

### WIND AND TEMPERATURE

When reaching cruise FL, the crew will ensure that the wind and temperatures are correctly entered and the lateral and vertical F-PLN reflect the CFP. Wind entries should be made at waypoints when there is a difference of either 30° or 30 kt for the wind data and 5 °C for temperature deviation. These entries should be made up to four different levels to reflect the actual wind and temperature profile. This will ensure that the FMS fuel and time predictions are as accurate as possible and provide an accurate OPT FL computation.

### STEP CLIMB

If there is a STEP in the F-PLN, the crew will ensure that the wind is properly set at the first waypoint beyond the step (D on the following example) at both initial FL and step FL.

#### STEPCLIMB AND WIND PROPAGATION RULE

	<b>NORMAL OPERATIONS</b>  <b>CRUISE</b>	02.070
		JAN 09/07

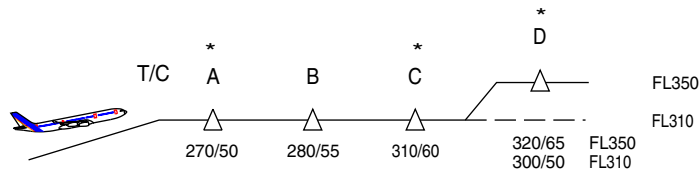

\* are the points where an entry shall be done.

FOF 02070 03848 0001

If at D waypoint, the CFP provides the wind at FL350 but not at FL310, it is recommended to insert the same wind at FL310 as the one at FL350. This is due to wind propagation rules, which might affect the optimum FL computation.

## ETP

The ETP function should be used to assist the crew in making a decision should an en-route diversion be required. Suitable airport pairs should be entered on the ETP page and the FMS will then calculate the ETP. Each time an ETP is sequenced, the crew should insert the next suitable diversion airfield.

The SEC F-PLN is a useful tool and should be used practically. The ETP should be inserted in the SEC F-PLN as a PD (Place/Distance) and the route to diversion airfield should be finalized. By programming a potential en-route diversion, the crew would reduce their workload should a failure occur. This is particularly true when terrain considerations apply to the intended diversion route. When an ETP is sequenced, the crew will

- . Access to the ETP page
- . Insert the next applicable diversion airfield with associated wind
- . Read new ETP
- . Insert new ETP as a PD
- . Copy active on the SEC F-PLN
- . Insert the new diversion as New Dest in the SEC F-PLN from new ETP

### EXAMPLE OF SEC F-PLN USE DURING CRUISE

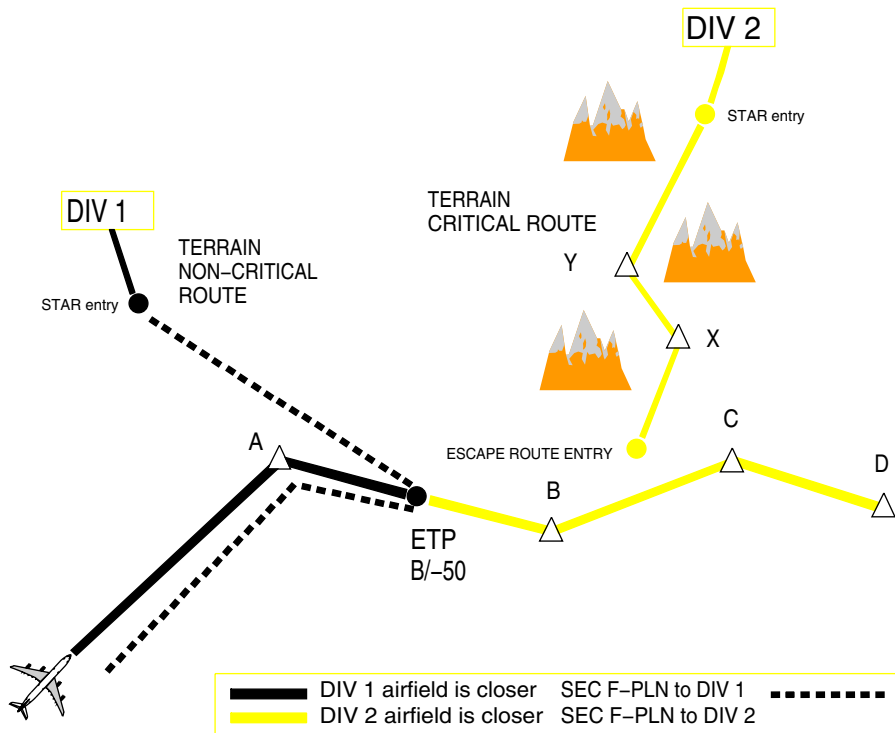

FOF 02070 03849 0001

The DATA/Stored Routes function in the MCDU can be used to store up to five possible diversion routes. These routes can be entered into the SEC F-PLN using the SEC INIT prompt. This prompt will only be available if the SEC F-PLN is deleted. See FCOM 4.04.30 for further information

For diversion purpose, the crew can also use the CLOSEST AIRPORT page which provides valuable fuel/time estimates to the four closest airports from the aircraft position, as well as to an airport the crew may define. The fuel and time predictions are a function of the average wind between the aircraft and the airport.

**MISCELLANEOUS**

If ATC requires for a position report, the crew will use the REPORT page which can be accessed from PROG page.

	<b>NORMAL OPERATIONS</b>	02.070
	CRUISE	JAN 09/07

If ATC modifies the routing, the crew will revise the F-PLN. Once achieved, the crew may perform a new F-PLN print.

If ATC requires to report on a given radial, the crew will use the FIX INFO page which can be accessed from a lateral revision on F-PLN page at PPOS.

If ATC requires a report at a given time, the crew will insert a time marker pseudo waypoint.

If there is weather, the crew will use the OFFSET function which can be accessed from a lateral revision at PPOS. The crew will determine how many NM are required to avoid the weather. Once cleared by ATC, the crew will insert the offset.

If ATC gives a DIR TO clearance to a waypoint far from present position, the crew will use the ABEAM facility. This facility allows both a better crew orientation and the previously entered winds to be still considered.

## COST INDEX

R MSN 0002-0860

The Cost Index (CI) is used to take into account the relationship between fuel and time related costs in order to minimize the trip cost. The CI is calculated by the airline for each sector. From an operational point of view, the CI affects the speeds (ECON SPEED/MACH) and cruise altitude (OPT ALT). CI=0 corresponds to maximum range whereas the CI=999 corresponds to minimum time.

The CI is a strategic parameter which applies to the whole flight. However, the CI can be modified by the crew in flight for valid strategic operational reasons. For example, if the crew needs to reduce the speed for the entire flight to comply with curfew requirements or fuel management requirements (XTRA gets close to 0), then it would be appropriate to reduce the CI.

The SEC F-PLN can be used to check the predictions associated with new CI. If they are satisfactory, the crew will then modify the CI in the primary F-PLN. However, the crew should be aware that any modification of the CI would affect trip cost.

## SPEED CONSIDERATIONS

	<b>NORMAL OPERATIONS</b>	02.070
	<b>CRUISE</b>	JAN 09/07

R MSN 0002-0860

The cruise speed may be either:

- . Managed
- . Selected

### **MANAGED**

When the cruise altitude is reached, i.e. "ALT CRZ " on the FMA, the A/THR operates in SPEED/MACH mode. The optimum cruise Mach number is automatically targeted. Its value depends on:

- . CI
- . Cruise flight level
- . Temperature deviation
- . Weight
- . Headwind component.

The crew should be aware that the optimum Mach number will vary according to the above mentioned parameters, e.g. it will increase with an increasing headwind, e.g. + 50kt head wind equates to + 0.01 Mach.

Should ATC require a specific time over a waypoint, the crew can perform a vertical revision on that waypoint and enter a time constraint. The managed Mach number would be modified accordingly, between green dot and M0.84, to achieve this constraint. If the constraint can be met, i.e. within  $\pm 2$  minutes, a magenta asterix will be displayed on the MCDU; if the constraint cannot be met, an amber asterix will be displayed. Once the constrained waypoint is sequenced, the ECON Mach is resumed.

### **SELECTED**

Should ATC require a specific cruise speed or turbulence penetration is required, the pilot must select the cruise speed on the FCU. FMS predictions are updated accordingly until reaching either the next step climb or top of descent, where the programmed speeds apply again. The FMS predictions are therefore realistic.

At high altitude, the speed should not be reduced below GREEN DOT as this may create a situation where it is impossible to maintain speed and/or altitude as the increased drag may exceed the available thrust.

	<b>NORMAL OPERATIONS</b>	02.070
	<b>CRUISE</b>	JAN 09/07

**ALTITUDE CONSIDERATIONS**

R MSN 0002-0860

The MCDU PROG page displays:

- . REC MAX FL
- . OPT FL.

**REC MAX FL**

REC MAX FL reflects the present engine and wing performance and does not take into account the cost aspect. It provides a 0.3g buffet margin. If the crew inserts a FL higher than REC MAX into the MCDU, it will be accepted only if it provides a buffet margin greater than 0.2g. Otherwise, it will be rejected and the message "CRZ ABOVE MAX FL" will appear on the MCDU scratchpad. Unless there are overriding operational considerations, e.g. either to accept a cruise FL higher than REC MAX or to be held significantly lower for a long period, REC MAX should be considered as the upper cruise limit.

**OPT FL**

OPT FL displayed on the MCDU is the cruise altitude for minimum cost when ECON MACH is flown and should be followed whenever possible. It is important to note that the OPT FL displayed on the PROG page is meaningful only if the wind and temperature profile has been accurately entered. The crew should be aware that flying at a level other than the OPT FL would adversely affect the trip cost.

For each Mach number, there will be a different OPT FL. Should an FMGS failure occur, the crew should refer to the FCOM or QRH to determine the OPT FL. FCOM and QRH charts are only provided for four different Mach numbers.

**STEP CLIMB**

R MSN 0002-0860

	<b>NORMAL OPERATIONS</b>	02.070
	<b>CRUISE</b>	JAN 09/07

Since the optimum altitude increases as fuel is consumed during the flight, from a cost point of view, it is preferable to climb to a higher cruise altitude when aircraft weight permits. This technique, referred to as a Step Climb, is typically accomplished by initially climbing approximately 2000 ft above the optimum altitude and then cruising at that flight level until approximately 4000 ft below optimum.

Step climbs can either be planned at waypoints or be optimum step points calculated by the FMGS. In order to determine the optimum location of the next FL change, the crew will use the OPT STEP facility on the STEP ALT page and insert the next FL. If predictions are satisfactory in term of time and fuel saving, the crew will insert it in F-PLN provided it is compatible with ATC. The inserted step climb is set as a (S/C) geographic waypoint. It may be updated by pressing the UPDATE\* prompt on the STEP page.

The OPT STEP computation will be accurate if vertical wind profile has been properly entered. Refer to FMS USE of this section. The FCOM 3.05.15 provides valuable tables to assess the effect of the vertical wind profile on the optimum cruise flight level.

It may be advantageous to request an initial cruise altitude above optimum if altitude changes are difficult to obtain on specific routes. This minimizes the possibility of being held at a low altitude and high fuel consumption condition for long periods of time. The requested/cleared cruise altitude should be compared to the REC MAX altitude. Before accepting an altitude above optimum, the crew should determine that it will continue to be acceptable considering the projected flight conditions such as turbulence, standing waves or temperature change.

OPT FL FOLLOW UP

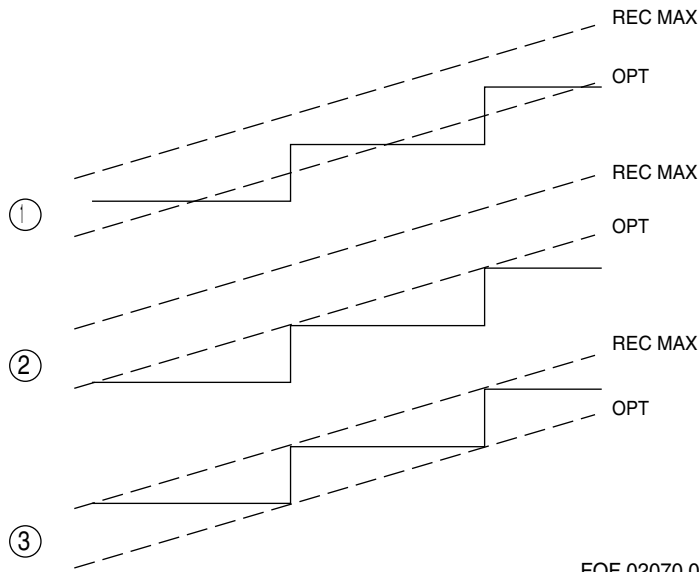

FOF 02070 03852 0001

The diagram above shows three step climb strategies with respect to OPT and REC MAX FL. Strategy 1 provides the best trip cost, followed by 2 then 3.

**EFFECT OF ALTITUDE ON FUEL CONSUMPTION**



	<b>NORMAL OPERATIONS</b>  <b>CRUISE</b>	02.070
		JAN 09/07

R MSN 0012 0017 0030 0037 0045 0050 0054-0055 0059-0060 0062 0064-0073 0077  
0082-0083 0086-0087 0095-0096 0098-0100 0102 0106-0113 0116 0118-0122 0127 0132 0138  
0140 0143-0144 0148 0153 0155 0162 0165 0171-0172 0177 0181 0183-0184 0188-0189  
0191 0195 0198 0200 0203 0205-0206 0209 0211 0219 0222-0224 0226 0229-0232 0234  
0238 0240-0241 0244 0247-0251 0253-0256 0258-0259 0261-0262 0265-0267 0269 0271-0272  
0275-0277 0279 0281 0283-0291 0293-0296 0299-0301 0303 0305-0306 0308-0309 0311-0317  
0320 0322-0324 0326 0328 0330 0333-0334 0337-0346 0348-0351 0353 0356-0358 0361-0362  
0364-0366 0368-0370 0372 0375 0380 0382 0384 0386 0388-0389 0392-0393 0396-0398  
0400-0401 0403-0405 0407-0409 0412 0418-0423 0425 0427-0428 0432 0437 0439 0441  
0443-0444 0448 0451-0452 0454-0456 0458 0461-0463 0465-0466 0469 0472-0473 0476-0477  
0479-0481 0484 0486-0487 0489-0491 0493-0494 0496-0498 0500-0513 0515-0516 0518-0519  
0521-0522 0524-0527 0529-0530 0532-0533 0535-0536 0539 0542 0548-0553 0555 0558  
0564-0565 0567-0568 0570-0571 0573-0574 0576 0578-0579 0581 0584 0587-0588 0591-0597  
0600 0602-0603 0605 0607 0609-0610 0612-0614 0616 0618 0620-0621 0623 0625 0627  
0629 0631-0638 0640-0642 0644-0645 0647-0650 0652-0667 0669-0671 0673-0676 0678-0680  
0682-0684 0686-0688 0690-0693 0695-0697 0699-0701 0703-0705 0707-0709 0711-0714  
0716-0718 0720-0722 0724-0726 0728-0730 0732-0735 0737-0739 0741-0743 0745-0747  
0749-0752 0754-0756 0758-0760 0769-0770 0772-0774 0776-0778 0780-0782 0784-0786  
0788-0789 0791-0792 0795-0797 0799 0801-0803 0805-0811 0813-0828 0830-0834 0836  
0838-0843 0845 0847 0849-0860

The selected cruise altitude should normally be as close to optimum as possible. As deviation from optimum cruise altitude increases, performance economy decreases. As a general rule:

- . Flying 2000ft above optimum altitude results in fuel penalty of approximately 2.5%
- . Flying 4000ft below optimum altitude results in fuel penalty of approximately 5%
- . Flying 2000ft below optimum altitude results in fuel penalty of approximately 1.5%

Consequently, flying at a level other than OPT FL will adversely affect the trip cost.

FUEL PENALTY VERSUS OPT FL

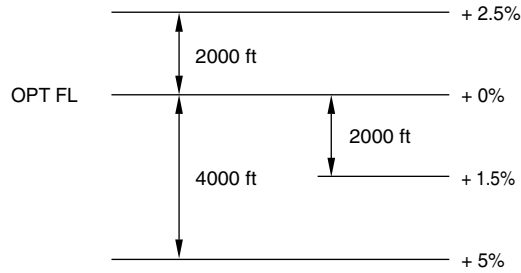

FOF 02070 03873 0001

R MSN 0002-0011 0013-0016 0018-0029 0031-0035 0038-0044 0046-0049 0051-0053 0056-0058  
 0061 0063 0074-0076 0078-0081 0084-0085 0088-0094 0097 0101 0103-0104 0114-0115 0117  
 0123-0126 0128-0131 0133-0137 0139 0141-0142 0145-0147 0149-0152 0154 0156-0161  
 0163-0164 0166-0170 0173-0176 0178-0180 0182 0185-0187 0190 0192-0194 0196-0197 0199  
 0201-0202 0204 0207-0208 0210 0212-0218 0220-0221 0225 0227-0228 0233 0235-0237  
 0239 0242-0243 0245-0246 0252 0257 0260 0263-0264 0268 0270 0273-0274 0278 0280  
 0282 0292 0297 0302 0304 0307 0310 0318-0319 0321 0325 0327 0329 0331-0332  
 0335 0347 0352 0354-0355 0359 0363 0367 0371 0373-0374 0376-0379 0381 0383 0385  
 0387 0390-0391 0394-0395 0399 0402 0406 0410-0411 0413-0417 0424 0426 0429-0431  
 0433-0436 0438 0440 0442 0445-0447 0449-0450 0453 0457 0459-0460 0464 0467-0468  
 0470-0471 0474-0475 0478 0482-0483 0485 0488 0492 0495 0499 0514 0517 0520 0523  
 0528 0531 0534 0537-0538 0540-0541 0543-0547 0554 0556-0557 0559-0563 0566 0569  
 0572 0575 0577 0580 0582-0583 0585-0586 0590 0598 0601 0604 0606 0608 0611 0615  
 0617 0619 0622 0624 0626 0628 0630 0639 0643 0646 0651 0668 0672 0677 0681 0685  
 0689 0694 0698 0702 0706 0710 0715 0719 0723 0727 0731 0736 0740 0744 0748 0753  
 0757 0761-0768 0771 0775 0779 0783 0787 0790 0793-0794 0798 0800 0804 0812 0829  
 0835 0837 0844 0846 0848

The selected cruise altitude should normally be as close to optimum as possible. As deviation from optimum cruise altitude increases, performance economy decreases. As a general rule:

- . Flying 2000ft above optimum altitude results in fuel penalty of approximately 1.5%
- . Flying 4000ft below optimum altitude results in fuel penalty of approximately 5%
- . Flying 2000ft below optimum altitude results in fuel penalty of approximately 1.5%

Consequently, flying at a level other than OPT FL will adversely affect the trip cost.

FUEL PENALTY VERSUS OPT FL

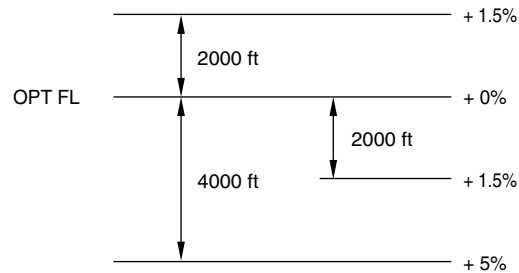

FOF 02070 03874 0001

**FUEL MONITORING**

R MSN 0002-0860

The flight plan fuel burn from departure to destination is based on certain assumed conditions. These include gross weight, cruise altitude, route of flight, temperature, cruise wind and cruise speed. Actual fuel consumption should be compared with the flight plan fuel consumption at least once every 30 minutes.

The crew should be aware that many factors influence fuel consumption, such as actual flight level, cruise speed and unexpected meteorological conditions. These parameters should normally be reflected in the FMS.

The crew must keep in mind that

- . A significant deviation between planned and actual fuel figures without reason
- . An excessive fuel flow leading to a potential imbalance
- . An abnormal decrease in total fuel quantity (FOB+FU)

May indicate a fuel leak and the associated procedure should be applied.

**FUEL TEMPERATURE**

	<b>NORMAL OPERATIONS</b>	02.070
	<b>CRUISE</b>	JAN 09/07

R MSN 0002-0860

Fuel freeze refers to the formation of wax crystals suspended in the fuel, which can accumulate when fuel temperature is below the freeze point (-47 °C for jet A1) and can prevent proper fuel feed to the engines.

During normal operations, fuel temperature rarely decreases to the point that it becomes limiting. However, extended cruise operations increase the potential for fuel temperatures to reach the freeze point. Fuel temperature will slowly reduce towards TAT. The rate of cooling of fuel can be expected to be in the order of 3 °C per hour with a maximum of 12 °C per hour in the most extreme conditions.

If fuel temperature approaches the minimum allowed, consideration should be given to achieving a higher TAT:

- . Descending or diverting to a warmer air mass may be considered. Below the tropopause, a 4000 ft descent gives a 7 °C increase in TAT. In severe cases, a descent to as low as 25,000 ft may be required.
- . Increasing Mach number will also increase TAT. An increase of 0.01 Mach produces approximately 0.7 °C increase in TAT.

In either case, up to one hour may be required for fuel temperature to stabilise. The crew should consider the fuel penalty associated with either of these actions.

#### APPROACH PREPARATION

R MSN 0002-0860

The latest destination weather should be obtained approximately 15 minutes prior to descent and the FMGS programmed for the descent and arrival. During FMGS programming the PF will be head down, so it is important that the PNF does not become involved in any tasks other than flying the aircraft. The fuel predictions will be accurate if the F-PLN is correctly entered in terms of arrival, go-around and alternate routing.

The FMGS will be programmed as follows:

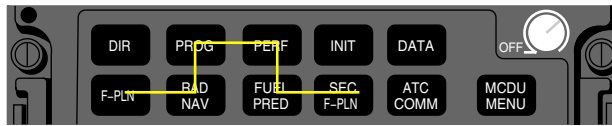

FOF 02070 03868 0001

## **FPLN**

Introductory text if necessary.

Lateral: Landing runway, STAR, Approach, Go-around procedure, F-PLN to alternate.

Vertical: Altitude and Speed constraints, Compare vertical FPLN on MCDU with approach chart

### MCDU F-PLN PAGE VS APPROACH CHART CROSSCHECK

FROM	UTC	NO SEQ	→
T-P	1432	161 /	3000
	BRG319°	1NM	
CD33R	1435	161 / *	3000
<b>C324°</b>	TRK324°	4	3.1
FD33R	1437	161 / *	1520
<b>C324°</b>		3	3.1
MD33R	1438	137 /	550
C324°		5	
TOU Δ	----	---/+	900
DEST	TIME	DIST	EFBO
LFBO33R	1438	8	4.6

Compare vertical F-PLN on MCDU with Approach Chart

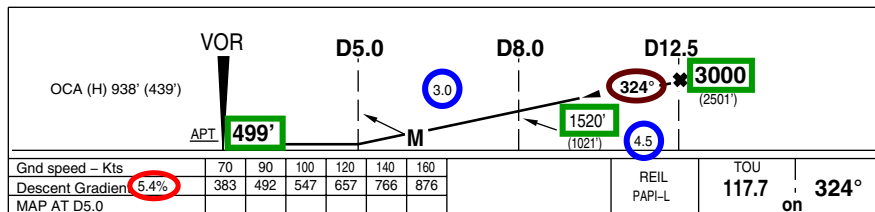

FOF 02070 03869 0001

**RAD NAV**

Manually tune the VOR/DME and/or NDB if required. Check ILS ident, frequency and associated course of destination airfield as required. It is not recommended manually forcing the ILS identifier as, in case of late runway change, the associated ILS would not be automatically tuned.

**PROG**

Insert VOR/DME or landing runway threshold of destination airfield in the BRG/DIST field as required.

**PERF**

	<b>NORMAL OPERATIONS</b>	02.070
	<b>CRUISE</b>	JAN 09/07

**PERF APPR:**

- . Descent winds,
- . Destination airfield weather (QNH, Temperature and wind) The entered wind should be the average wind given by the ATC or ATIS. Do not enter gust values, for example, if the wind is 150/20-25, insert the lower speed 150/20 (With managed speed mode in approach, ground speed mini-function will cope with the gusts).
- . Minima (DH for CAT 2 or 3 approach and MDA for others approaches)
- . Landing configuration (wind shear anticipated or in case of failure).

PERF GO AROUND: Check thrust reduction and acceleration altitude.

**FUEL PRED**

Check estimated landing weight, EFOB and extra fuel.

**SEC F-PLN**

To cover contingencies e.g. runway change, circling or diversion.

Once the FMGS has been programmed, the PNF should then cross check the information prior to the approach briefing.

**APPROACH BRIEFING**

R MSN 0002-0860

The main objective of the approach briefing is for the PF to inform the PNF of his intended course of action for the approach. The briefing should be practical and relevant to the actual weather conditions expected. It should be concise and conducted in a logical manner. It should be given at a time of low workload if possible, to enable the crew to concentrate on the content. It is very important that any misunderstandings are resolved at this time.

PF briefing	Associated cross check
<b>Aircraft type and technical status</b>	
<b>NOTAM</b>	
<b>Weather</b>	

- Accessibility	
- Runway in use	
<b>Fuel</b>	
- Extra fuel	FUEL PRED page
<b>Descent</b>	
- TOD (time, position)	FPLN page
- MORA, STAR, MSA	FPLN page
- Altitude and speed constraints	
<b>Holding (if expected)</b>	
- Entry in holding pattern	
- MHA and MAX speed	
<b>Approach</b>	
- Approach type	- PERF APPR and ND
- Altitude and FAF identification	- FPLN
- Descend gradient	- PFD/FMA
- MDA/DH	- PERF APPR
- Missed approach procedure	- FPLN
- Alternate considerations	- FPLN
<b>Landing</b>	
- Runway condition, length and width	
- Tail strike awareness	
- Use of Auto brake	
- Expected taxi clearance	
<b>Radio aids</b>	RAD NAV



	<b>NORMAL OPERATIONS</b>	02.080
	DESCENT	JAN 09/07

## PREFACE

R MSN 0002-0860

The PF will set preferably the MCDU PROG or PERF page as required (PROG page provides VDEV in NAV mode and BRG/DIST information, PERF DES page provides predictions down to any inserted altitude in DES/OP DES modes) whereas the PNF will set the MCDU F-PLN page.

If use of radar is required, consider selecting the radar display on the PF side and TERR on PNF side only.

## COMPUTATION PRINCIPLES

R MSN 0002-0860

### TOD AND PROFILE COMPUTATION

The FMGS calculates the Top Of Descent point (TOD) backwards from a position 1000 ft on the final approach with speed at VAPP. It takes into account any descent speed and altitude constraints and assumes managed speed is used. The first segment of the descent will always be idle segment until the first altitude constraint is reached. Subsequent segments will be "geometric", i.e. the descent will be flown at a specific angle, taking into account any subsequent constraints. If the STAR includes a holding pattern, it is not considered for TOD or fuel computation. The TOD is displayed on the ND track as a symbol:

#### DESCENT PATH

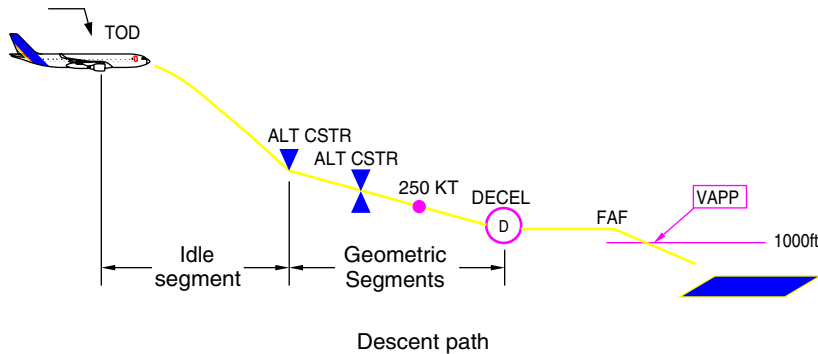

FOF 02080 03892 0001

The idle segment assumes a given managed speed flown with idle thrust plus a small amount of thrust. This gives some flexibility to keep the aircraft on the descent path if engine anti-ice is used or if winds vary. This explains THR DES on the FMA.

The TOD computed by the FMS is reliable provided the flight plan is properly documented down to the approach.

**MANAGED DESCENT SPEED PROFILE**

The managed speed is equal to:

- . The ECON speed (which may have been modified by the crew on the PERF DES page, before entering DESCENT phase), or
- . The speed constraint or limit when applicable.

**GUIDANCE AND MONITORING**

R MSN 0002-0860  
 R (1)

**INTRODUCTION**

	<b>NORMAL OPERATIONS</b>	02.080
	DESCENT	JAN 09/07

To carry out the descent, the crew can use either the managed descent mode (DES) or the selected descent modes (OP DES or V/S). Both descent modes can be flown either with selected speed or managed speed.

The modes and monitoring means are actually linked.

The **managed DES mode** guides the aircraft along the FMS pre-computed descent profile, as long as it flies along the lateral F-PLN: i.e. DES mode is available if NAV is engaged. As a general rule when DES mode is used, the descent is monitored using VDEV called "yoyo" on PFD, or its digital value on the PROG page, as well as the level arrow on the ND.

The **selected OPDES or V/S modes** are used when HDG is selected or when ALT CSTR may be disregarded or for various tactical purposes. As a general rule when OPDES or V/S modes are used, the descent is monitored using the Energy Circle, (displayed if HDG or TRK modes and indicating the required distance to descend, decelerate and land from present position) and the level arrow on the ND. When the aircraft is not far away from the lateral F-PLN (small XTK), the yoyo on PFD is also a good indicator.

### **MANAGED DESCENT MODE**

The managed descent profile from high altitude is approximately 2.5°.

As an estimation of the distance to touchdown is required to enable descent profile monitoring, it is important to ensure that the MCDU F-PLN plan page reflects the expected approach routing. Any gross errors noted in the descent profile are usually a result of incorrect routing entered in the MCDU or non-sequencing of F-PLN waypoints, giving a false distance to touchdown.

### **DESCENT INITIATION**

To initiate a managed descent, the pilot will set the ATC cleared altitude on the FCU and push the ALT selector. DES mode engages and is annunciated on the FMA. If an early descent were required by ATC, DES mode would give 1000 fpm rate of descent, until regaining the computed profile.

To avoid overshooting the computed descent path, it is preferable to push the FCU ALT selector a few miles prior to the calculated TOD. This method will ensure a controlled entry into the descent and is particularly useful in situations of high cruise Mach number or strong tail winds.

If the descent is delayed, a "DECELERATE" message appears in white on the PFD and in amber on the MCDU. Speed should be reduced towards green dot, and when cleared for descent, the pilot will push for DES and push for managed speed. The speed reduction prior to descent will enable the aircraft to recover the computed profile more quickly as it accelerates to the managed descent speed.

**DESCENT PROFILE**

When DES with managed speed is engaged, the AP/FD guides the aircraft along the pre-computed descent path determined by a number of factors such as altitude constraints, wind and descent speed. However, as the actual conditions may differ from those planned, the DES mode operates within a 20 kts speed range around the managed target speed to maintain the descent path.

MANAGED DESCENT: SPEED TARGET RANGE PRINCIPLE

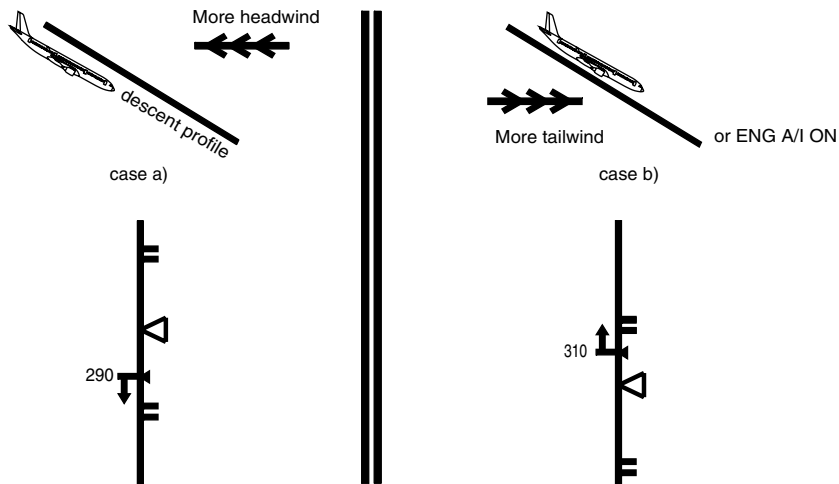

FOF 02080 03893 0001

**If the aircraft gets high on the computed descent path:**

- . The speed will increase towards the upper limit of the speed range, to keep the aircraft on the path with IDLE thrust.
- . If the speed reaches the upper limit, THR IDLE is maintained, but the autopilot does not allow the speed to increase any more, thus the VDEV will slowly increase.
- . A path intercept point, which assumes half speedbrake extension, will be displayed on the ND descent track.
- . If speed brakes are not extended, the intercept point will move forward. If it gets close to an altitude constrained waypoint, then a message "EXTEND SPEEDBRAKES" will be displayed on the PFD and MCDU.

This technique allows an altitude constraint to be matched with minimum use of speedbrakes.

When regaining the descent profile, the speedbrakes should be retracted to prevent the A/THR applying thrust against speedbrakes. If the speedbrakes are not retracted, the "SPD BRK" message on the ECAM memo becomes amber and "RETRACT SPEEDBRAKES" is displayed in white on the PFD.

A/C ABOVE DESCENT PATH

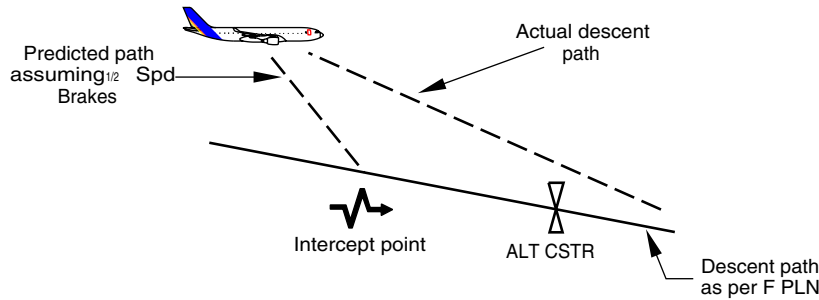

FOF 02080 03894 0001

**If the aircraft gets low on the computed descent path:**

The speed will decrease towards the lower limit of the speed range with idle thrust. When the lower speed limit is reached the A/THR will revert to SPEED/MACH mode and apply thrust to maintain the descent path at this lower speed. The path intercept point will be displayed on the ND, to indicate where the descent profile will be regained.

A/C BELOW DESCENT PATH

	<b>NORMAL OPERATIONS</b>  DESCENT	02.080
		JAN 09/07

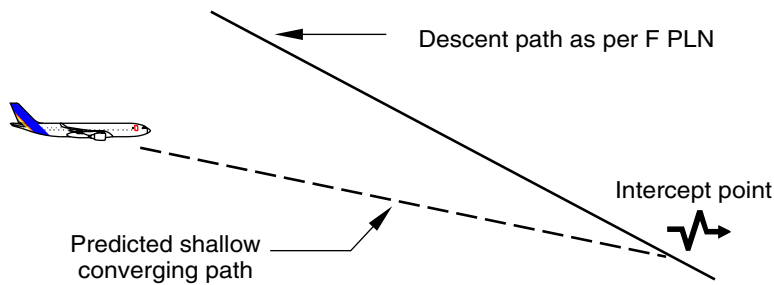

FOF 02080 03895 0001

**If is selected speed is used:**

The descent profile remains unchanged. As the selected speed may differ from the speed taken into account for pre-computed descent profile and speed deviation range does not apply, the aircraft may deviate from the descent profile e.g. if the pilot selects 275 kts with a pre-computed descent profile assuming managed speed 300 kts, VDEV will increase.

**SELECTED DESCENT MODE**

There are 2 modes for flying a selected descent, namely OP DES and V/S. These modes will be used for pilot tactical interventions.

V/S mode is automatically selected when HDG or TRK mode is selected by the pilot, while in DES mode. Furthermore, in HDG or TRK mode, only V/S or OP DES modes are available for descent.

To initiate a selected descent, the pilot should set the ATC cleared altitude on the FCU and pull the ALT selector. OP DES mode engages and is annunciated on the FMA. In OP DES mode, the A/THR commands THR IDLE and the speed is controlled by the THS.

Speed may be either managed or selected. In managed speed, the descent speed is displayed only as a magenta target but there is no longer a speed target range since the pre-computed flight profile does not apply.

The AP/FD will not consider any MCDU descent altitude constraints and will fly an unrestricted descent down to the FCU selected altitude.

If the crew wishes to steep the descent down, OP DES mode can be used, selecting a higher speed. Speedbrake is very effective in increasing descent rate but should be used with caution at high altitude due to the associated increase in VLS.

	<b>NORMAL OPERATIONS</b>	02.080
	DESCENT	JAN 09/07

If the pilot wishes to shallow the descent path, V/S can be used. A/THR reverts to SPEED mode. In this configuration, the use of speedbrakes is not recommended to reduce speed, since this would lead to thrust increase and the speed would be maintained.

### MODE REVERSION

MSN 0002-0860

R (2)

If a high V/S target is selected (or typically after a DES to V/S reversion), the autopilot will pitch the aircraft down to fly the target V/S. Thus the aircraft will tend to accelerate, while A/THR commands idle thrust to try to keep the speed. When IAS will reach a speed close to VMO or VFE, the autopilot will pitch the aircraft up, so as to fly a V/S allowing VMO or VFE to be maintained with idle thrust.

Triple click will be triggered.

### DESCENT CONSTRAINTS

R MSN 0002-0860

Descent constraints may be automatically included in the route as part of an arrival procedure or they may be manually entered through the MCDU F-PLN page. The aircraft will attempt to meet these as long as DES mode is being used.

The crew should be aware that an ATC "DIR TO" clearance automatically removes the requirement to comply with the speed/altitude constraints assigned to the waypoints deleted from the F-PLN. However, if intermediate waypoints are relevant, e.g. for terrain awareness, then "DIR TO" with ABEAMS may be an appropriate selection as constraints can be re-entered into these waypoints if required.

Following the selection of HDG, DES mode will switch automatically to V/S, and altitude constraints will no longer be taken into account.

**10.000 FT FLOW PATTERN**

R MSN 0002-0860

10.000 FT FLOW PATTERN

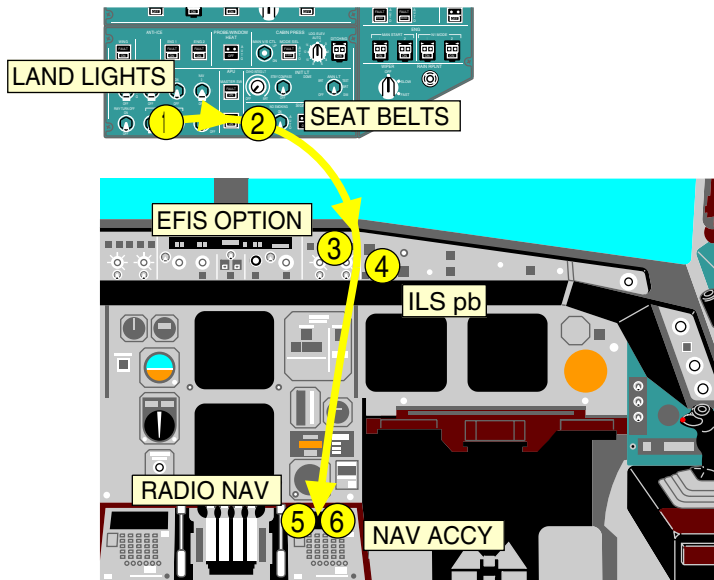

FOF 02080 03896 0001



	NORMAL OPERATIONS DESCENT	02.080
		JAN 09/07

**HIGHLIGHTS**

- (1) Correction of printing error.
- (2) New item 'MODE REVERSION' for 'MSN 0002-0860'

	<b>NORMAL OPERATIONS</b>	02.090
	HOLDING	JAN 09/07

## PREFACE

R MSN 0002-0860

Whenever holding is anticipated, it is preferable to maintain cruise level and reduce speed to green dot, with ATC clearance, to minimize the holding requirement. As a rule of thumb, a 0.05 Mach decrease during one hour equates to 4 minutes hold. However, other operational constraints might make this option inappropriate.

A holding pattern can be inserted at any point in the flight plan or may be included as part of the STAR. In either case, the holding pattern can be modified by the crew.

## HOLDING SPEED AND CONFIGURATION

R MSN 0002-0860

R (1)

If a hold is to be flown, provided NAV mode is engaged and the speed is managed, an automatic speed reduction will occur to achieve the Maximum Endurance speed when entering the holding pattern. The Maximum Endurance speed is approximately equal to Green Dot (it can be between Green Dot and Green Dot + 10 knots, depending on aircraft weight and flight conditions) and provides the lowest hourly fuel consumption.

If the Maximum Endurance speed is greater than the ICAO or state maximum holding speed, the crew should select flap 1 below 20,000 ft and fly S speed. Fuel consumption will be increased when holding in anything other than clean configuration and Maximum Endurance speed.

## IN THE HOLDING PATTERN

R MSN 0002-0860

The holding pattern is not included in the descent path computation since the FMGS does not know how many patterns will be flown. When the holding fix is

	<b>NORMAL OPERATIONS</b>  HOLDING	02.090
		JAN 09/07

sequenced, the FMGS assumes that only one holding pattern will be flown and updates predictions accordingly. Once in the holding pattern, the VDEV indicates the vertical deviation between current aircraft altitude and the altitude at which the aircraft should cross the exit fix in order to be on the descent profile.

The DES mode guides the aircraft down at 1000 fpm whilst in the holding pattern until reaching the cleared altitude or altitude constraint.

When in the holding pattern, LAST EXIT UTC/FUEL information is displayed on the MCDU HOLD page. These predictions are based upon the fuel policy requirements specified on the MCDU FUEL PRED page with no extra fuel, assuming the aircraft will divert. The crew should be aware that this information is computed with defined assumptions e.g.:

- . Aircraft weight being equal to landing weight at primary destination
- . Flight at FL 220 if distance to ALTN is less than 200 NM, otherwise FL 310 performed at maximum range speed
- . Constant wind (as entered in alternate field of the DES WIND page).
- . Constant delta ISA (equal to delta ISA at primary destination)
- . Airway distance for a company route, otherwise direct distance.

Alternate airport may be modified using the MCDU ALTN airport page which can be accessed by a lateral revision at destination.

To exit the holding pattern, the crew should select either:

- . IMM EXIT (The aircraft will return immediately to the hold fix, exit the holding pattern and resume its navigation) or
- . HDG if radar vectors or
- . DIR TO if cleared to a waypoint.

	<b>NORMAL OPERATIONS</b>  HOLDING	02.090
		JAN 09/07

**HIGHLIGHTS**

- (1) Harmonization with FCOM vol 4: a more precise information regarding the managed speed in holding is given.

**PREFACE**

R MSN 0002-0860

This section covers general information applicable to all approach types. Techniques, which apply to specific approach types, will be covered in dedicated chapters.

All approaches are divided into three parts (initial, intermediate and final) where various drills have to be achieved regardless of the approach type.

THE APPROACH PARTS AND ASSOCIATED ACTIONS

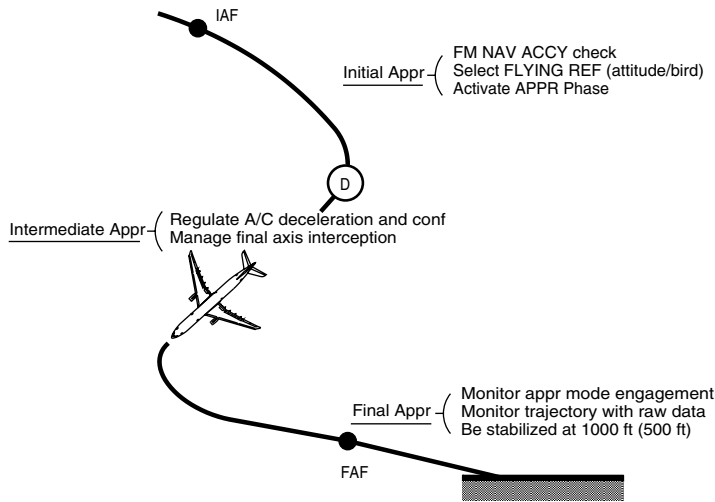

FOF 02100 03812 0001

**INITIAL APPROACH**

R MSN 0002-0860

NAVIGATION ACCURACY

	<b>NORMAL OPERATIONS</b>	02.100
	APPROACH GENERAL	JAN 09/07

Prior to any approach, a navigation accuracy check is to be carried out. On aircraft equipped with GPS however, no navigation accuracy check is required as long as GPS PRIMARY is available.

Without GPS PRIMARY or if no GPS is installed, navigation accuracy check has to be carried out. The navigation accuracy determines which AP modes the crew should use and the type of display to be shown on the ND.

### **THE FLYING REFERENCE**

It is recommended to use the FD bars for ILS approaches and the FPV called "bird" with FPD for non-precision or circling approach approaches.

### **APPROACH PHASE ACTIVATION**

Activation of the approach phase will initiate a deceleration towards VAPP or the speed constraint inserted at FAF, whichever applies.

When in NAV mode with managed speed, the approach phase activates automatically when sequencing the deceleration pseudo-waypoint . If an early deceleration is required, the approach phase can be activated on the MCDU PERF APPR page. When the approach phase is activated, the magenta target speed becomes VAPP.

When in HDG mode, e.g. for radar vectoring, the crew will activate the approach phase manually.

There are two approach techniques:

- . The decelerated approach
- . The stabilized approach

### **THE DECELERATED APPROACH**

This technique refers to an approach where the aircraft reaches 1000 ft in the landing configuration at VAPP. In most cases, this equates to the aircraft being in Conf 1 and at S speed at the FAF. This is the preferred technique for an ILS approach. The deceleration pseudo waypoint, D, assumes a decelerated approach technique.

### **THE STABILIZED APPROACH**

This technique refers to an approach where the aircraft reaches the FAF in the landing configuration at VAPP. This technique is recommended for non-precision approaches. To get a valuable deceleration pseudo waypoint and to ensure a timely deceleration, the pilot should enter VAPP as a speed constraint at the FAF.

**STABILIZED VERSUS DECELERATED APPROACH**

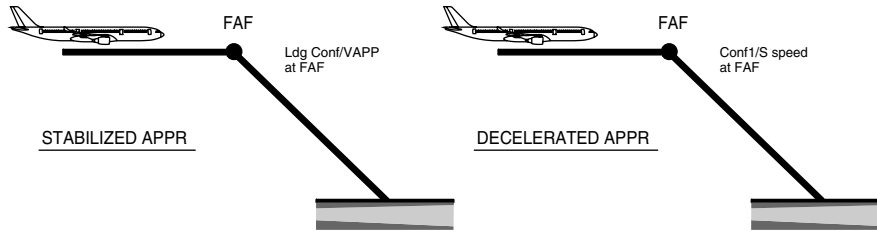

FOF 02100 03813 0001

**F-PLN SEQUENCING**

When in NAV mode, the F-PLN will sequence automatically. In HDG/TRK mode, the F-PLN waypoints will sequence automatically only if the aircraft flies close to the programmed route. Correct F-PLN sequencing is important to ensure that the programmed missed approach route is available in case of go-around. A good cue to monitor the proper F-PLN sequencing is the TO waypoint on the upper right side of the ND, which should remain meaningful.

If under radar vectors and automatic waypoint sequencing does not occur, the F-PLN will be sequenced by either using the DIR TO RADIAL IN function or by deleting the FROM WPT on the F-PLN page until the next likely WPT to be over flown is displayed as the TO WPT on the ND.

**INTERMEDIATE APPROACH**

R MSN 0002-0860

The purpose of the intermediate approach is to bring the aircraft at the proper speed, altitude and configuration at FAF.

**DECELERATION AND CONFIGURATION CHANGE**

Managed speed is recommended for the approach. Once the approach phase has been activated, the A/THR will guide aircraft speed towards the maneuvering speed of the current configuration, whenever higher than VAPP, e.g. green dot for Conf 0, S speed for Conf 1 etc.

	<b>NORMAL OPERATIONS</b>	02.100
	APPROACH GENERAL	JAN 09/07

To achieve a constant deceleration and to minimize thrust variation, the crew should extend the next configuration when reaching the next configuration maneuvering speed + 10 kts (IAS must be lower than VFE next), e.g. when the speed reaches green dot + 10 kts, the crew should select Conf 1. Using this technique, the mean deceleration rate will be approximately 10 kts/NM in level flight. This deceleration rate will be twice i.e. 20 kts/NM with the use of the speedbrakes.

If selected speed is to be used to comply with ATC, the requested speed should be selected on FCU. A speed below the manoeuvring speed of the present configuration may be selected provided it is above VLS. When the ATC speed constraint no longer applies, the pilot should push the FCU speed selector to resume managed speed.

When flying the intermediate approach in selected speed, the crew will activate the approach phase. This will ensure further proper speed deceleration when resuming managed speed; otherwise the aircraft will accelerate to the previous applicable descent phase speed.

In certain circumstances, e.g. tail wind or high weight, the deceleration rate may be insufficient. In this case, the landing gear may be lowered, preferably below 220 kts (to avoid gear doors overstress), and before selection of Flap 2. Speedbrakes can also be used to increase the deceleration rate but the crew should be aware of:

- . The increase in VLS with the use of speedbrakes
- . The limited effect at low speeds
- . The auto-retraction when selecting CONF 3 (A340 only) or CONF Full.

***Note:** Depending on PRIM standard, the speedbrakes can still be extended in CONF 3 (A340) and CONF FULL, but the F/CTL SPD BRK STILL OUT ECAM caution will be triggered.*

### **INTERCEPTION OF FINAL APPROACH COURSE**

To ensure a smooth interception of final approach course, the aircraft ground speed will be appropriate, depending upon interception angle and distance to runway threshold. The pilot will refer to applicable raw data (LOC, needles), XTK information on ND and wind component for the selection of an appropriate IAS.

If ATC provides radar vectors, the crew will use the DIR TO RADIAL IN facility. This ensures:

- . A proper F-PLN sequencing
- . A comprehensive ND display
- . An assistance for lateral interception



. The VDEV to be computed on reasonable distance assumptions.

However, considerations should be given the following:

. A radial is to be inserted in the MCDU. On the following example, the final approach course is 090° corresponding to radial 270°.

. Deceleration will not occur automatically as long as lateral mode is HDG

When established on the LOC, a DIR TO should not be performed to sequence the FPLN as this will result in the FMGS reverting to NAV mode. In this case, the LOC will have to be re-armed and re-captured, increasing workload unduly.

The final approach course interception in NAV mode is possible if GPS is PRIMARY or if the navigation accuracy check is positive.

USE OF DIR TO RADIAL IN FACILITY

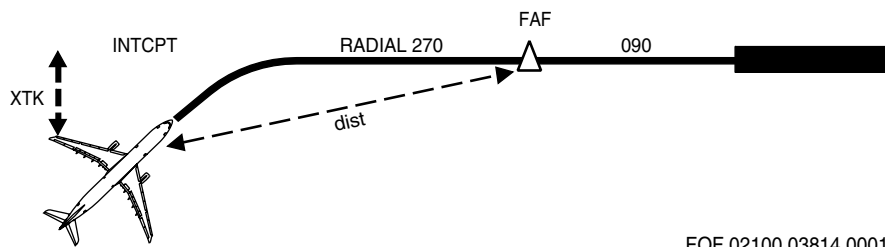

FOF 02100 03814 0001

If ATC gives a new wind for landing, the crew will update it on MCDU PERF APPR page.

Once cleared for the approach, the crew will press the APPR P/B to arm the approach modes when applicable.

**FINAL APPROACH**

R MSN 0002-0860

**FINAL APPROACH MODE ENGAGEMENT MONITORING**

The crew will monitor the engagement of G/S\* for ILS approach, FINAL for fully managed NPA or will select the Final Path Angle (FPA) reaching FAF for

	<b>NORMAL OPERATIONS</b>  APPROACH GENERAL	02.100
		JAN 09/07

selected NPA. If the capture or engagement is abnormal, the pilot will either use an appropriate selected mode or take over manually.

**FINAL APPROACH MONITORING**

The final approach is to be monitored through available data. Those data depends on the approach type and the result of the navigation accuracy check.

Approach type	Navigation accuracy check	Data to be monitored
ILS	-	LOC, GS deviation, DME and/or OM
Managed NPA	GPS primary	VDEV, XTK and F-PLN
Managed NPA	Non GPS PRIMARY	VDEV, XTK, Needles, DME and ALT
Selected NPA	Accuracy check negative	Needles, DME and ALT, Time

**SPEED CONSIDERATION**

**VAPP**

The approach speed (VAPP) is defined by the crew to perform the safest approach. It is function of gross weight, configuration, headwind, A/THR ON/OFF, icing and downburst.

R (1)

$$VAPP = VLS + \Delta$$

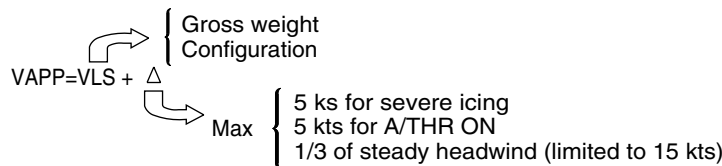

FOF 02100 03815 0001

In most cases, the FMGC provides valuable VAPP on MCDU PERF APPR page, once tower wind and FLAP 3 or FLAP FULL landing configuration has been inserted (VAPP = VLS + max of {5kt, 1/3 tower head wind component on landing RWY in the F-PLN}).

	<b>NORMAL OPERATIONS</b>	02.100
	APPROACH GENERAL	JAN 09/07

The crew can insert a lower VAPP on the MCDU APPR page, down to VLS, if landing is performed with A/THR OFF, with no wind, no downburst and no icing.

He can insert a higher VAPP in case of strong suspected downburst, but this increment is limited to 15 kts above VLS.

In case of strong or gusty crosswind greater than 20 knots, VAPP should be at least VLS +5 knots but this increment is limited to 15 knots above VLS.

The crew will bear in mind that the wind entered in MCDU PERF APPR page considers the wind direction to be in the same reference as the runway direction e. g. if airport if magnetic referenced, the crew will insert magnetic wind.

The wind direction provided by ATIS and tower is given in the same reference as the runway direction whereas the wind provided by VOLMET, METAR or TAF is always true referenced.

VAPP is computed at predicted landing weight while the aircraft is in CRZ or DES phase. Once the approach phase is activated, VAPP is computed using current gross weight.

Managed speed should be used for final approach as it provides Ground Speed mini (GS mini) guidance, even when the VAPP has been manually inserted.

## GROUND SPEED MINI

### PURPOSE

The purpose of the ground speed mini function is to keep the aircraft energy level above a minimum value, whatever the wind variations or gusts.

This allows an efficient management of the thrust in gusts or longitudinal shears. Thrust varies in the right sense, but in a smaller range ( $\pm 15\%$  N1) in gusty situations, which explains why it is recommended in such situations.

It provides additional but rational safety margins in shears.

It allows pilots "to understand what is going on" in perturbed approaches by monitoring the target speed magenta bugs: when target goes up = head wind gust.

### COMPUTATION

This minimum energy level is the energy the aircraft will have at landing with the expected tower wind; it is materialized by the ground speed of the aircraft at that time which is called GS mini:

GS mini = VAPP - Tower head wind component

	<b>NORMAL OPERATIONS</b>	02.100
	APPROACH GENERAL	JAN 09/07

In order to achieve that goal, the aircraft ground speed should never drop below GS mini in the approach, while the winds are changing. Thus the aircraft IAS must vary while flying down, in order to cope with the gusts or wind changes. In order to make this possible for the pilot or for the A/THR, the FMGS continuously computes an IAS target speed, which ensures that the aircraft ground speed is at least equal to GS mini; the FMGS uses the instantaneous wind component experienced by the aircraft:

IAS Target Speed = GS mini + Current headwind component

This target speed is limited by VFE-5 in case of very strong gusts, by VAPP in case of tailwind or if instantaneous wind is lower than the tower wind; below 400ft, the effect of the current wind variations is smoothly decreased so as to avoid too high speeds in the flare (1/3 of current wind variations taken into account).

VLS=130 kts  
Tower wind=20 kt Head wind  
➤  $V_{app}=130 + 1/3 HW$   
=137 kt  
➤  $GS\ mini=V_{app} - HW$   
=117 kt

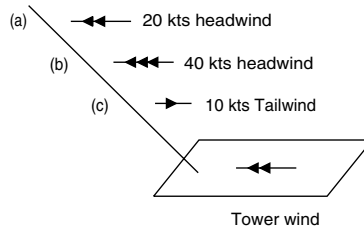

(a) Current wind = tower wind	(b) Head wind gust	(c) Tailwind gust
V <sub>app</sub> is the IAS target  Ground speed = GS mini	The IAS target increases  The IAS increases GS mini is maintained  Thrust slightly increases	The IAS target decreases (not below V <sub>app</sub> ) The IAS decreases GS increases  Thrust slightly decreases

FOF 02100 03816 0001

**USE OF A/THR**

The pilot should use the A/THR for approaches as it provides accurate speed control. The pilot will keep hand on the thrust levers so as to be prepared to

	<b>NORMAL OPERATIONS</b>	02.100
	APPROACH GENERAL	JAN 09/07

react if needed. If for any reason, the speed drops below VAPP significantly, the pilot will push the thrust levers forward above CLB detent (but below MCT) till the speed trend arrow indicates an acceleration then bring back the thrust levers into CLB detent. This is enough to be quickly back on speed.

USE OF A/THR FOR FINAL APPROACH

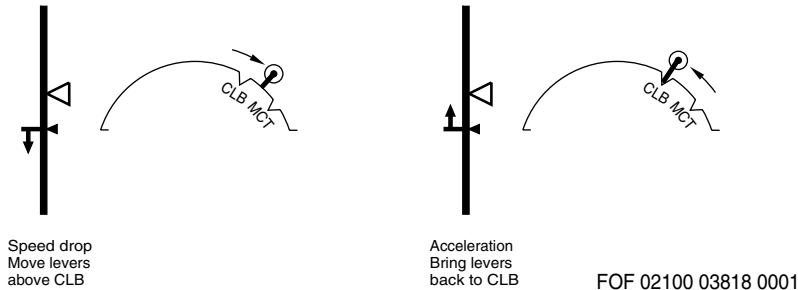

The pilot should keep in mind, however, that, when below 100 ft AGL, moving the thrust levers above the CLB detent will result in the A/THR disconnection.

During final approach, the managed target speed moves along the speed scale as a function of wind variation. The pilot should ideally check the reasonableness of the target speed by referring to GS on the top left on ND. If the A/THR performance is unsatisfactory, the pilot should disconnect it and control the thrust manually.

If the pilot is going to perform the landing using manual thrust, the A/THR should be disconnected by 1000 feet on the final approach.

**GO-AROUND ALTITUDE SETTING**

When established on final approach, the go-around altitude must be set on FCU. This can be done at any time when G/S or FINAL mode engages. However, on a selected Non Precision Approach, i.e. when either FPA or V/S is used, the missed approach altitude must only be set when the current aircraft altitude is below the missed approach altitude, in order to avoid unwanted ALT\*.

R (2) (3) (4)

**TRAJECTORY STABILIZATION**

The first prerequisite for safe final approach and landing is to stabilize the aircraft on the final approach flight path laterally and longitudinally, in landing configuration, at VAPP speed, i.e.:

	<b>NORMAL OPERATIONS</b>	02.100
	APPROACH GENERAL	JAN 09/07

- . Only small corrections are necessary to rectify minor deviations from stabilized conditions
- . The thrust is stabilized, usually above idle, to maintain the target approach speed along the desired final approach path

Airbus policy requires that stabilized conditions be reached at 1000 feet above airfield elevation in IMC and 500 feet above airfield elevation in VMC.

If, for any reason, one flight parameter deviates from stabilized conditions, the PNF will make a callout as stated below:

Exceedance and associated PNF callout				
Parameter		Exceedance		Callout
IAS		VAPP + 10kts / -5kts		"SPEED"
V/S		<-1000 ft/mn *		"SINK RATE"
Pitch attitude		+ 10 ° / 0 °		"PITCH"
Bank angle		7 °		"BANK"
<b>ILS only</b>	Localizer	Excess Deviation	1/4 dot PFD	"LOCALIZER"
	Glide slope		1 dot PFD	"GLIDE SLOPE"
NPAonly	Course	Excess deviation: 1/2 dot on PFD (or 2.5 deg. (VOR)/5 deg. (ADF))		"COURSE"
	Altitude at check points	Deviation		xFT HIGH (LOW)"

\*The V/S callout threshold becomes 1200 ft/mn for A340-500 and A340-600

Following a PNF flight parameter exceedance call out, the suitable PF response will be:

- . Acknowledge the PNF call out, for proper crew coordination purposes
- . Take immediate corrective action to control the exceeded parameter back into the defined stabilized conditions
- . Assess whether stabilized conditions will be recovered early enough prior to landing, otherwise initiate a go-around.

### **REACHING THE MINIMA**

Decision to land or go-around must be made at MDA/DH at the latest. Reaching the MDA/DH, at MINIMUM call out:

- . If suitable visual reference can be maintained and the aircraft is properly established, continue and land.

	<b>NORMAL OPERATIONS</b>	02.100
	APPROACH GENERAL	JAN 09/07

. If not, go-around.

The MDA/DH should not be set as target altitude on the FCU. If the MDA/DH were inserted on the FCU, this would cause a spurious ALT\* when approaching MDA/DH, resulting in the approach becoming destabilised at a critical stage.

R (5)

**AP DISCONNECTION**

During the final approach with the AP engaged, the aircraft will be stabilised . Therefore, when disconnecting the AP for a manual landing, the pilot should avoid the temptation to make large inputs on the sidestick.

The pilot should disconnect the autopilot early enough to resume manual control of the aircraft and to evaluate the drift before flare. During crosswind conditions, the pilot should avoid any tendency to drift downwind.

Some common errors include:

- . Descending below the final path, and/or
- . reducing the drift too early .



	<b>NORMAL OPERATIONS</b>	02.100
	APPROACH GENERAL	JAN 09/07

### HIGHLIGHTS

- (1) Additional recommendation, in case of strong or gusty crosswind
- (2) NPA taken into account in the call-out table
- (3) Table removed from 02.150 - PRECISION APPROACH to 02.100 - APPROACH GENERAL. This information is applicable to any kind of approach.
- (4) Additional information
- (5) Additional recommendation regarding the AP disconnection.

**PREFACE**

R MSN 0002-0860

This chapter deals with some characteristics of the ILS approach. Recommendations mentioned in APPROACH GENERAL chapter apply.

For CATI ILS, the crew will insert DA/DH values into MDA (or MDH if QFE function is available) field on MCDU PERF APPR page, since these values are baro referenced.

For CATII or CATIII ILS, the crew will insert DH into DH field on MCDU PERF APPR page, since this value is a radio altitude referenced.

**INITIAL APPROACH**

R MSN 0002-0860

**NAVIGATION ACCURACY**

When GPS PRIMARY is available, no NAV ACCURACY monitoring is required. When GPS PRIMARY is lost the crew will check on MCDU PROG page that the required navigation accuracy is appropriate. If NAV ACCURACY DOWNGRAD is displayed, the crew will use raw data for navigation accuracy check. The navigation accuracy determines which AP modes the crew should use and the type of display to be shown on the ND.

NAVIGATION ACCURACY	ND		AP/FD mode
	PF	PNF	
GPS PRIMARY NAV ACCUR HIGH NAV ACCUR LOW and NAV ACCURACY check $\leq 1$ NM	ARC or ROSE NAV with navaid raw data		NAV
GPS PRIMARY LOST and NAV ACCUR LOW and NAV ACCURACY check $> 1$ NM GPS PRIMARY LOST and Aircraft flying within unreliable radio navaid area	ROSE ILS	ARC or ROSE NAV or ROSE ILS with navaid raw data	HDG or TRK

	<b>NORMAL OPERATIONS</b>	02.110
	ILS APPROACH	JAN 09/07

### **FLYING REFERENCE**

The crew will select HDG V/S on the FCU i.e. "bird" off.

### **APPROACH PHASE ACTIVATION**

For a standard ILS, the crew should plan a decelerated approach. However, if the G/S angle is greater than 3.5° or if forecast tail wind at landing exceeds 10 kt (if permitted by AFM), a stabilized approach is recommended.

If FAF is at or below 2000 ft AGL and if deceleration is carried out using selected speed, the crew should plan a deceleration in order to be able to select conf 2 one dot below the G/S.

### **MISCELLANEOUS**

The LS PB is to be checked pressed in the first stage of the approach. The crew will check that:

- . LOC and GS scales and deviations are displayed on PFD
- . IDENT is properly displayed on the PFD. If no or wrong ident displayed, the crew will check the audio ident.

### **INTERMEDIATE APPROACH**

R MSN 0002-0860

### **INTERCEPTION OF FINAL APPROACH**

When cleared for the ILS, the APPR pb should be pressed. This arms the approach mode and LOC and GS are displayed in blue on the FMA. At this stage the second AP, if available, should be selected.

If the ATC clears for a LOC capture only, the crew will press LOC P/B on the FCU.

If the ATC clears for approach at a significant distance, e.g. 30 NM, the crew should be aware that the G/S may be perturbed and CAT 1 will be displayed on FMA till a valid Radio Altimeter signal is received.

	<b>NORMAL OPERATIONS</b>  ILS APPROACH	02.110
		JAN 09/07

**FINAL APPROACH**

R MSN 0002-0860

**GLIDE SLOPE INTERCEPTION FROM ABOVE**

The following procedure should only be applied when established on the localizer. There are a number of factors which might lead to a glide slope interception from above. In such a case, the crew must react without delay to ensure the aircraft is configured for landing before 1000 ft AAL. In order to get the best rate of descent when cleared by ATC and below the limiting speeds, the crew should lower the landing gear and select Conf 2. Speedbrakes may also be used, noting the considerations detailed in the sub-section "Deceleration and configuration change" earlier in this chapter. The recommended target speed for this procedure is VFE - 5 kts. When cleared to intercept the glide slope, the crew should:

- . Press the APPR PB on FCU and confirm G/S is armed.
- . Select the FCU altitude above aircraft altitude to avoid unwanted ALT\*.
- . Select V/S 1500 FPM initially. V/S in excess of 2000 FPM will result in the speed increasing towards VFE

**A/C HIGH ABOVE G/S - RECOMMENDED G/S CAPTURE TECHNIQUE**

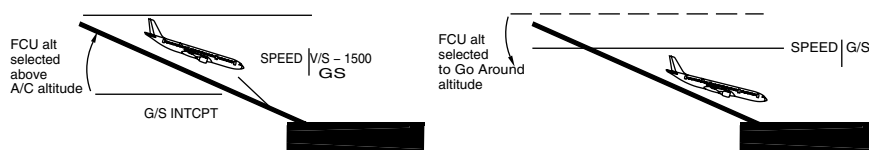

FOF 02110 03828 0001

It is vital to use V/S rather than OP DES to ensure that the A/THR is in speed mode rather than IDLE mode. The rate of descent will be carefully monitored to avoid exceeding VFE. When approaching the G/S, G/S\* will engage. The crew will monitor the capture with raw data (pitch and G/S deviation). The missed approach altitude will be set on the FCU and speed reduced so as to be configured for landing by 1000 ft.

	<b>NORMAL OPERATIONS</b>	02.110
	ILS APPROACH	JAN 09/07

In such a situation, taking into account the ground obstacles and if ATC permits, it may be appropriate to carry out a 360° turn before resuming the approach.

Close to the ground, avoid important down corrections. Give priority to attitude and sink rate. (See TAILSTRIKE AVOIDANCE in LANDING section).

### **MISCELLANEOUS**

In case of double receiver failure, the red LOC/GS flags are displayed, ILS scales are removed, the AP trips off and the FDs revert to HDG/VS mode.

In case of the ILS ground transmitter failure, the AP/FD with LOC/GS modes will remain ON. This is because such a failure is commonly transient. In such a case, ILS scales and FD bars are flashing. If R/A height is below 200 ft, the red AUTOLAND warning is triggered. If this failure lasts more than several seconds or in case of AUTOLAND red warning, the crew will interrupt the approach.

### **ILS RAW DATA**

R MSN 0002-0860

### **INITIAL APPROACH**

#### **FLYING REFERENCE**

The "bird" is to be used as the flying reference.

#### **APPROACH PHASE ACTIVATION**

The approach technique is the stabilized approach.

### **INTERMEDIATE APPROACH**

The TRK index will be set to the ILS course and, once established on the LOC, the tail of the bird should be coincident with the TRK index. This method allows accurate LOC tracking taking into account the drift.

Should the LOC deviate, the pilot will fly the bird in the direction of the LOC index, and when re-established on the LOC, set the tail of the bird on the TRK index again. If there is further LOC deviation, a slight IRS drift should be suspected. The bird is computed out of IRS data. Thus, it may be affected by

	<b>NORMAL OPERATIONS</b>	02.110
	ILS APPROACH	JAN 09/07

IRS data drift amongst other TRK. A typical TRK error at the end of the flight is 1° to 2°. The ILS course pointer and the TRK diamond are also displayed on PFD compass.

### **FINAL APPROACH**

When 1/2 dot below the G/S, the pilot should initiate the interception of the G/S by smoothly flying the FPV down to the glide path angle. The bird almost sitting on the -5° pitch scale on PFD, provides a -3° flight path angle. Should the G/S deviate, the pilot will make small corrections in the direction of the deviation and when re-established on the G/S, reset the bird to the G/S angle.

## PREFACE

R MSN 0002-0860

This chapter deals with some characteristics of the Non Precision Approach (NPA). Recommendations mentioned in APPROACH GENERAL chapter apply. NPA are defined as:

- . VOR approach
- . NDB approach
- . LOC, LOC-BC approach
- . R-NAV approach.

## APPROACH STRATEGY

R MSN 0002-0860

The overall strategy of NPA completion is to fly it "ILS alike" with the same mental image or representation and similar procedure. Instead of being referred to an ILS beam, the AP/FD guidance modes and associated monitoring data are referred to the FMS F-PLN consolidated by raw data. LOC only approach is the exception where LOC mode and localizer scale are to be used. This explains why the crew must ensure that the FMS data is correct, e.g. FMS accuracy, F-PLN (lateral and vertical) and proper leg sequencing.

The use of AP is recommended for all non-precision approaches as it reduces crew workload and facilitates monitoring the procedure and flight path.

## LIMITATIONS

R MSN 0002-0860

Lateral and vertical managed guidance (FINAL APP) can be used provided the following conditions are met:

- . The approach is defined in the navigation database

	<b>NORMAL OPERATIONS</b>  NON PRECISION APPROACH	02.120
		JAN 09/07

- . The approach has been crosschecked by the crew with the published procedure
- . The approach is approved by the operator for use of FINAL APP mode
- . The final approach is not modified by the crew.

**INITIAL APPROACH**

R MSN 0002-0860

**NAVIGATION ACCURACY**

The navigation accuracy check is most essential since it determines

- . The AP/FD guidance mode to be used
- . The ND display mode to be used
- . Which raw data which are to be used.

NAVIGATION ACCURACY	Approach guidance	ND		AP/FD mode
		PF	PNF	
GPS PRIMARY NAV ACCUR HIGH NAV ACCUR LOW and NAV ACCURACY check ≤1NM	Managed***	ARC or ROSE NAV* with navaid raw data		NAV-FPA or APP- NAV/FINAL ***
GPS PRIMARY LOST and NAV ACCUR LOW and NAV ACCURACY check > 1NM GPS PRIMARY LOST and aircraft flying within unreliable radio navaid area	Selected	ROSE VOR**	ARC or ROSE NAV or ROSE VOR** with navaid raw data	TRK-FPA

(\*) For VOR approach, one pilot may select ROSE VOR

(\*\*) For LOC approach, select ROSE ILS

(\*\*\*) The managed vertical guidance can be used provided the approach coding in the navigation database has been validated.



	<b>NORMAL OPERATIONS</b>	02.120
	NON PRECISION APPROACH	JAN 09/07

Should a NAV ACCY DNGRADED or a GPS PRIMARY LOST message is displayed during a managed non-precision approach, the crew should proceed as follow:

Message	VOR, ADF, VOR/DME approach	GPS approach
GPS PRIMRAY LOST	Cross-check the navigation accuracy: If positive, continue managed approach If negative, revert to selected approach with raw data.	Interrupt the approach
NAV ACCY DNGRADED		-

**FLYING REFERENCE**

The "bird" is to be used as the flying reference

**APPROACH PHASE ACTIVATION**

The stabilized approach technique is recommended. The crew will set VAPP as a speed constraint at FAF in order to get a meaningful deceleration pseudo waypoint.

**INTERMEDIATE APPROACH**

R MSN 0002-0860

**INTERCEPTION OF FINAL APPROACH COURSE**

It is essential to have a correct F-PLN in order to ensure proper final approach guidance. Indeed the NAV and APPR NAV modes are always guiding the aircraft along the F-PLN active leg and the managed vertical mode ensures VDEV =0, VDEV, being computed along the remaining F-PLN to destination. Hence, the crew will monitor the proper sequencing of the F-PLN, more specifically if HDG mode is selected, by checking that the TO WPT, on upper right hand corner of ND, is the most probable one and meaningful.

**F-PLN SEQUENCING IN APPROACH**

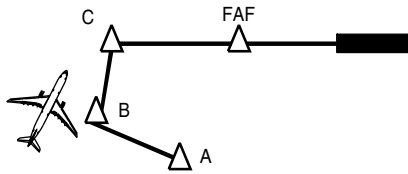

Radar vectors: pilot has not cleared A, B. A is still TO WPT – Hence no proper guidance available nor predictions.

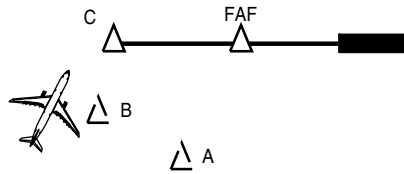

Radar vectors: pilot has monitored the TO WPT and cleared successively A and B when no longer probable. Hence VDEV is meaningful and APPR NAV or NAV may be armed.

FOF 02120 03836 0001

If ATC gives radar vectors for final approach course interception, the crew will use DIR TO FAF with RADIAL INBND facility. This creates an ILS alike beam which will be intercepted by NAV and APPR NAV modes. Additionally, the VDEV is realistic, XTK is related to the beam and the ND gives a comprehensive display.

**F-PLN SEQUENCING IN APPROACH**

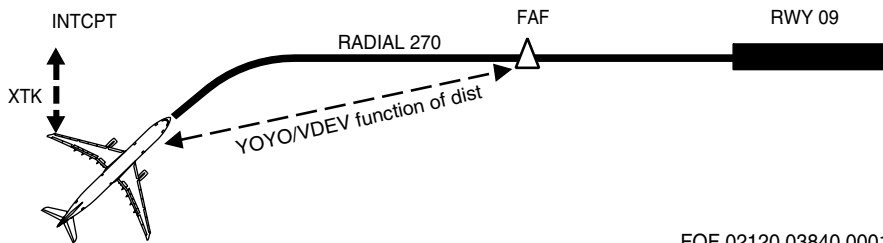

FOF 02120 03840 0001

When cleared for final approach course interception, the pilot will either:

- . Press APPR P/B on FCU if managed approach. On the FMA, APP NAV becomes active and FINAL becomes armed. The VDEV or "brick" scale becomes active and represents the vertical deviation, which may include a level segment. The VDEV/brick scale will only be displayed if LS pb is not pressed. If the LS pb is pressed by mistake, the V/DEV will flash in amber on the PFD or
- . Select adequate TRK on FCU, if selected approach, in order to establish final course tracking with reference to raw data. When established on the final course, the selected track will compensate for drift.

The final approach course interception will be monitored through applicable raw data.

	<b>NORMAL OPERATIONS</b>  NON PRECISION APPROACH	02.120
		JAN 09/07

**FINAL APPROACH**

R MSN 0002-0860

It is essential that the crew does not modify the final approach in the MCDU FPLN page.

The final approach will be flown either:

- . Managed or
- . Selected

**MANAGED**

For a managed approach, FINAL APP becomes active and the FM manages both lateral and vertical guidance. The crew will monitor the final approach using:

- . Start of descent blue symbol on ND
- . FMA on PFD
- . VDEV, XTK, F-PLN on ND with GPS PRIMARY
- . VDEV, XTK, F-PLN confirmed by needles, distance/altitude

If FINAL APPR does not engage at start of descent, the crew will select FPA convergent to the final path so as to fly with VDEV=0. Once VDEV=0, the crew may try to re-engage APPR.

In some NPAs, the final approach flies an "idle descent" segment from one altitude constraint to another, followed by a level segment. This is materialized by a magenta level off symbol on ND followed by a blue start of descent.

**FINAL APPROACH TRAJECTORY WITH IDLE DESCENT SEGMENT**

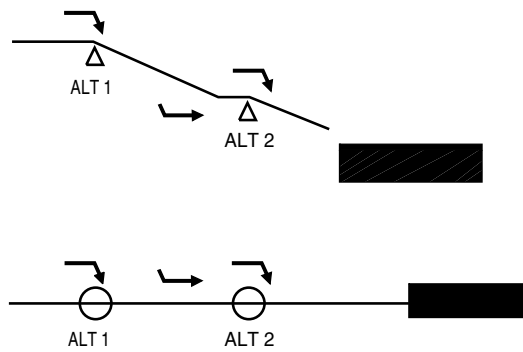

FOF 02120 03841 0001

**SELECTED**

For a selected approach, the Final Path Angle (FPA) should be preset on the FCU 1 NM prior to the FAF at the latest. A smooth interception of the final approach path can be achieved by pulling the FPA selector 0.2 NM prior to the FAF.

If GPS is PRIMARY, the crew will monitor VDEV, XTK and F-PLN. Additionally, for VOR or ADF approaches, the crew will monitor raw data.

**REACHING THE MINIMA**

R MSN 0002-0860

When approaching MDA, the pilot flying should expand the instrument scan to include outside visual cues.

Reaching MDA, "MINIMUM" is either monitored or called by the crew. The current altitude value becomes amber

- . If the required conditions are not met by MDA, a missed approach must be initiated.
- . If the required visual conditions are met to continue the approach, the AP must be disconnected, the FDs selected off, Bird ON and continue for visual approach.

	<b>NORMAL OPERATIONS</b>  <b>NON PRECISION APPROACH</b>	02.120
		JAN 09/07

R MSN 0002-0860

### **LOC ONLY APPROACH**

LOC ONLY approaches may be flown using the LOC signal for lateral navigation and FPA for vertical guidance. General recommendations mentioned above still apply. i.e. stabilized approach technique, use of the bird. Some additional recommendations need to be highlighted.

### **INITIAL APPROACH**

The crew will select LS P/B on the EIS control panel.

### **INTERMEDIATE APPROACH**

The crew will press LOC P/B on the FCU when cleared to intercept. He will monitor the LOC armed mode and then LOC capture.

### **FINAL APPROACH**

Approaching FAF, the crew will select FPA. When established on the final path, the crew will monitor:

- . Lateral displacement with LOC deviation
- . Vertical displacement with DME and ALT, "yoyo", time

### **LOC BACK COURSE APPROACH**

R MSN 0002-0860

LOC-BC approaches may be flown using the Bird with reference to the LOC-BC signal for lateral guidance and FPA for vertical guidance. General recommendations mentioned above still apply i.e. stabilized approach technique and use of the bird. Some additional recommendations need to be highlighted.

### **GENERAL**

The LOC-BC approach consists in using the LOC signal of the opposite runway for lateral approach management.

If the LOC-BC approach is stored in the FMS data base, it will be inserted into the F-PLN. The ILS frequency and associated back course are automatically tuned and displayed on the MCDU RAD NAV page. The CRS digit will be preceded by a "B".

If LOC-BC is not stored in the FMS data base, the crew will enter the ILS frequency and the final approach CRS the aircraft will actually fly preceded by a "B" in MCDU RAD NAV page. B/C in magenta will be displayed both on PFD and ND. This provides a proper directional deviation on PFD and a proper directional guidance from the FG.

LOC-BC APPROACH

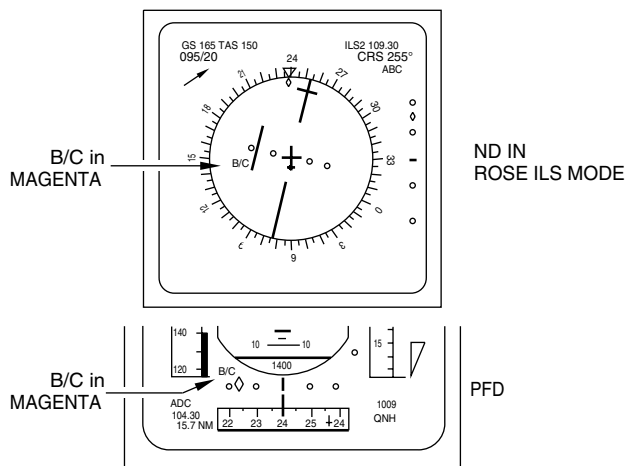
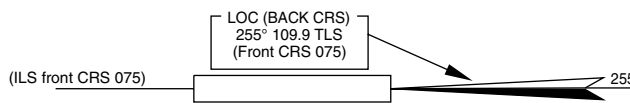

FOF 02120 03842 0001

	<b>NORMAL OPERATIONS</b>	02.120
	NON PRECISION APPROACH	JAN 09/07

### **INITIAL APPROACH**

The crew will select L/S P/B on the EIS control panel.

### **INTERMEDIATE APPROACH**

The crew will press LOC P/B on the FCU to arm LOC and will monitor LOC capture.

### **FINAL APPROACH**

Approaching the FAF, the crew will select the FPA corresponding to the final approach path, LOC deviation (proper directional guidance), DME/ALT, time, yoyo.

	<b>NORMAL OPERATIONS</b>	02.130
	CIRCLING APPROACH	JAN 09/07

## PREFACE

R MSN 0002-0860

The circling approach is flown when the tower wind is such that the landing runway is different from the runway fitted with an instrument approach, which is used for the descent and approach in order to get visual of the airfield.

## APPROACH PREPARATION

R MSN 0002-0860

The approach preparation follows the same schema as described in APPROACH PREPARATION section in CRUISE chapter. However, some characteristics need to be highlighted:

### **FPLN**

Lateral: STAR, instrument approach procedure.

Vertical: Insert F speed as constraint at FAF since the approach will be flown flaps 3, landing gear down and F speed (stabilized approach); Check altitude constraints.

### **RAD NAV**

Manually tune the VOR/DME of destination airfield as required.

### **PROG**

Insert VOR/DME of destination airfield in the BRG/DIST field as required.

Check NAV ACCY if required by comparing BRG/DIST data to raw data.

### **PERF**

PERF APPR: Descent winds, destination airfield weather, minima and landing flap selection (wind shear anticipated or in case of failure).

PERF GO AROUND: Check thrust reduction and acceleration altitude.



	<b>NORMAL OPERATIONS</b>	02.130
	<b>CIRCLING APPROACH</b>	JAN 09/07

### **FUEL PRED**

Check estimated landing weight and extra fuel.

### **SEC FPLN**

When planning for a circling approach, the landing runway will be inserted into the SEC F-PLN. The crew will update the SEC F-PLN as follows:

- . SEC F-PLN then COPY ACTIVE
- . Lateral revision on destination and insert landing runway
- . Keep the F-PLN discontinuity

### **FINAL INSTRUMENT APPROACH**

R MSN 0002-0860

The crew will fly a stabilized approach at F speed, configuration 3 and landing gear down.

### **CIRCLING APPROACH**

R MSN 0002-0860

R (1)

When reaching circling minima and with sufficient visual reference for circling:

- . Push the FCU ALT P/B.
- . Select TRK/FPA
- . Select a TRK of 45 ° away from the final approach course (or as required by the published procedure)
- . When wings level, start the chrono
- . Once established downwind, activate the SEC F-PLN to take credit of the "GS mini" protection in final approach when managed speed is used. Additionally,

the landing runway will be shown on the ND and the 10 NM range should be selected to assist in positioning onto final approach

- . By the end of the downwind leg, disconnect the AP, select both FDs off and keep the A/THR
- . When leaving the circling altitude, select the landing configuration
- . Once fully configured, complete the Landing Checklist.

Once the SEC F-PLN is activated, the go-around procedure in the MCDU will be that for the landing runway rather than the one associated with the instrument approach just carried out. Therefore, if visual references were lost during the circling approach, the go-around would have to be flown using selected guidance, following the pre-briefed missed approach procedure.

For circling approach with one engine inoperative, refer to FCTM 03.020.

**LOW VISIBILITY CIRCLING APPROACH**

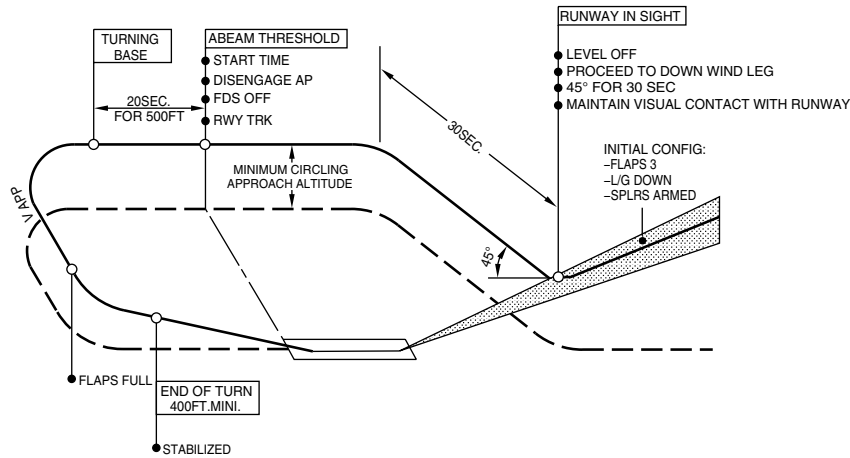

FOF 02130 03845 0001

	<b>NORMAL OPERATIONS</b>	02.130
	CIRCLING APPROACH	JAN 09/07

**HIGHLIGHTS**

- (1) Harmonization of recommendation with the pattern: the FDs are kept ON until AP disconnection.

	<b>NORMAL OPERATIONS</b>	02.140
	VISUAL APPROACH	JAN 09/07

### INITIAL APPROACH

R MSN 0002-0860

The crew must keep in mind that the pattern is flown visually. However, the XTK is a good cue of the aircraft lateral position versus the runway centreline. This is obtained when pressing DIR TO CF RADIAL IN.

The crew will aim to get the following configuration on commencement of the downwind leg:

- . Both AP and FDs will be selected off
- . BIRD ON
- . A/THR confirmed active in speed mode, i.e. SPEED on the FMA
- . Managed speed will be used to enable the "GS mini" function
- . The downwind track will be selected on the FCU to assist in downwind tracking
- . The down wind track altitude will be set on FCU.

### INTERMEDIATE/FINAL APPROACH

R MSN 0002-0860

Assuming a 1500 ft AAL circuit, the base turn should be commenced 45 seconds after passing abeam the downwind threshold (+/- 1 second/kt of head/tailwind). The final turn onto the runway centreline will be commenced with 20° angle of bank. Initially the rate of descent should be 400 fpm, increasing to 700 fpm when established on the correct descent path.

The pilot will aim to be configured for landing at VAPP by 500 ft AAL, at the latest. If not stabilised, a go-around must be carried out.

R (1)

### VISUAL APPROACH

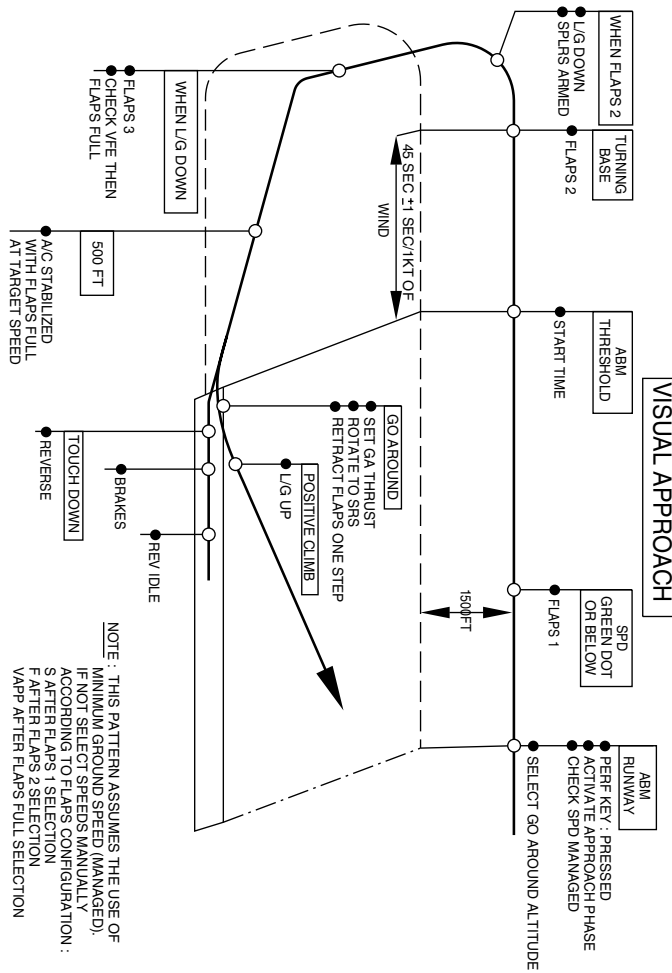

FOF 02140 00001 0001

R (2)

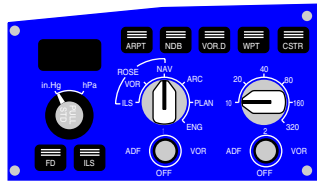

FOF 02140 03846 0001

	<b>NORMAL OPERATIONS</b>	02.140
	VISUAL APPROACH	JAN 09/07

**HIGHLIGHTS**

- (1) Pattern increased for better legibility
- (2) New item " for 'MSN 0002-0860'

	<b>NORMAL OPERATIONS</b>	02.150
	<b>PRECISION APPROACH</b>	JAN 09/07

## GENERAL

R MSN 0002-0860

CAT II and CAT III approaches are flown to very low DH (or without DH) with very low RVR. The guidance of the aircraft on the ILS beam and the guidance of the aircraft speed must be consistently of high performance and accurate so that an automatic landing and roll out can be performed in good conditions and, the acquisition of visual cues is achieved the aircraft properly stabilized. Hence,

- . The automatic landing is required in CAT III operations including roll out in CAT IIIB.
- . The automatic landing is the preferred landing technique in CATII conditions
- . Any failures of the automated systems shall not significantly affect the aircraft automatic landing system performance
- . The crew procedures and task sharing allow to rapidly detect any anomaly and thus lead to the right decision

## DEFINITION

R MSN 0002-0860

### **DECISION HEIGHT**

The Decision Height (DH) is the wheel height above the runway elevation by which a go around must be initiated unless adequate visual reference has been established and the aircraft position and the approach path have been assessed as satisfactory to continue the automatic approach and landing in safety. The DH is based on RA.

### **ALERT HEIGHT**

The Alert Height (AH) is the height above the runway, based on the characteristics of the aeroplane and its fail-operational automatic landing system, above which a CAT III approach would be discontinued and a missed approach initiated if a failure occurred in one of the redundant part of the automatic landing system, or in the relevant ground equipment.



	<b>NORMAL OPERATIONS</b>	02.150
	<b>PRECISION APPROACH</b>	JAN 09/07

In others AH definition, it is generally stated that if a failure affecting the fail-operational criteria occurs below the AH, it would be ignored and the approach continued (except if AUTOLAND warning is triggered). The AH concept is relevant when CAT3 DUAL is displayed on FMA.

For the A330 and A340, the AH =200 ft.

**CAT 3 SINGLE**

CAT 3 SINGLE is announced when the airborne systems are fail passive which means that a single failure will lead to the AP disconnection without any significant out of trim condition or deviation of the flight path or attitude. Manual flight is then required. This minimum DH is 50ft.

**CAT 3 DUAL**

CAT 3 DUAL is announced when the airborne systems are fail-operational. In case of a single failure, the AP will continue to guide the aircraft on the flight path and the automatic landing system will operate as a fail-passive system. In the event of a failure below the AH, the approach, flare and landing can be completed by the remaining part of the automatic system. In that case, no capability degradation is indicated. Such a redundancy allows CAT III operations with or without DH.

**CAT II OR CAT III APPROACHES**

		ICAO	FAA	JAA
CAT II	DH	100ft≤DH<200ft	100ft≤DH<200ft	100ft≤DH<200ft
	RVR	RVR ≥350 m RVR≥1200ft	350m≤RVR<800m 1200ft≤RVR<2400ft	RVR>≥300m RVR≥1000 ft
CAT IIIA	DH	No DH or DH<100ft	No DH or DH<100ft	DH<100 ft
	RVR	RVR ≥200 m RVR≥ 700ft	RVR ≥200 m RVR≥ 700ft	RVR ≥200 m RVR≥ 700ft
CAT IIIB	DH	No DH or DH<50 ft	No DH or DH<50 ft	No DH or DH<50 ft
	RVR	50m≤RVR<200m 150ft≤RVR<700ft	50m≤RVR<200m 150ft≤RVR<700ft	75m≤RVR<200m 250ft≤RVR<700ft

(1) DH≥50 ft if fail passive

**FLIGHT PREPARATION**

	<b>NORMAL OPERATIONS</b>	02.150
	<b>PRECISION APPROACH</b>	JAN 09/07

R MSN 0002-0860

In addition to the normal flight preparation, the following preparation must be performed when CAT II or CAT III approach is planned:

- . Ensure that destination airport meets CATII or CATIII requirements
- . Check aircraft required equipment for CAT II or CAT III in QRH
- . Check that crew qualification is current
- . Consider extra fuel for possible approach delay
- . Consider weather at alternate

### APPROACH PREPARATION

R MSN 0002-0860

#### **LIMITATIONS**

- . The crew will check that tower wind remains within the limit for CAT II or CAT III approaches (See limitations chapter in FCOM3)
- . The autoland maximum altitude must be observed.

#### **AIRCRAFT CAPABILITY**

The failures that may affect the aircraft's CAT 2/3 capability are listed in the QRH. Most of these failures are monitored by the FMGS and the landing capability will be displayed on the FMA once the APPR pb is pressed, i.e. CAT 2, CAT 3 SINGLE, CAT 3 DUAL. However, there are a number of failures which affect the aircraft's landing capability which are not monitored by the FMGS and, consequently, not reflected on the FMA. It is very important, therefore, that the crew refer to the QRH to establish the actual landing capability if some equipment are listed inoperative.

#### **AIRPORT FACILITIES**

The airport authorities are responsible for establishing and maintaining the equipment required for CAT II/III approach and landing. The airport authorities will

	<b>NORMAL OPERATIONS</b>	02.150
	<b>PRECISION APPROACH</b>	JAN 09/07

activate the LVP procedures as the need arises based on RVR. The airport authorities will activate the LVP procedures as the need arises based on RVR. Prior performing a CAT II/III approach, the crew must ensure that LVP procedures are in force.

**CREW QUALIFICATION**

The captain must ensure that both crew members are qualified and that their qualification is current for the planned approach.

**SEATING POSITION**

The crew must realise the importance of eye position during low visibility approaches and landing. A too low seat position may greatly reduce the visual segment. When the eye reference position is lower than intended, the visual segment is further reduced by the cut-off angle of the glareshield or nose. As a rule of thumb, an incorrect seating position which reduces the cut-off angle by 1° reduces the visual segment by approximately 10m (30 ft).

**USE OF LANDING LIGHTS**

The use of landing lights at night in low visibility can be detrimental to the acquisition of visual reference. Reflected lights from water droplets or snow may actually reduce visibility. The landing lights would, therefore, not normally be used in CAT II/III weather conditions.

**APPROACH STRATEGY**

Irrespective of the actual weather conditions, the crew should plan the approach using the best approach capability. This would normally be CAT 3 DUAL with autoland, depending upon aircraft status. The crew should then assess the weather with respect to possible downgrade capability.

Conditions	CATI	CATII	CATIII	
			WITH DH	NO DH
Flying technique	Hand flying or AP/FD, A/THR	AP/FD, A/THR down to DH	AP/FD/ATHR and Autoland	
Minima & weather	DA (DH) Baro ref Visibility		DH with RA RVR	
Autoland	Possible with precautions	Recommended	Mandatory	

	<b>NORMAL OPERATIONS</b>	02.150
	<b>PRECISION APPROACH</b>	JAN 09/07

### **GO AROUND STRATEGY**

The crew must be ready mentally for go-around at any stage of the approach. Should a failure occur above 1000 ft RA, all ECAM actions (and DH amendment if required) should be completed before reaching 1000 ft RA, otherwise a go-around should be initiated. This ensures proper task sharing for the remainder of the approach. Any alert generated below 1000 ft should lead to a go-around.

### **APPROACH BRIEFING**

Before commencing a CAT II/III approach a number of factors must be considered by the crew. In addition to the standard approach briefing, the following points should be emphasised during an approach briefing for a low visibility approach:

- . Aircraft capability
- . Airport facilities
- . Crew qualification
- . Weather minima
- . Task sharing
- . Call-outs
- . Go-around strategy

### **APPROACH PROCEDURE**

R MSN 0002-0860

R (1) (2)

#### **TASK SHARING**

The workload is distributed in such a way that the PF primary tasks are supervising and decision making and the PNF primary task is monitoring the operation of the automatic system.

The PF supervises the approach (trajectory, attitude, speed) and takes appropriate decision in case of failure and at DH. Since the approach is flown with AP/FD/A-THR, the PF must be continuously ready to take-over:

- . If any AP hard over is experienced

	<b>NORMAL OPERATIONS</b>	02.150
	<b>PRECISION APPROACH</b>	JAN 09/07

- . If a major failure occurs.
- . If any doubt arises

The PF announces "LAND", when displayed on FMA.

The PNF is head down throughout the approach and landing. The PNF monitors:

- . The FMA and calls mode change as required (except "LAND")
- . The Auto call out
- . The aircraft trajectory or attitude exceedance
- . Any failures

The PNF should be go-around minded.

### **SOME SYSTEM PARTICULARS**

- . Below 700 ft RA, data coming from the FMS are frozen e.g. ILS tune inhibit.
- . Below 400 ft RA, the FCU is frozen.
- . At 350 ft, LAND must be displayed on FMA. This ensures correct final approach guidance.
- . Below 200 ft, the AUTOLAND red light illuminates if
  - Both APs trip off
  - Excessive beam deviation is sensed
  - Localizer or glide slope transmitter or receiver fails
  - A RA discrepancy of at least 15 feet is sensed.
- . Flare comes at or below 40ft
- . THR IDLE comes at or below 30ft
- . RETARD auto call out comes at 10ft for autoland as an order. (Instead of 20 ft for manual landing as an indication)

### **VISUAL REFERENCE**

Approaching the DH, the PF starts to look for visual references, progressively increasing external scanning. It should be stressed that the DH is the lower limit of the decision zone. The captain should come to this zone prepared for a go-around but with no pre-established judgement.

Required conditions to continue

- . With DH
  - In CATII operations, the conditions required at DH to continue the approach are that the visual references should be adequate to monitor the continued approach and landing and that the flight path should be acceptable. If both

these conditions are not satisfied, it is mandatory to initiate a go-around. A 3 lights segment and a lateral light element is the minimum visual cue for JAR OPS.

In CATIII operations, the condition required at DH is that there should be visual references which confirm that the aircraft is over the touch down zone. Go-around is mandatory if the visual references do not confirm this. A 3 lights segment is required by JAR OPS for fail passive system and 1 centerline light segment for fail operational system.

. Without DH

The decision to continue does not depend on visual references, even though a minimum RVR is specified. The decision depends only on the operational status of the aircraft and ground equipment. If a failure occurs prior to reaching the AH, a go-around will be initiated. A go-around must nevertheless be performed if AUTOLAND warning is triggered below AH. However, it is good airmanship for the PF to acquire visual cues during flare and to monitor the roll out.

Loss of visual reference

. With DH before touch down

If decision to continue has been made by DH and the visual references subsequently become insufficient a go-around must be initiated.

A late go-around may result in ground contact. If touch down occurs after TOGA is engaged, the AP remains engaged in that mode and A/THR remains in TOGA. The ground spoilers and auto-brake are inhibited.

. With DH or without DH after touch down

If visual references are lost after touch down, a go-around should not be attempted. The roll-out should be continued with AP in ROLL OUT mode down to taxi speed.

### **FLARE/LANDING/ROLL OUT**

During the flare, decrab and roll-out, the PF will watch outside to assess that the autoland is properly carried out, considering the available visual references.

For CATII approaches, autoland is recommended. If manual landing is preferred, the PF will take-over at 80 ft at the latest. This ensures a smooth transition for the manual landing.

Pull to reverse IDLE at main landing gear touchdown (not before). When REV is indicated in green on ECAM, MAX reverse may be applied. The use of auto-brake is recommended as it ensures a symmetrical brake pressure application. However, the crew should be aware of possible dissymmetry in case of crosswind and wet runways.

The PNF will use standard call out. Additionally, he will advise ATC when aircraft is properly controlled (speed and lateral trajectory).

	<b>NORMAL OPERATIONS</b>	02.150
	<b>PRECISION APPROACH</b>	JAN 09/07

**FAILURE AND ASSOCIATED ACTIONS**

R MSN 0002-0860

As a general rule, if a failure occurs above 1000 ft AGL, the approach may be continued, ECAM actions completed, approach briefing update performed and a higher DH set if required.

Below 1000ft (and down to AH in CAT3 DUAL), the occurrence of any failure implies a go-around and a reassessment of the system capability. Another approach may be under taken according to the new system capability. It has been considered that below 1000 ft, not enough time is available for the crew to perform the necessary switching, to check system configuration and limitation and brief for minima.

In CAT3 DUAL and below AH, as a general rule, a single failure does not necessitate a go-around. A go-around is required if the AUTOLAND warning is triggered.

**AUTOLAND IN CAT 1 OR BETTER WEATHER CONDITIONS**

R MSN 0002-0860

The crew may wish to practice automatic landings in CAT1 or better weather conditions for training purposes. This type of approach should be carried out only with the airline authorization. The crew should be aware that fluctuations of the LOC and/or GS might occur due to the fact that protection of ILS sensitive areas, which applies during LVP, will not necessarily be in force. It is essential, therefore, that the PF is prepared to take over manually at any time during a practice approach and rollout, should the performance of the AP become unsatisfactory.

	NORMAL OPERATIONS	02.150
	PRECISION APPROACH	JAN 09/07

### HIGHLIGHTS

- (1) Harmonization of call out with general Airbus training policy.
- (2) Information removed from 02.150 - PRECISION APPROACH to 02.100 - APPROACH GENERAL. This information is applicable to any kind of approach.



	<b>NORMAL OPERATIONS</b>	02.160
	LANDING	JAN 09/07

## PREFACE

R MSN 0002-0860

When Transitioning from IMC to VMC, the crew will watch the bird versus the aircraft attitude symbol in the center of the PFD. This provides a good assessment of the drift, thus in which direction to look for the runway.

But, then

- . Do not turn towards the runway
- . Do not duck under

## MAIN GEAR CLEARANCE

R MSN 0002-0860

On the Airbus 330/340 aircraft, the pilot eye to wheel height on approach is 34 ft and the minimum wheel clearance over threshold is 20 ft. The boxed images below are the one to retain on A330/A340 to provide a proper wheel clearance at threshold.

### USE OF VASI / TVASI

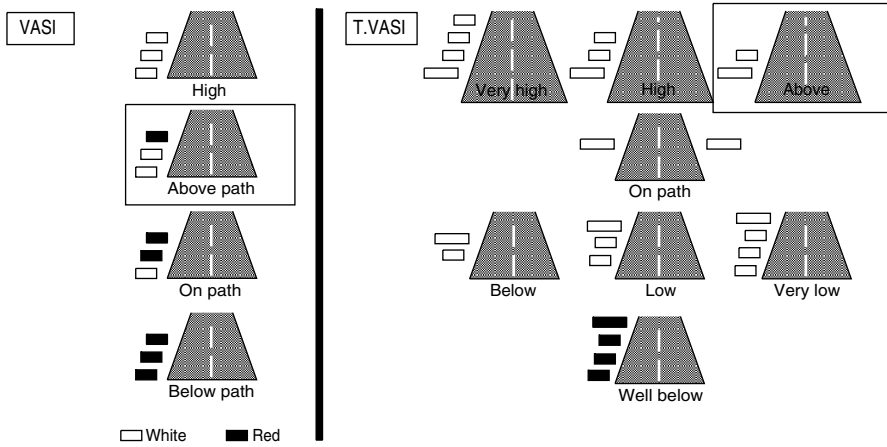

FOF 02160 03833 0001

USE OF PAPI

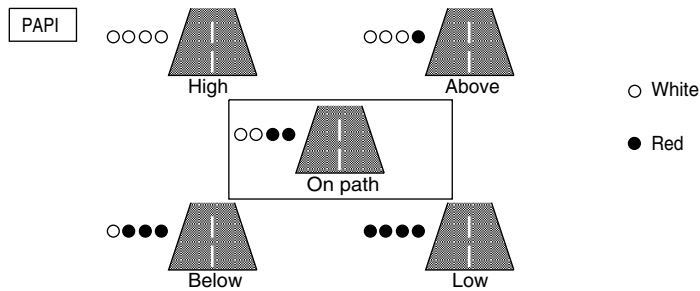

FOF 02160 03834 0001

This technique will ensure that performance margins are not compromised and provide adequate main gear clearance.

	<b>NORMAL OPERATIONS</b>	02.160
	<b>LANDING</b>	JAN 09/07

## FLARE

R MSN 0002-0860

R (1)

### **PITCH CONTROL**

When reaching 100 ft, auto-trim ceases and the pitch law is modified to be a full authority direct law as described in OPERATIONAL PHILOSOPHY Chapter. Indeed, the normal pitch law, which provides trajectory stability, would not be well adapted to the flare manoeuvre. Consequently, in the flare, as the speed reduces, the pilot will have to move the stick rearwards to maintain a constant path. The flare technique is thus very conventional. From stabilized conditions, the flare height is about 40 ft. This height varies with different parameters, such as weight, rate of descent, wind variations ...

Avoid under flaring.

- . The rate of descent must be controlled prior to the initiation of the flare (i.e. nominal 3° slope and rate not increasing)
- . Start the flare with positive backpressure on the sidestick and holding as necessary
- . Avoid significant forward stick movement once Flare initiated (releasing back-pressure is acceptable)

At 20 ft, the "RETARD" auto call-out reminds the pilot to retard thrust levers. It is a reminder rather than an order. The pilot will retard the thrust levers when best adapted e.g. if high and fast on the final path the pilot will retard earlier.

In order to assess the rate of descent in the flare, and the aircraft position relative to the ground, look well ahead of the aircraft. The typical pitch increment in the flare is approximately 4°, which leads to 1° flight path angle associated with a 10 kt speed decay in the manoeuvre. A prolonged float will increase both the landing distance and the risk of tail strike.

### **LATERAL AND DIRECTIONAL CONTROL**

#### **FINAL APPROACH**

In crosswind conditions, a crabbed-approach should be flown.

	<b>NORMAL OPERATIONS</b>  <b>LANDING</b>	02.160
		JAN 09/07

**FLARE**

The objectives of the lateral and directional control of the aircraft during the flare are:

- . To land on the centerline
- . And, to minimize the loads on the main landing gear.

During the flare, rudder should be applied as required to align the aircraft with the runway heading. Any tendency to drift downwind should be counteracted by an appropriate input on the sidestick.

In the case of a very strong cross wind, the aircraft may be landed with a residual drift (maximum 5°) to prevent an excessive bank (maximum 5°). Consequently, combination of the partial de-crab and wing down techniques may be required.

R MSN 0012 0017 0030 0037 0045 0050 0054-0055 0059-0060 0062 0064-0073 0077  
0082-0083 0086-0087 0095-0096 0098-0100 0102 0106-0113 0116 0118-0122 0127 0132 0138  
0140 0143-0144 0148 0153 0155 0162 0165 0171-0172 0177 0181 0183-0184 0188-0189  
0191 0195 0198 0200 0203 0205-0206 0209 0211 0219 0222-0224 0226 0229-0232 0234  
0238 0240-0241 0244 0247-0251 0253-0256 0258-0259 0261-0262 0265-0267 0269 0271-0272  
0275-0277 0279 0281 0283-0291 0293-0296 0299-0301 0303 0305-0306 0308-0309 0311-0317  
0320 0322-0324 0326 0328 0330 0333-0334 0337-0346 0348-0351 0353 0356-0358 0361-0362  
0364-0366 0368-0370 0372 0375 0380 0382 0384 0386 0388-0389 0392-0393 0396-0398  
0400-0401 0403-0405 0407-0409 0412 0418-0423 0425 0427-0428 0432 0437 0439 0441  
0443-0444 0448 0451-0452 0454-0456 0458 0461-0463 0465-0466 0469 0472-0473 0476-0477  
0479-0481 0484 0486-0487 0489-0491 0493-0494 0496-0498 0500-0513 0515-0516 0518-0519  
0521-0522 0524-0527 0529-0530 0532-0533 0535-0536 0539 0542 0548-0553 0555 0558  
0564-0565 0567-0568 0570-0571 0573-0574 0576 0578-0579 0581 0584 0587-0588 0591-0597  
0600 0602-0603 0605 0607 0609-0610 0612-0614 0616 0618 0620-0621 0623 0625 0627  
0629 0631-0638 0640-0642 0644-0645 0647-0650 0652-0667 0669-0671 0673-0676 0678-0680  
0682-0684 0686-0688 0690-0693 0695-0697 0699-0701 0703-0705 0707-0709 0711-0714  
0716-0718 0720-0722 0724-0726 0728-0730 0732-0735 0737-0739 0741-0743 0745-0747  
0749-0752 0754-0756 0758-0760 0769-0770 0772-0774 0776-0778 0780-0782 0784-0786  
0788-0789 0791-0792 0795-0797 0799 0801-0803 0805-0811 0813-0828 0830-0834 0836  
0838-0843 0845 0847 0849-0860

**MAXIMUM DEMONSTRATED CROSSWIND FOR LANDING**

Reported braking action	Reported runway friction coefficient	Maximum demonstrated crosswind for landing (kt)	Maximum demonstrated crosswind for landing (kt)
-------------------------	--------------------------------------	-------------------------------------------------	-------------------------------------------------

	<b>NORMAL OPERATIONS</b>	02.160
	LANDING	JAN 09/07

Good	$\geq 0.4$	32	Dry, damp, wet
------	------------	----	----------------

R MSN 0002-0011 0013-0016 0018-0029 0031-0035 0038-0044 0046-0049 0051-0053 0056-0058  
0061 0063 0074-0076 0078-0081 0084-0085 0088-0094 0097 0101 0103-0104 0114-0115 0117  
0123-0126 0128-0131 0133-0137 0139 0141-0142 0145-0147 0149-0152 0154 0156-0161  
0163-0164 0166-0170 0173-0176 0178-0180 0182 0185-0187 0190 0192-0194 0196-0197 0199  
0201-0202 0204 0207-0208 0210 0212-0218 0220-0221 0225 0227-0228 0233 0235-0237  
0239 0242-0243 0245-0246 0252 0257 0260 0263-0264 0268 0270 0273-0274 0278 0280  
0282 0292 0297 0302 0304 0307 0310 0318-0319 0321 0325 0327 0329 0331-0332 0335  
0347 0352 0354-0355 0359 0363 0367 0373-0374 0377-0379 0381 0385 0387 0390 0395  
0399 0402 0406 0411 0413-0415 0424 0429-0430 0433-0435 0438 0442 0446-0447 0450  
0459 0467 0470 0474 0483 0528 0538 0541 0544-0546 0554 0556 0559 0561-0562 0582  
0585 0590 0598 0643 0646 0651 0668 0793 0800 0835 0844

**MAXIMUM DEMONSTRATED CROSSWIND FOR LANDING**

Reported braking action	Reported runway friction coefficient	Maximum demonstrated crosswind for landing (kt)	Equivalent runway condition
Good	$\geq 0.4$	27	Dry, damp, wet

R MSN 0394 0445 0457 0464 0471 0478 0485 0492 0495 0499 0520 0560 0563 0572 0608  
0611 0624 0628 0685 0694 0698 0748 0757 0761 0775 0783

**MAXIMUM DEMONSTRATED CROSSWIND FOR LANDING**

Reported braking action	Reported runway friction coefficient	Maximum demonstrated crosswind for landing	Equivalent runway condition
Good	$\geq 0.4$	37 kt	Dry, damp, wet

**CALL OUT**

R MSN 0002-0003 0005 0007 0012-0013 0015-0017 0020 0023-0025 0027-0030 0032-0037  
 0039-0041 0044-0045 0047-0060 0062 0064-0073 0076-0079 0082-0084 0086-0150 0152-0155  
 0157-0158 0160-0177 0179-0203 0205-0370 0372-0375 0377-0382 0384-0390 0392-0393  
 0395-0409 0411-0415 0418-0425 0427-0430 0432-0435 0437-0439 0441-0444 0446-0448  
 0450-0452 0454-0456 0458-0459 0461-0463 0465-0467 0469-0470 0472-0474 0476-0477  
 0479-0481 0483-0484 0486-0487 0489-0491 0493-0494 0496-0498 0500-0513 0515-0516  
 0518-0519 0521-0522 0524-0530 0532-0533 0535-0536 0538-0539 0541-0542 0544-0546  
 0548-0556 0558-0559 0561-0562 0564-0565 0567-0568 0570-0571 0573-0574 0576 0578-0579  
 0581-0582 0584-0585 0587-0600 0602-0603 0605 0607 0609-0610 0612-0614 0616 0618  
 0620-0621 0623 0625 0627 0629 0631-0638 0640-0671 0673-0676 0678-0680 0682-0684  
 0686-0688 0690-0693 0695-0697 0699-0701 0703-0705 0707-0709 0711-0714 0716-0718  
 0720-0722 0724-0726 0728-0730 0732-0735 0737-0739 0741-0743 0745-0747 0749-0752  
 0754-0756 0758-0760 0769-0770 0772-0774 0776-0778 0780-0782 0784-0786 0788-0789  
 0791-0793 0795-0797 0799-0803 0805-0811 0813-0828 0830-0836 0838-0845 0847 0849-0860

If pitch attitude exceeds 7.5°, the PNF will announce "PITCH".

MSN 0004 0006 0008-0011 0014 0018-0019 0021-0022 0026 0031 0038 0043 0046 0061  
 0063 0074-0075 0080-0081 0085 0151 0156 0159 0178 0204

If pitch attitude exceeds 10°, the PNF will announce "PITCH".

R MSN 0371 0376 0383 0391 0394 0410 0416-0417 0426 0431 0436 0440 0445 0449 0453  
 0457 0460 0464 0468 0471 0475 0478 0482 0485 0488 0492 0495 0499 0514 0517 0520  
 0523 0531 0534 0537 0540 0543 0547 0557 0560 0563 0566 0569 0572 0575 0577 0580  
 0583 0586 0601 0604 0606 0608 0611 0615 0617 0619 0622 0624 0626 0628 0630 0639  
 0672 0677 0681 0685 0689 0694 0698 0702 0706 0710 0715 0719 0723 0727 0731 0736  
 0740 0744 0748 0753 0757 0761-0768 0771 0775 0779 0783 0787 0790 0794 0798 0804  
 0812 0829 0837 0846 0848

PITCH PITCH auto call out is provided.

If pitch attitude approaches the tailstrike pitch limit on PFD, the PNF will announce "PITCH"

**DEROTATION**

R MSN 0002-0860

	<b>NORMAL OPERATIONS</b>	02.160
	<b>LANDING</b>	JAN 09/07

When the aircraft is on the ground, pitch and roll control operates in Direct Law. Consequently, when the aircraft touches down, the pilot flies the nose down conventionally, varying sidestick input as required, to control the derotation rate.

After touch down, when reverse thrust is selected (on at least one engine) and one main landing gear strut is compressed, the ground spoilers partially extend to establish ground contact. The ground spoilers fully extend when both main landing gears are compressed. A small nose down term on the elevators is introduced by the control law, which compensates the pitch up tendency with ground spoiler extension

It is not recommended to keep the nose high in order to increase aircraft drag during the initial part of the roll-out, as this technique is inefficient and increases the risk of tail strike. Furthermore, if auto brake MED is used, it may lead to a hard nose gear touch down.

During the derotation phase, it is normal to feel 3 successive "shocks" or "contacts with the ground"; the first from aft wheels of the MLG boogie, the second from the front wheels of the MLG boogie, the third from the NLG.

## ROLL OUT

R MSN 0002-0860

### NORMAL CONDITIONS

During the roll out, the rudder pedals will be used to steer the aircraft on the runway centreline. At high speed, directional control is achieved with rudder. As the speed reduces, the Nose Wheel Steering (NWS) becomes active. However, the NWS tiller will not be used until taxi speed is reached.

### CROSSWIND CONDITIONS

The above-mentioned technique applies. Additionally, the pilot will avoid to set stick into the wind as it increases the weathercock effect. Indeed, it creates a differential down force on the wheels into the wind side.

The reversers have a destabilizing effect on the airflow around the rudder and thus decrease the efficiency of the rudder. Furthermore they create a side force, in case of a remaining crab angle, which increases the lateral skidding tendency of the aircraft. This adverse effect is quite noticeable on contaminated runways

	<b>NORMAL OPERATIONS</b>	02.160
	LANDING	JAN 09/07

with crosswind. In case a lateral control problem occurs in high crosswind landing, the pilot will consider to set reversers back to Idle.

At lower speeds, the directional control of the aircraft is more problematic, more specifically on wet and contaminated runways. Differential braking is to be used if necessary. On wet and contaminated runways, the same braking effect may be reached with full or half deflection of the pedals; additionally the anti skid system releases the brake pressure on both sides very early when the pilot presses on the pedals. Thus if differential braking is to be used, the crew will totally release the pedal on the opposite side to the expected turn direction.

## BRAKING

R MSN 0002-0860

Once on the ground, the importance of the timely use of all means of stopping the aircraft cannot be overemphasised. Three systems are involved in braking once the aircraft is on the ground:

- . The ground spoilers
- . The thrust reversers
- . The wheel brakes

### **THE GROUND SPOILERS**

When the aircraft touches down with at least one main landing gear and when at least one thrust lever is in the reverse sector, the ground spoilers partially automatically deploy to ensure that the aircraft is properly sit down on ground. This is the partial lift dumping function. Then, the ground spoilers automatically fully deploy.

The ground spoilers contribute to aircraft deceleration by increasing aerodynamic drag at high speed. Wheel braking efficiency is improved due to the increased load on the wheels. Additionally, the ground spoiler extension signal is used for auto-brake activation.

### **THRUST REVERSERS**

Thrust reverser efficiency is proportional to the square of the speed. So, it is recommended to use reverse thrust at high speeds.



	<b>NORMAL OPERATIONS</b>	02.160
	<b>LANDING</b>	JAN 09/07

Pull to reverse IDLE at main landing gear touchdown (not before). When REV is indicated in green on ECAM, MAX reverse may be applied.

The maximum reverse thrust is obtained at N1 between 70% and 85% and is controlled by the FADEC.

Below 70 kts, reversers efficiency decreases rapidly, and below 60 kts with maximum reverse selected, there is a risk of engine stall. Therefore, it is recommended to smoothly reduce the reverse thrust to idle at 70 kts. However, the use of maximum reverse is allowed down to aircraft stop in case of emergency.

If airport regulations restrict the use of reverse, select and maintain reverse idle until taxi speed is reached.

Stow the reversers before leaving the runway to avoid foreign object ingestion.

### **WHEEL BRAKES**

Wheel brakes contribute the most to aircraft deceleration on the ground. Many factors may affect efficient braking such as load on the wheels, tire pressure, runway pavement characteristics and runway contamination and braking technique. The only factor over which the pilot has any control is the use of the correct braking technique, as discussed below.

### **ANTI-SKID**

The anti-skid system adapts pilot applied brake pressure to runway conditions by sensing an impending skid condition and adjusting the brake pressure to each individual wheel as required. The anti-skid system maintains the skidding factor (slip ratio) close to the maximum friction force point. This will provide the optimum deceleration with respect to the pilot input. Full pedal braking with anti-skid provides a deceleration rate of 10 kts/sec.

### **BRAKES**

The use of auto brake versus pedal braking should observe the following guidelines:

- . The use of A/BRAKE is usually preferable because it minimizes the number of application of brake and thus reduces brake wear. Additionally, the A/BRAKE provides a symmetrical brake pressure application which ensures an equal braking effect on both main landing gear wheels on wet or evenly contaminated runway. More particularly, the A/BRAKE is recommended on short, wet, contaminated runway, in poor visibility conditions and in Auto land.

	<b>NORMAL OPERATIONS</b>	02.160
	LANDING	JAN 09/07

The use of LO auto brake should be preferred on long and dry runways whereas the use of MED auto brake should be preferred for short or contaminated runways. The use of MAX auto brake is not recommended.

- . On very short runways, the use of pedal braking is to be envisaged since the pilot may apply full pedal braking with no delay after touch down.
- . On very long runways, the use of pedal braking may be envisaged if the pilot anticipates that braking will not be needed. To reduce brake wear, the number of brake application should be limited.
- . In case of pedal braking, do not ride the brakes but apply pedal braking when required and modulate the pressure without releasing. This minimizes brake wear.

The DECEL light indicates that the selected deceleration rate is or is not achieved, irrespective of the functioning of the autobrake. For example DECEL might not come up when the autobrake is selected on a contaminated runway, because the deceleration rate is not reached with the autobrake properly functioning, whereas DECEL light might come up with LO selected on Dry runway while the only reversers achieve the selected deceleration rate without autobrake being actually activated. In other words, the DECEL light is not an indicator of the autobrake operation as such, but that the deceleration rate is reached.

Since the auto brake system senses deceleration and modulates brake pressure accordingly, the timely application of MAX reverse thrust will reduce the actual operation of the brakes themselves, thus the brake wear and temperature.

Auto-brake does not relieve the pilot of the responsibility of achieving a safe stop within the available runway length.

### **CROSS WIND CONDITIONS**

The reverse thrust side force and crosswind component can combine to cause the aircraft to drift to the downwind side of the runway if the aircraft is allowed to weathercock into wind after landing. Additionally, as the anti-skid system will be operating at maximum braking effectiveness, the main gear tire cornering forces available to counteract this drift will be reduced.

#### **BRAKING FORCE AND CORNERING FORCE VS SKID RATIO**

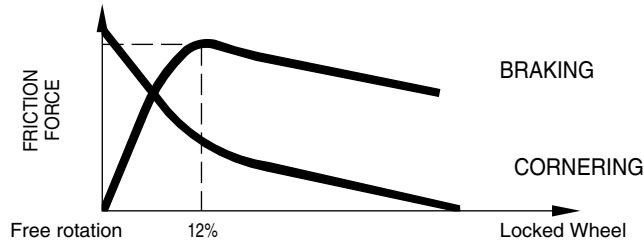

FOF 02160 03837 0001

To correct back to the centreline, the pilot must reduce reverse thrust to reverse idle and release the brakes. This will minimise the reverse thrust side force component, without the requirement to go through a full reverser actuating cycle, and provide the total tire cornering forces for realignment with the runway centreline. Rudder and differential braking should be used, as required, to correct back to the runway centreline. When re-established on the runway centreline, the pilot should re-apply braking and reverse thrust as required.

DIRECTIONAL CONTROL DURING CROSSWIND LANDING

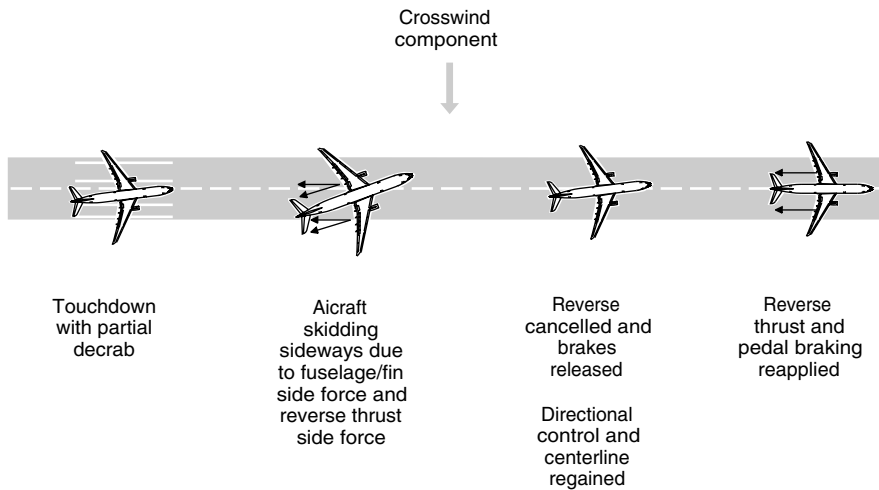

FOF 02160 03838 0001

	<b>NORMAL OPERATIONS</b>	02.160
	<b>LANDING</b>	JAN 09/07

**FACTORS AFFECTING LANDING DISTANCE**

R MSN 0002-0860

The field length requirements are contained in the Landing Performance chapter of the FCOM 2. The landing distance margin will be reduced if the landing technique is not correct. Factors that affect stopping distance include:

- . Height and speed over the threshold
- . Glide slope angle
- . Landing flare technique
- . Delay in lowering the nose on to the runway
- . Improper use of braking system
- . Runway conditions (discussed in adverse weather).

Height of the aircraft over the runway threshold has a significant effect on total landing distance. For example, on a 3° glide path, passing over the runway threshold at 100 ft altitude rather than 50 ft could increase the total landing distance by approximately 300m/950ft. This is due to the length of runway used before the aircraft touches down.

A 5 kts speed increment on VAPP produces a 5% increase in landing distance with auto brake selected.

For a 50 ft Threshold Crossing Height, a shallower glide path angle increases the landing distance, as the projected touchdown point will be further down the runway.

Floating above the runway before touchdown must be avoided because it uses a large portion of the available runway. The aircraft should be landed as near the normal touchdown point as possible. Deceleration rate on the runway is approximately three times greater than in the air.

Reverse thrust and speedbrake drag are most effective during the high-speed portion of the landing. Therefore, reverse thrust should be selected without delay.

Speed brakes fully deployed, in conjunction with maximum reverse thrust and maximum manual anti-skid braking provides the minimum stopping distance.

**OPERATIONAL FACTORS AFFECTING ACTUAL LANDING DISTANCE**

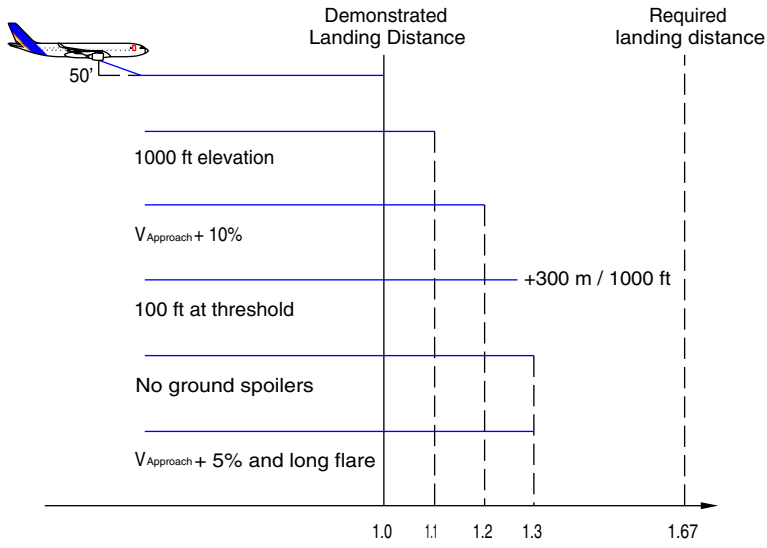

FOF 02160 03839 0001

**CLEARANCE AT TOUCH DOWN**

R MSN 0181 0195 0205 0211 0222-0223 0226 0229-0230 0232 0238 0240 0247-0251  
 0253-0255 0258-0259 0261-0262 0265-0266 0269 0271-0272 0275-0276 0281 0283 0285-0291  
 0293-0296 0299-0301 0303 0305-0306 0308-0309 0311-0314 0316-0317 0320 0322 0324  
 0326 0328 0330 0334 0339-0340 0343 0345 0348 0353 0358 0361-0362 0364-0366 0369  
 0372 0382 0384 0392 0396-0398 0401 0403-0404 0409 0422 0427 0432 0437 0441  
 0443-0444 0448 0451-0452 0454-0456 0458 0461-0463 0465-0466 0469 0472-0473 0476-0477  
 0480-0481 0486-0487 0489 0491 0493-0494 0498 0500-0511 0513 0516 0518-0519 0521-0522  
 0525-0527 0529-0530 0532 0535-0536 0551 0555 0567 0571 0573 0584 0587 0597 0600  
 0605 0609-0610 0612-0614 0616 0618 0620-0621 0625 0627 0631-0635 0638 0644 0647  
 0649-0650 0652-0653 0655-0658 0660-0661 0664-0667 0678 0682-0684 0686 0688 0693  
 0696-0697 0700 0703-0704 0709 0717-0718 0722 0724 0726 0728-0730 0732-0733 0735  
 0737-0739 0742-0743 0745-0747 0749-0751 0754-0756 0759-0760 0770 0774 0778 0780  
 0785 0788 0792 0795-0797 0801-0802 0807-0811 0814-0815 0818-0822 0824-0825 0828  
 0831-0832 0834 0839-0842 0849 0852-0854 0860

Geometry limit at touch down	Pitch attitude at $V_{APP}(V_{ref}+5kt)$ (1)	Pitch attitude at touch down	Clearance(2)
------------------------------	----------------------------------------------	------------------------------	--------------

16 °	4.5 °	6.8 °	9.2 °
------	-------	-------	-------

Note: (1) Flight path in approach: -3°  
(2) Clearance = geometry limit - pitch attitude at touch down

R MSN 0012 0017 0030 0037 0045 0050 0054-0055 0059-0060 0062 0064-0073 0077  
0082-0083 0086-0087 0095-0096 0098-0100 0102 0106-0113 0116 0118-0122 0127 0132  
0138 0140 0143-0144 0148 0153 0155 0162 0165 0171-0172 0177 0183-0184 0188-0189  
0191 0198 0200 0203 0206 0209 0219 0224 0231 0234 0241 0244 0256 0267 0277  
0279 0284 0315 0323 0333 0337-0338 0342 0344 0346 0349-0351 0356-0357 0368 0370  
0375 0380 0386 0388-0389 0393 0400 0405 0407-0408 0412 0418-0421 0423 0425 0428  
0439 0479 0484 0490 0496-0497 0512 0515 0524 0533 0539 0542 0548-0550 0552-0553  
0558 0564-0565 0568 0570 0574 0576 0578-0579 0581 0588 0591-0595 0602-0603 0607  
0623 0629 0636-0637 0640-0642 0645 0648 0654 0659 0662-0663 0669-0671 0673-0676  
0679-0680 0687 0690-0692 0695 0699 0701 0705 0707-0708 0711-0714 0716 0720-0721  
0725 0734 0741 0752 0758 0769 0772-0773 0776-0777 0781-0782 0784 0786 0789 0791  
0799 0803 0805-0806 0813 0817 0823 0826-0827 0830 0833 0836 0838 0843 0845 0847  
0850-0851 0855-0859

Geometry limit at touch down	Pitch attitude at VAPP(Vref+5kt) (1)	Pitch attitude at touch down	Clearance(2)
14.2 °	4.3 °	6.6 °	7.6 °

Note: (1) Flight path in approach: -3°  
(2) Clearance = geometry limit - pitch attitude at touch down

R MSN 0002-0003 0005 0007 0013 0015-0016 0020 0023-0025 0027-0029 0032-0035 0039-0041  
0044 0047-0049 0051-0053 0056-0058 0076 0078-0079 0084 0088-0094 0097 0101 0103-0104  
0114-0115 0117 0123-0126 0128-0131 0133-0137 0139 0141-0142 0145-0147 0149-0150 0152  
0154 0157-0158 0160-0161 0163-0164 0166-0170 0173-0176 0179-0180 0182 0185-0187  
0190 0192-0194 0196-0197 0199 0201-0202 0207-0208 0210 0212-0218 0220-0221 0225  
0227-0228 0233 0235-0237 0239 0242-0243 0245-0246 0252 0257 0260 0263-0264 0268  
0270 0273-0274 0278 0280 0282 0292 0297 0302 0304 0307 0310 0318-0319 0321 0325  
0327 0329 0331-0332 0335 0347 0352 0354-0355 0359 0363 0367 0373-0374 0377-0379  
0381 0385 0387 0390 0395 0399 0402 0406 0411 0413-0415 0424 0429-0430 0433-0435  
0438 0442 0446-0447 0450 0459 0467 0470 0474 0483 0528 0538 0541 0544-0546 0554  
0556 0559 0561-0562 0582 0585 0590 0598 0643 0646 0651 0668 0793 0800 0835 0844

Geometry limit at touch down	Pitch attitude at VAPP(Vref+5kt) (1)	Pitch attitude at touch down	Clearance(2)
14.2 °	4.3 °	6.6 °	7.6 °

	<b>NORMAL OPERATIONS</b>	02.160
	LANDING	JAN 09/07

**Note:** (1) Flight path in approach:  $-3^{\circ}$   
(2) Clearance = geometry limit - pitch attitude at touch down

R MSN 0394 0445 0457 0464 0471 0478 0485 0492 0495 0499 0520 0560 0563 0572 0608  
0611 0624 0628 0685 0694 0698 0748 0757 0761 0775 0783

Geometry limit at touch down	Pitch attitude at VAPP(Vref+5kt) (1)	Pitch attitude at touch down	Clearance(2)
$13.5^{\circ}$	$3.6^{\circ}$	$6.2^{\circ}$	$7.3^{\circ}$

**Note:** (1) Flight path in approach:  $-3^{\circ}$   
(2) Clearance = geometry limit - pitch attitude at touch down

R MSN 0371 0376 0383 0391 0410 0416-0417 0426 0431 0436 0440 0449 0453 0460 0468  
0475 0482 0488 0514 0517 0523 0531 0534 0537 0540 0543 0547 0557 0566 0569 0575  
0577 0580 0583 0586 0601 0604 0606 0615 0617 0619 0622 0626 0630 0639 0672 0677  
0681 0689 0702 0706 0710 0715 0719 0723 0727 0731 0736 0740 0744 0753 0762-0768  
0771 0779 0787 0790 0794 0798 0804 0812 0829 0837 0846 0848

Geometry limit at touch down	Pitch attitude at VAPP(Vref+5kt) (1)	Pitch attitude at touch down	Clearance(2)
$12^{\circ}$	$3.8^{\circ}$	$6.4^{\circ}$	$5.6^{\circ}$

**Note:** (1) Flight path in approach:  $-3^{\circ}$   
(2) Clearance = geometry limit - pitch attitude at touch down

MSN 0004 0006 0008-0011 0014 0018-0019 0021-0022 0026 0031 0038 0043 0046 0061  
0063 0074-0075 0080-0081 0085 0151 0156 0159 0178 0204

Geometry limit at touch down	Pitch attitude at VAPP(Vref+5kt) (1)	Pitch attitude at touch down	Clearance(2)
$15.8^{\circ}$	$4.4^{\circ}$	$6.7^{\circ}$	$9.1^{\circ}$

**Note:** (1) Flight path in approach:  $-3^{\circ}$   
(2) Clearance = geometry limit - pitch attitude at touch down

**TAIL STRIKE AVOIDANCE**

	<b>NORMAL OPERATIONS</b>  LANDING	02.160
		JAN 09/07

R MSN 0002-0860

Although most of tail strikes are due to deviations from normal landing techniques, some are associated with such external conditions as turbulence and wind gradient.

### **DEVIATION FROM NORMAL TECHNIQUES**

Deviations from normal landing techniques are the most common causes of tail strikes. The main reasons for this are due to:

- . Allowing the speed to decrease well below VAPP before flare  
Flying at too low speed means high angle of attack and high pitch attitude, thus reducing ground clearance. When reaching the flare height, the pilot will have to significantly increase the pitch attitude to reduce the sink rate. This may cause the pitch to go beyond the critical angle.
- . Prolonged hold off for a smooth touch down  
As the pitch increases, the pilot needs to focus further ahead to assess the aircraft's position in relation to the ground. The attitude and distance relationship can lead to a pitch attitude increase beyond the critical angle.
- . Too high flare  
A high flare can result in a combined decrease in airspeed and a long float. Since both lead to an increase in pitch attitude, the result is reduced tail clearance.
- . Too high sink rate, just prior reaching the flare height  
In case of too high sink rate close to the ground, the pilot may attempt to avoid a firm touch down by commanding a high pitch rate. This action will significantly increase the pitch attitude and, as the resulting lift increase may be insufficient to significantly reduce the sink rate, the high pitch rate may be difficult to control after touch down, particularly in case of bounce.
- . Bouncing at touch down  
In case of bouncing at touch down, the pilot may be tempted to increase the pitch attitude to ensure a smooth second touch down. If the bounce results from a firm touch down, associated with high pitch rate, it is important to control the pitch so that it does not further increase beyond the critical angle.

### **APPROACH AND LANDING TECHNIQUES**



	<b>NORMAL OPERATIONS</b>	02.160
	<b>LANDING</b>	JAN 09/07

A stabilized approach is essential for achieving successful landings. It is imperative that the flare height be reached at the appropriate airspeed and flight path angle. The A/THR and FPV are effective aids to the pilot. VAPP should be determined with the wind corrections (provided in FCOM/QRH) by using the FMGS functions. As a reminder, when the aircraft is close to the ground, the wind intensity tends to decrease and the wind direction to turn (direction in degrees decreasing in the northern latitudes). Both effects may reduce the head wind component close to the ground and the wind correction to VAPP is there to compensate for this effect.

When the aircraft is close to the ground, high sink rate should be avoided, even in an attempt to maintain a close tracking of the glideslope. Priority should be given to the attitude and sink rate. If a normal touchdown distance is not possible, a go-around should be performed.

If the aircraft has reached the flare height at VAPP, with a stabilized flight path angle, the normal SOP landing technique will lead to repetitive touch down attitude and airspeed.

During the flare, the pilot should not concentrate on the airspeed, but only on the attitude with external cues.

Specific PNF call outs have been reinforced for excessive pitch attitude at landing.

***Note:** On the 340-500/600, a "PITCH-PITCH" aural warning is activated if the pitch attitude monitored by the FG reaches a given limit. This aural warning is only available in manual flight at landing when the aircraft height is lower than 14 ft. In addition, a pitch limit indication is provided on the PFD at landing under 400 ft.*

After touch down, the pilot must "fly" the nosewheel smoothly, but without delay, on to the runway, and must be ready to counteract any residual pitch up effect of the ground spoilers. However, the main part of the spoiler pitch up effect is compensated by the flight control law itself.

### **BOUNCING AT TOUCH DOWN**

In case of light bounce, maintain the pitch attitude and complete the landing, while keeping the thrust at idle. Do not allow the pitch attitude to increase, particularly following a firm touch down with a high pitch rate.

In case of high bounce, maintain the pitch attitude and initiate a go-around. Do not try to avoid a second touch down during the go-around. Should it happen, it would be soft enough to prevent damage to the aircraft, if pitch attitude is maintained.

Only when safely established in the go-around, retract flaps one step and the landing gear. A landing should not be attempted immediately after high bounce,

	<b>NORMAL OPERATIONS</b>	02.160
	<b>LANDING</b>	JAN 09/07

as thrust may be required to soften the second touch down and the remaining runway length may be insufficient to stop the aircraft.

**CUMULATIVE EFFECTS**

No single factor should result in a tail strike, but accumulation of several can significantly reduce the margin.

	NORMAL OPERATIONS LANDING	02.160
		JAN 09/07

**HIGHLIGHTS**

- (1) More detailed recommendations for flare, especially regarding lateral and directional control.

	<b>NORMAL OPERATIONS</b>  GO AROUND	02.170
		JAN 09/07

**PREFACE**

R MSN 0002-0860

Failure to recognize the need for and to execute a go-around, when required, is a major cause of approach and landing accidents. Because a go-around is an infrequent occurrence, it is important to be "go-around minded". The decision to go-around should not be delayed, as an early go-around is safer than a last minute one at lower altitude.

**CONSIDERATIONS ABOUT GO-AROUND**

R MSN 0002-0860

A go-around must be considered if:

- . There is a loss or a doubt about situation awareness
- . If there is a malfunction which jeopardizes the safe completion of the approach e.g. major navigation problem
- . ATC changes the final approach clearance resulting in rushed action from the crew or potentially unstable approach
- . The approach is unstable in speed, altitude, and flight path in such a way that stability will not be obtained by 1000 ft IMC or 500 ft VMC.
- . Any GPWS, TCAS or windshears alert occur
- . Adequate visual cues are not obtained reaching the minima.

**AP/FD GO-AROUND PHASE ACTIVATION**

R MSN 0067-0069 0072-0073 0077 0089-0090 0095 0100-0101 0104 0107 0110 0116-0117 0119 0143 0151 0212 0215 0230 0276 0281 0286-0287 0315 0323 0333-0334 0337 0340-0342 0370 0375 0380 0388

The go-around phase is activated when the thrust levers are set to TOGA, provided the flap lever is selected to Flap 1 or greater. The FDs are displayed

	<b>NORMAL OPERATIONS</b>	02.170
	GO AROUND	JAN 09/07

automatically and SRS and GA TRK modes engage. The missed approach becomes the active F-PLN and the previously flown approach is strung back into the F-PLN.

For the go-around, the appropriate flight reference is the attitude, because go-around is a dynamic maneuver. Therefore, if the "bird" is on, the PF will ask the PNF to select HDG/VS, in order to remove the bird. This also permits to replace the FPD by the FD bars.

If TOGA thrust is not required during a go-around for any reason, e.g. an early go-around ordered by ATC, it is essential that thrust levers are set to TOGA momentarily to sequence the F-PLN. If this is not done, the destination airfield will be sequenced and the primary FPLN will become PPOS DISCONT- .

R MSN 0002-0066 0070-0071 0074-0076 0078-0088 0091-0094 0096-0099 0102-0103 0106 0109 0111-0115 0118 0120-0142 0144-0150 0152-0211 0213-0214 0216-0229 0231-0275 0277-0280 0282-0285 0288-0314 0316-0322 0324-0332 0335 0338-0339 0343-0369 0371-0374 0376-0379 0381-0387 0389-0860

The go-around phase is activated when the thrust levers are set to TOGA, provided the flap lever is selected to Flap 1 or greater. The FDs are displayed automatically and SRS and GA TRK modes engage. The missed approach becomes the active F-PLN and the previously flown approach is strung back into the F-PLN.

For the go-around, the appropriate flight reference is the attitude, because go-around is a dynamic maneuver. Therefore, if the "bird" is on, it is automatically removed and the FD bars automatically replace the FPD.

If TOGA thrust is not required during a go-around for any reason, e.g. an early go-around ordered by ATC, it is essential that thrust levers are set to TOGA momentarily to sequence the F-PLN. If this is not done, the destination airfield will be sequenced and the primary FPLN will become PPOS DISCONT- .

### GO-AROUND PHASE

R MSN 0002-0860

R (1)

The SRS mode guides the aircraft with a maximum speed of VLS, VAPP, or IAS at time of TOGA selection (limited to maximum of VAPP + 25 with all engines operative or VAPP + 15 with one engine inoperative) until the acceleration altitude where the target speed increases to green dot.

The GA TRK mode guides the aircraft on the track memorised at the time of TOGA selection. The missed approach route becomes the ACTIVE F-PLN provided the waypoints have been correctly sequenced on the approach. Pushing for NAV enables the missed approach F-PLN to be followed.

When the pilot sets TOGA thrust for go-around, it takes some time for the engines to spool up due to the acceleration capability of the high by pass ratio engines. Therefore, the pilot must be aware that the aircraft will initially lose some altitude. This altitude loss will be greater if initial thrust is close to idle and/or the aircraft speed is lower than VAPP.

**ATTITUDE LOSS FOLLOWING A GO AROUND**

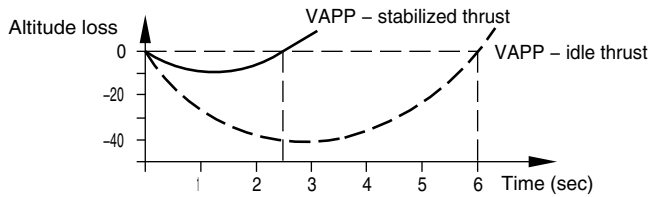

FOF 02170 03830 0001

Above the go-around acceleration altitude, or when the flight crew engages another vertical mode (CLB, OP CLB), the target speed is green dot.

R MSN 0002-0860

**LEAVING THE GO-AROUND PHASE**

The purpose of leaving the go-around phase is to obtain the proper target speed and proper predictions depending upon the strategy chosen by the crew. During the missed approach, the crew will elect either of the following strategies:

- . Fly a second approach
- . Carry out a diversion

**SECOND APPROACH**

	<b>NORMAL OPERATIONS</b>  GO AROUND	02.170
		JAN 09/07

If a second approach is to be flown, the crew will activate the approach phase in the MCDU PERF GO-AROUND page. The FMS switches to Approach phase and the target speed moves according to the flaps lever setting, e.g. green dot for Flaps 0.

The crew will ensure proper waypoint sequencing during the second approach in order to have the missed approach route available, should a further go-around be required.

### **DIVERSION**

Once the aircraft path is established and clearance has been obtained, the crew will modify the FMGS to allow the FMGS switching from go-around phase to climb phase:

- . If the crew has prepared the ALTN F-PLN in the active F-PLN, a lateral revision at the TO WPT is required to access the ENABLE ALTN prompt. On selecting the ENABLE ALTN prompt, the lateral mode reverts to HDG if previously in NAV. The aircraft will be flown towards the next waypoint using HDG or NAV via a DIR TO entry.
- . If the crew has prepared the ALTN F-PLN in the SEC F-PLN, the SEC F-PLN will be activated, and a DIR TO performed as required. AP/FD must be in HDG mode for the ACTIVATE SEC F-PLN prompt to be displayed.
- . If the crew has not prepared the ALTN FPLN, a selected climb will be initiated. Once established in climb and clear of terrain, the crew will make a lateral revision at any waypoint to insert a NEW DEST. The route and a CRZ FL (on PROG page) can be updated as required.

The crew will check the defaulted CRZ FL on PROG page and Cl, (consistent with diversion strategy), on PERF page.

### **REJECTED LANDING**

R MSN 0002-0860

A rejected landing is defined as a go-around manoeuvre initiated below the minima.

Once the decision is made to reject the landing, the flight crew must be committed to proceed with the go-around manoeuvre and not be tempted to retard the thrust levers in a late decision to complete the landing.

	<b>NORMAL OPERATIONS</b>	02.170
	GO AROUND	JAN 09/07

TOGA thrust must be applied but a delayed flap retraction should be considered. If the aircraft is on the runway when thrust is applied, a CONFIG warning will be generated if the flaps are in conf full. The landing gear should be retracted when a positive rate of climb is established with no risk of further touch down. Climb out as for a standard go-around.

In any case, if reverse thrust has been applied, a full stop landing must be completed.



	NORMAL OPERATIONS GO AROUND	02.170
		JAN 09/07

**HIGHLIGHTS**

- (1) Enhancement of the description of the target speed logic.

	<b>NORMAL OPERATIONS</b>  TAXI IN	02.180
		JAN 09/07

### BRAKE TEMPERATURE

R MSN 0002-0860

The use of brake fans could increase oxidation of the brake surface hot spots if brakes are not thermally equalized, leading to the rapid degradation of the brakes. For this reason, selection of brake fans should be delayed until approximately five minutes after touchdown or just prior to stopping at the gate (whichever occurs first).

When reaching the gate, if there is a significant difference in brake temperature between the wheels of the same gear, this materializes a potential problem with brake e.g. if one wheel reaches the limit temperature of 600 °C while all others wheels brakes indicate less than 400 °C to 450 °C, this indicates that there is a potential problem of brake binding or permanent brake application on that wheel. Conversely, if one wheel brake is at or below 60 °C whereas the others are beyond 200 °C, this indicates that there is a potential loss of braking on that wheel.

If brake temperature is above 500 °C with fans OFF (350 °C fans ON), use of the parking brake, unless operationally necessary, should be avoided to prevent brake damage.

The MMEL provides information regarding brake ground cooling time, both with and without brake fans.

### ENGINES COOLING PERIOD

R MSN 0002-0860

To avoid engine thermal stress, it is required that the engine be operated at, or near, idle for a cooling period as described in FCOM 3.03.25

### TAXI WITH ONE ENGINE SHUTDOWN

R MSN 0012 0017 0030 0037 0045 0050 0054-0055 0059-0060 0062 0064-0073 0077  
 0082-0083 0086-0087 0095-0096 0098-0100 0102 0106-0113 0116 0118-0122 0127 0132 0138  
 0140 0143-0144 0148 0153 0155 0162 0165 0171-0172 0177 0181 0183-0184 0188-0189  
 0191 0195 0198 0200 0203 0205-0206 0209 0211 0219 0222-0224 0226 0229-0232 0234  
 0238 0240-0241 0244 0247-0251 0253-0256 0258-0259 0261-0262 0265-0267 0269 0271-0272  
 0275-0277 0279 0281 0283-0291 0293-0296 0299-0301 0303 0305-0306 0308-0309 0311-0317  
 0320 0322-0324 0326 0328 0330 0333-0334 0337-0346 0348-0351 0353 0356-0358 0361-0362  
 0364-0366 0368-0370 0372 0375 0380 0382 0384 0386 0388-0389 0392-0393 0396-0398  
 0400-0401 0403-0405 0407-0409 0412 0418-0423 0425 0427-0428 0432 0437 0439 0441  
 0443-0444 0448 0451-0452 0454-0456 0458 0461-0463 0465-0466 0469 0472-0473 0476-0477  
 0479-0481 0484 0486-0487 0489-0491 0493-0494 0496-0498 0500-0513 0515-0516 0518-0519  
 0521-0522 0524-0527 0529-0530 0532-0533 0535-0536 0539 0542 0548-0553 0555 0558  
 0564-0565 0567-0568 0570-0571 0573-0574 0576 0578-0579 0581 0584 0587-0588 0591-0597  
 0600 0602-0603 0605 0607 0609-0610 0612-0614 0616 0618 0620-0621 0623 0625 0627  
 0629 0631-0638 0640-0642 0644-0645 0647-0650 0652-0667 0669-0671 0673-0676 0678-0680  
 0682-0684 0686-0688 0690-0693 0695-0697 0699-0701 0703-0705 0707-0709 0711-0714  
 0716-0718 0720-0722 0724-0726 0728-0730 0732-0735 0737-0739 0741-0743 0745-0747  
 0749-0752 0754-0756 0758-0760 0769-0770 0772-0774 0776-0778 0780-0782 0784-0786  
 0788-0789 0791-0792 0795-0797 0799 0801-0803 0805-0811 0813-0828 0830-0834 0836  
 0838-0843 0845 0847 0849-0860

R (1)

Refer to 02.040

**TAXI WITH TWO ENGINES SHUTDOWN**

MSN 0002-0011 0013-0016 0018-0029 0031-0035 0038-0044 0046-0049 0051-0053 0056-0058  
 0061 0063 0074-0076 0078-0081 0084-0085 0088-0094 0097 0101 0103-0104 0114-0115 0117  
 0123-0126 0128-0131 0133-0137 0139 0141-0142 0145-0147 0149-0152 0154 0156-0161  
 0163-0164 0166-0170 0173-0176 0178-0180 0182 0185-0187 0190 0192-0194 0196-0197 0199  
 0201-0202 0204 0207-0208 0210 0212-0218 0220-0221 0225 0227-0228 0233 0235-0237  
 0239 0242-0243 0245-0246 0252 0257 0260 0263-0264 0268 0270 0273-0274 0278 0280  
 0282 0292 0297 0302 0304 0307 0310 0318-0319 0321 0325 0327 0329 0331-0332  
 0335 0347 0352 0354-0355 0359 0363 0367 0371 0373-0374 0376-0379 0381 0383 0385  
 0387 0390-0391 0394-0395 0399 0402 0406 0410-0411 0413-0417 0424 0426 0429-0431  
 0433-0436 0438 0440 0442 0445-0447 0449-0450 0453 0457 0459-0460 0464 0467-0468  
 0470-0471 0474-0475 0478 0482-0483 0485 0488 0492 0495 0499 0514 0517 0520 0523  
 0528 0531 0534 0537-0538 0540-0541 0543-0547 0554 0556-0557 0559-0563 0566 0569  
 0572 0575 0577 0580 0582-0583 0585-0586 0590 0598 0601 0604 0606 0608 0611 0615  
 0617 0619 0622 0624 0626 0628 0630 0639 0643 0646 0651 0668 0672 0677 0681 0685  
 0689 0694 0698 0702 0706 0710 0715 0719 0723 0727 0731 0736 0740 0744 0748 0753  
 0757 0761-0768 0771 0775 0779 0783 0787 0790 0793-0794 0798 0800 0804 0812 0829  
 0835 0837 0844 0846 0848

R (2)

Refer to 02.040

**AFTER LANDING FLOW PATTERN**

R MSN 0002-0860

AFTER LANDING FLOW PATTERN

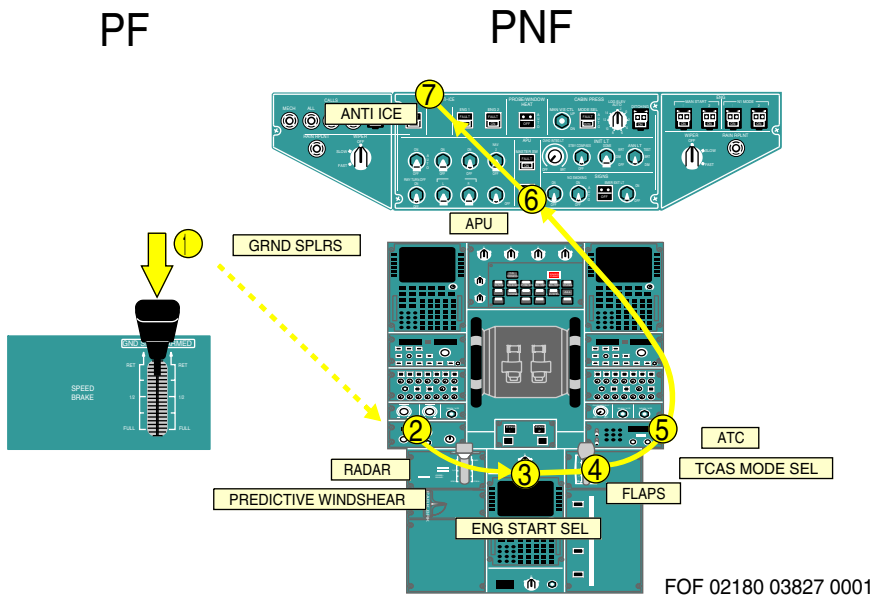

	<b>NORMAL OPERATIONS</b>  TAXI IN	02.180
		JAN 09/07

<b>HIGHLIGHTS</b>
-------------------

- (1) Correction of printing error
- (2) New item 'TAXI WITH TWO ENGINES SHUTDOWN' for 'MSN 0002-0011 0013-0016 0018-0029 0031-0035 0038-0044 0046-0049 0051-0053 0056-0058 0061 0063 0074-0076 0078-0081 0084-0085 0088-0094 0097 0101 0103-0104 0114-0115 0117 0123-0126 0128-0131 0133-0137 0139 0141-0142 0145-0147 0149-0152 0154 0156-0161 0163-0164 0166-0170 0173-0176 0178-0180 0182 0185-0187 0190 0192-0194 0196-0197 0199 0201-0202 0204 0207-0208 0210 0212-0218 0220-0221 0225 0227-0228 0233 0235-0237 0239 0242-0243 0245-0246 0252 0257 0260 0263-0264 0268 0270 0273-0274 0278 0280 0282 0292 0297 0302 0304 0307 0310 0318-0319 0321 0325 0327 0329 0331-0332 0335 0347 0352 0354-0355 0359 0363 0367 0371 0373-0374 0376-0379 0381 0383 0385 0387 0390-0391 0394-0395 0399 0402 0406 0410-0411 0413-0417 0424 0426 0429-0431 0433-0436 0438 0440 0442 0445-0447 0449-0450 0453 0457 0459-0460 0464 0467-0468 0470-0471 0474-0475 0478 0482-0483 0485 0488 0492 0495 0499 0514 0517 0520 0523 0528 0531 0534 0537-0538 0540-0541 0543-0547 0554 0556-0557 0559-0563 0566 0569 0572 0575 0577 0580 0582-0583 0585-0586 0590 0598 0601 0604 0606 0608 0611 0615 0617 0619 0622 0624 0626 0628 0630 0639 0643 0646 0651 0668 0672 0677 0681 0685 0689 0694 0698 0702 0706 0710 0715 0719 0723 0727 0731 0736 0740 0744 0748 0753 0757 0761-0768 0771 0775 0779 0783 0787 0790 0793-0794 0798 0800 0804 0812 0829 0835 0837 0844 0846 0848'

<b>03.010</b>	<b>GENERAL</b>	
	- PREFACE	1
	- LANDING DISTANCE PROC	1
	- VAPP DETERMINATION	1
	- IN FLIGHT LANDING DISTANCE CALCULATION FOLLOWING FAILURES	5
<b>03.020</b>	<b>OPERATING TECHNIQUES</b>	
	- LOW SPEED ENGINE FAILURE	1
	- REJECTED TAKE-OFF	1
	- INTRODUCTION TO EMERGENCY EVACUATION	5
	- THE EMERGENCY EVACUATION C/L	6
	- TASKSHARING IN CASE OF EMERGENCY EVACUATION	7
	- ENGINE FAILURE AFTER V1	9
	- ENGINE FAILURE DURING INITIAL CLIMB	12
	- ENGINE FAILURE DURING CRUISE	13
	- ONE ENGINE-OUT LANDING	15
	- CIRCLING ONE ENGINE INOPERATIVE	16
	- ONE ENGINE INOPERATIVE GO-AROUND	17
	- TWO-ENGINE INOPERATIVE LANDING	18
<b>03.022</b>	<b>AUTOFLIGHT</b>	
	- FMGC FAILURE	1
<b>03.024</b>	<b>ELECTRICAL</b>	
	- INTRODUCTION TO EMERGENCY ELECTRICAL CONFIGURATION	1
	- TECHNICAL BACKGROUND	1
	- GENERAL GUIDELINES	2
	- REMAINING SYSTEMS	3
	- RESTORATION FROM EMER ELEC	5
<b>03.026</b>	<b>FIRE PROTECTION</b>	
	- PREFACE	1
	- SMOKE DETECTION AND PROCEDURE APPLICATION	1

	<b>ABNORMAL OPERATIONS</b>	03.000
	TABLE OF CONTENTS	JAN 09/07

	- COORDINATION WITH CABIN CREW	2
	- SMOKE/FUMES/AVNCS SMOKE PAPER PROCEDURE	3
	- CARGO SMOKE	6
<b>03.027</b>	<b>FLIGHT CONTROLS</b>	
	- ABNORMAL FLAPS/SLATS CONFIGURATION	1
	- ELEVATOR REDUNDANCY LOST	3
<b>03.028</b>	<b>FUEL</b>	
	- FUEL LEAK	1
<b>03.029</b>	<b>HYDRAULIC</b>	
	- HYDRAULIC GENERATION PARTICULARITIES	1
	- DUAL HYDRAULIC FAILURES	2
	- REMAINING SYSTEMS	4
<b>03.032</b>	<b>LANDING GEAR</b>	
	- LDG WITH ABNORMAL L/G	1
<b>03.034</b>	<b>NAVIGATION</b>	
	- ADR/IRS FAULT	1
	- UNRELIABLE AIRSPEED INDICATIONS	1
	- ADR CHECK PROC / UNRELIABLE SPEED INDICATION QRH PROCEDURE	4
	- DUAL RADIO ALTIMETER FAILURE	9
<b>03.070</b>	<b>POWER PLANT</b>	
	- ALL ENGINE FLAMEOUT	1
<b>03.090</b>	<b>MISCELLANEOUS</b>	
	- EMERGENCY DESCENT	1
	- OVERWEIGHT LANDING	3
	- CREW INCAPACITATION	8

	<b>ABNORMAL OPERATIONS</b>	03.010
	GENERAL	JAN 09/07

R MSN 0002-0860

### PREFACE

The ABNORMAL OPERATIONS chapter highlights techniques that will be used in some abnormal and emergency operations. Some of the procedures discussed in this chapter are the result of double or triple failures. Whilst it is very unlikely that any of these failures will be encountered, it is useful to have a background understanding of the effect that they have on the handling and management of the aircraft. In all cases, the ECAM should be handled as described in FCTM OPERATIONAL PHILOSOPHY- ECAM 01.004.

### LANDING DISTANCE PROC

R MSN 0002-0860

Should a failure occur with "LANDING DISTANCE PROC APPLY" message displayed on the ECAM STATUS page, the crew will enter the LDG CONF/APP SPD/LDG DIST/ CORRECTIONS FOLLOWING FAILURES table in QRH chapter 2 and read:

- . The flap lever position for landing
- . Delta Vref if required for Vapp determination
- . The landing distance factor for landing distance calculation

### VAPP DETERMINATION

R MSN 0002-0860

R (1)

### BACKGROUND

Some failures affect the approach speed.



	<b>ABNORMAL OPERATIONS</b>	03.010
	GENERAL	JAN 09/07

- . Some failures (typically slat or flap failure) increase the VLS. In this case, the VLS displayed on the PFD (if available) takes into account the actual configuration.
- . In some others failures, it is required to fly at speed higher than VLS to improve the handling characteristics of the aircraft. It is the reason why the ECAM provide a speed increment, called Delta VLS. This speed increment is to be added to the VLS displayed on the PFD when the landing configuration is reached.

In all cases,

$$V_{app} = VLS \text{ (PFD)} + \underbrace{\Delta VLS \text{ (ECAM)}}_{\text{When required}} + \text{Wind correction}$$

FOF 03010 03739 0001

In order to prepare the approach and landing, the crew needs to know VAPP in advance. The appropriate VLS is not necessarily available at that time on the PFD, because the landing configuration is not yet established. Hence, VAPP is determined using Delta VREF, which is the VLS of CONF FULL, and is available both in MCDU PERF APPR page and QRH. Delta VREF, extracted from the QRH, is then added.

$$V_{app} = V_{ref} + \underbrace{\Delta V_{ref}}_{\text{When required}} + \text{Wind correction}$$

FOF 03010 03741 0001

**DELTA VREF ON QRH VERSUS DELTA VLS ON PFD**

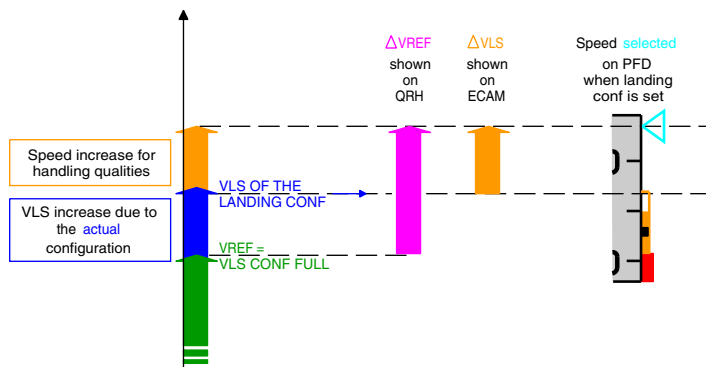

FOF 03010 03742 0001

**METHOD**

If the QRH shows a Delta VREF:

R (2)

**VAPP COMPUTATION PRINCIPLE WITH DELTA VREF**



	<b>ABNORMAL OPERATIONS</b>	03.010
	GENERAL	JAN 09/07

**If the QRH shows no Delta Vref:**

Proceed as for normal operations (Use the MCDU Vapp, as computed by FMS).

**IN FLIGHT LANDING DISTANCE CALCULATION FOLLOWING FAILURES**

R MSN 0002-0860

R (3)

R (4)

**GENERAL**

The actual landing distance (from 50 ft above the runway surface until the aircraft comes to the complete stop) is measured during specific flight tests for the certification of the aircraft. This distance represents the absolute performance capability of the aircraft. It is published without safety margin under the name "LANDING DISTANCE WITHOUT AUTOBRAKE" in the QRH.

To compute the actual landing distance following any failure affecting the landing performance, the crew multiplies the "LANDING DISTANCE WITHOUT AUTOBRAKE" CONFIGURATION FULL by the associated landing distance factor found in the QRH. This actual landing distance following a failure is computed with no safety margin.

The flight crew checks this actual landing distance against the Landing Distance Available (LDA) of the runway used for landing applying the relevant safety margins.

The safety margins to be applied depend of the circumstances according to:

- . the Captain judgement
- . the Airline policy
- . the applicable regulations

**Note:** For example:

*The US-FAA recommends to apply a minimum safety margin of 15% between the actual landing distance and the Landing Distance Available (LDA) in case of*

- . *in-flight determination of the landing distance*
- . *normal and abnormal conditions (except in an emergency)*

*Ref: US-FAA SAFO 06012 dated 31 Aug 2006.*

	<b>ABNORMAL OPERATIONS</b>  GENERAL	03.010
		JAN 09/07

R (5)

**DRY RUNWAY**

The landing distance calculation does NOT include the effect of thrust reversers.

**Landing distance with failure = Landing distance (1) x Failure factor "dry" (2)**

(1): LANDING DISTANCE WITHOUT AUTOBRAKE CONFIGURATION FULL (QRH chapter 4 IN FLIGHT PERFORMANCE)

(2): Failure factor "dry" from QRH chapter 2 ABNORMAL PROCEDURES APPR SPD increment and Landing distance factor table

**Reverse thrust credit:**

For the failure cases for which ALL thrust reversers remain available it is possible to include the effect of reverse thrust in the calculation.

**Landing distance with failure = Landing distance (1) x Reverse credit (3) x Failure factor "dry" (2)**

(3): LANDING DISTANCE WITHOUT AUTOBRAKE CONFIGURATION FULL - CORRECTIONS table Reversers operative (QRH chapter 4 IN FLIGHT PERFORMANCE)

R (6)

**WET OR CONTAMINATED RUNWAY**

The landing distance calculation includes the effect of all available thrust reversers.

Whatever is the failure, the actual landing distance found in the table "LANDING DISTANCE WITHOUT AUTOBRAKE" CONFIGURATION FULL must be corrected by the reversers credit.

When applicable, the failure factors take into account the loss of one or more thrust reversers due to the related failure.

*Note: This method does not permit to compute the landing distance with NO REVERSE thrust credit*

**Landing distance with failure = Landing distance (1) x Reverse credit (3) x Failure factor "wet or contaminated" (2)**

	<b>ABNORMAL OPERATIONS</b>	03.010
	GENERAL	JAN 09/07

### HIGHLIGHTS

- (1) Correction of printing error
- (2) graph enhancement
- (3) Clarification of calculation method
- (4) New item 'General'
- (5) New item 'Dry Runway'
- (6) New item 'Wet or Contaminated Runway'

	<b>ABNORMAL OPERATIONS</b>	03.020
	OPERATING TECHNIQUES	JAN 09/07

### LOW SPEED ENGINE FAILURE

R MSN 0002-0860

If an engine failure occurs at low speed, the resultant yaw may be significant, leading to rapid displacement from the runway centreline. For this reason, it is essential that the Captain keeps his hand on the thrust levers once take-off thrust has been set. Directional control is achieved by immediately closing the thrust levers and using maximum rudder and braking. If necessary, the nosewheel tiller should be used to avoid runway departure.

R MSN 0002-0860

R (1)

### REJECTED TAKE-OFF

#### **FACTORS AFFECTING RTO**

Experience has shown that a rejected take-off can be hazardous, even if correct procedures are followed. Some factors that can detract from a successful rejected take-off are as follows:

- . Tire damage
- . Brakes worn or not working correctly
- . Error in gross weight determination
- . Incorrect performance calculations
- . Incorrect runway line-up technique
- . Initial brake temperature
- . Delay in initiating the stopping procedure
- . Runway friction coefficient lower than expected

Thorough pre-flight preparation and a conscientious exterior inspection can eliminate the effect of some of these factors.

During the taxi-out, a review of the take-off briefing is required. During this briefing, the crew should confirm that the computed take-off data reflects the actual take-off conditions e.g. wind and runway condition. Any changes to the planned conditions require the crew to re-calculate the take-off data. In this case,

	<b>ABNORMAL OPERATIONS</b>	03.020
	OPERATING TECHNIQUES	JAN 09/07

the crew should not be pressurised into accepting a take-off clearance before being fully ready. Similarly, the crew should not accept an intersection take-off until the take-off performance has been checked.

The line-up technique is very important. The pilot should use the over steer technique to minimize field length loss and consequently, to maximize the acceleration-stop distance available.

R (2)

### **DECISION MAKING**

A rejected take-off is a potentially hazardous manoeuvre and the time for decision making is limited. To minimize the risk of inappropriate decisions to reject a take-off, many warnings and cautions are inhibited between 80 kts and 1500 ft. Therefore, any warnings received during this period must be considered as significant.

To assist in the decision making process, the take-off is divided into low and high speeds regimes, with 100 kts being chosen as the dividing line. The speed of 100 kts is not critical but was chosen in order to help the Captain make the decision and to avoid unnecessary stops from high speed.

- . Below 100 kts, the Captain will seriously consider discontinuing the take-off if any ECAM warning/caution is activated.
- . Above 100 kts, and approaching V1, the Captain should be "go-minded" and only reject the take-off in the event of a major failure, sudden loss of thrust, any indication that the aircraft will not fly safely, or if one of the following ECAM warning/caution occurs:
  - . ENG or APU FIRE
  - . ENG FAIL
  - . CONFIG
  - . ENG OIL LO PR
  - . ENG REV UNLOCK
  - . L+R ELEV FAULT
  - . SIDESTICK FAULT

If a tire fails within 20 kts of V1, unless debris from the tire has caused noticeable engine parameter fluctuations, it is better to get airborne, reduce the fuel load and land with a full runway length available.

The decision to reject the take-off is the responsibility of the Captain and must be made prior to V1 speed.

- . If a malfunction occurs before V1, for which the Captain does not intend to reject the take-off, he will announce his intention by calling "GO".
- . If a decision is made to reject the take-off, the Captain calls "STOP". This call both confirms the decision to reject the take-off and also states that the



Captain now has control. It is the only time that hand-over of control is not accompanied by the phrase "I have control".

**RTO PROCEDURE**

Should a RTO procedure is initiated, the following task sharing will be applied.

CAPT	F/O
Calls ..... "STOP" Thrust levers ..... IDLE Reverse thrust ..... MAX AVAIL	Calls ..... "REVERSE GREEN" "DECEL(*)" "70 kt"
 	Cancels any audio warning
<u>Aircraft stopped</u>	
Reverse ..... STOWED Parking brake ..... APPLY PA call ..... "ATTENTION CREW AT STATION" Calls for ..... "ECAM ACTION"	Advises ATC Locates on ground EMER EVAC C/L  Completes the ECAM ACTIONS

FOF 03020 03775 0001

(\*): "DECEL" call means that the deceleration is felt by the crew, and confirmed by the Vc trend on the PFD. It can also be confirmed by the DECEL light; however, this light only indicates that the selected deceleration rate is or is not achieved, irrespective of the functioning of the autobrake. DECEL light might not come up on a contaminated runway, with the autobrake working properly, due to the effect of the antiskid.

If the take-off is rejected prior to 72kts, the spoilers will not deploy and the auto-brake will not function.

If a rejected take-off is initiated and MAX auto brake decelerates the aircraft, the captain will avoid pressing the pedals (which might be a reflex action). Conversely, if deceleration is not felt, the captain will press the brake pedals fully down.

If take-off has been rejected due to an engine fire, the ECAM actions will be completed until shutting down the remaining engines.

REJECTED TAKE OFF FLOW PATTERN

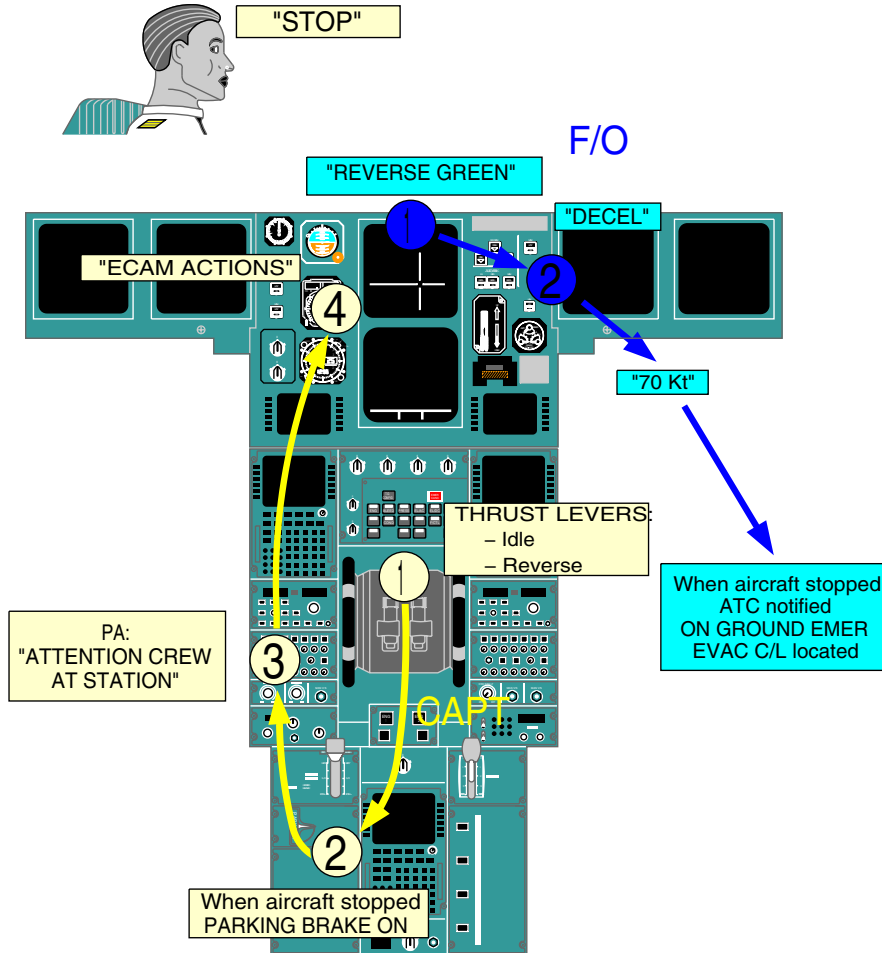

FOF 03020 03782 0001

	<b>ABNORMAL OPERATIONS</b>	03.020
	OPERATING TECHNIQUES	JAN 09/07

## INTRODUCTION TO EMERGENCY EVACUATION

R MSN 0002-0860

### GENERAL

The typical case, which may require an emergency evacuation, is an uncontrollable on ground engine fire. This situation, which may occur following a rejected take-off or after landing, requires good crew coordination to cope with a high workload situation.

### DECISION MAKING

As soon as aircraft is stopped, the parking brake set, the captain notifies the cabin crew and calls for ECAM ACTIONS. At this stage, the task sharing is defined as follow:

- . The first officer carries out the ECAM actions until shutting down the remaining engine(s).
- . The captain builds up his decision to evacuate depending on the circumstances. Considerations should be given to:
  - Possible passenger evacuation of the aircraft on the runway.
  - Vacating the runway as soon as possible.
  - Communicating intentions or requests to ATC.

If fire remains out of control after having discharged the fire agents, the captain calls for the **EMERGENCY EVACUATION** C/L located in the inside back cover of the QRH.

## THE EMERGENCY EVACUATION C/L

	<b>ABNORMAL OPERATIONS</b>	03.020
	<b>OPERATING TECHNIQUES</b>	JAN 09/07

R MSN 0007 0012 0017 0022 0030 0033-0034 0037-0040 0045 0048 0050 0054-0055  
0058-0062 0064-0073 0077 0080 0082-0083 0085-0090 0095-0113 0116-0122 0127 0129-0133  
0138 0140-0141 0143-0144 0148 0150 0153-0155 0159 0161-0162 0165 0167 0170-0172  
0175 0177-0179 0181-0184 0188-0189 0191 0195 0198 0200 0202-0203 0205-0206 0209  
0211-0212 0215-0216 0219 0222-0224 0226 0229-0232 0234 0236 0238 0240-0241 0244  
0247-0251 0253-0259 0261-0262 0265-0267 0269 0271-0273 0275-0279 0281-0296 0299-0301  
0303 0305-0306 0308-0309 0311-0317 0320 0322-0324 0326 0328 0330 0333-0334 0337-0346  
0348-0351 0353 0356-0358 0361-0362 0364-0370 0372 0374-0375 0380 0382 0384 0386  
0388-0389 0392-0393 0396-0398 0400-0401 0403-0405 0407-0410 0412 0417-0423 0425  
0427-0428 0432 0437 0439-0441 0443-0444 0448 0451-0452 0454-0456 0458 0460-0466  
0469 0472-0473 0476-0477 0479-0481 0484 0486-0487 0489-0491 0493-0494 0496-0498  
0500-0505 0507 0509-0512 0515-0516 0518-0519 0521 0525-0527 0529-0530 0532 0534-0536  
0538-0539 0544-0548 0550-0551 0554 0556-0557 0559-0563 0565 0567-0568 0581 0584  
0586 0597 0619 0627 0635 0657 0660 0672 0689 0698 0702

Some items need to be highlighted:

- . It is essential that the differential pressure be zeroed.  
In automatic pressurization mode, the crew can rely on the CPC, and the Delta P check is therefore not applicable.  
If MAN CAB PRESS is used in flight, the CAB PR SYS (1+2) FAULT procedure requires selecting MAN V/S CTL to FULL UP position during final approach to cancel any residual cabin pressure. However, since the residual pressure sensor indicator, installed in the cabin door, is inhibited with slides armed, an additional Delta P check is required by the **EMERGENCY EVACUATION C/L**. Since MAN CAB PRESS is never used for take-off as at least one automatic cabin pressure control must be operative for departure, the Delta P check does not apply to the case of emergency evacuation following a rejected takeoff.
- . CABIN CREW (PA)ALERT reminds the captain for the "CABIN CREW AT STATION" call out.
- . EVACUATIONINITIATE requires
  - The cabin crew to be notified to launch evacuation and
  - EVAC command activation.
This will be done preferably in this order for a clear understanding by cabin crew.

On ground with engines stopped, the right dome light automatically illuminates whatever the dome switch position is, allowing the **EMERGENCY EVACUATION C/L** completion.

When aircraft is on batteries power, the crew seats can only be operated mechanically.

	<b>ABNORMAL OPERATIONS</b>	03.020
	OPERATING TECHNIQUES	JAN 09/07

R MSN 0002-0006 0008-0011 0013-0016 0018-0021 0023-0029 0031-0032 0035 0041-0044 0046-0047 0049 0051-0053 0056-0057 0063 0074-0076 0078-0079 0081 0084 0091-0094 0114-0115 0123-0126 0128 0134-0137 0139 0142 0145-0147 0149 0151-0152 0156-0158 0160 0163-0164 0166 0168-0169 0173-0174 0176 0180 0185-0187 0190 0192-0194 0196-0197 0199 0201 0204 0207-0208 0210 0213-0214 0217-0218 0220-0221 0225 0227-0228 0233 0235 0237 0239 0242-0243 0245-0246 0252 0260 0263-0264 0268 0270 0274 0280 0297 0302 0304 0307 0310 0318-0319 0321 0325 0327 0329 0331-0332 0335 0347 0352 0354-0355 0359 0363 0371 0373 0376-0379 0381 0383 0385 0387 0390-0391 0394-0395 0399 0402 0406 0411 0413-0416 0424 0426 0429-0431 0433-0436 0438 0442 0445-0447 0449-0450 0453 0457 0459 0467-0468 0470-0471 0474-0475 0478 0482-0483 0485 0488 0492 0495 0499 0506 0508 0513-0514 0517 0520 0522-0524 0528 0531 0533 0537 0540-0543 0549 0552-0553 0555 0558 0564 0566 0569-0580 0582-0583 0585 0587-0595 0598-0618 0620-0626 0628-0634 0636-0656 0658-0659 0661-0671 0673-0688 0690-0697 0699-0701 0703-0860

Some items need to be highlighted:

- . CABIN CREW (PA)ALERT reminds the captain for the "CABIN CREW AT STATION" call out.
- . EVACUATIONINITIATE requires
  - The cabin crew to be notified to launch evacuation and
  - EVAC command activation.
 This will be done preferably in this order for a clear understanding by cabin crew.

On ground with engines stopped, the right dome light automatically illuminates whatever the dome switch position is, allowing the **EMERGENCY EVACUATION** C/L completion.

When aircraft is on batteries power, the crew seats can only be operated mechanically.

R MSN 0002-0860

R (3)

**TASKSHARING IN CASE OF EMERGENCY EVACUATION**

TASK SHARING IN CASE OF EMERGENCY EVACUATION

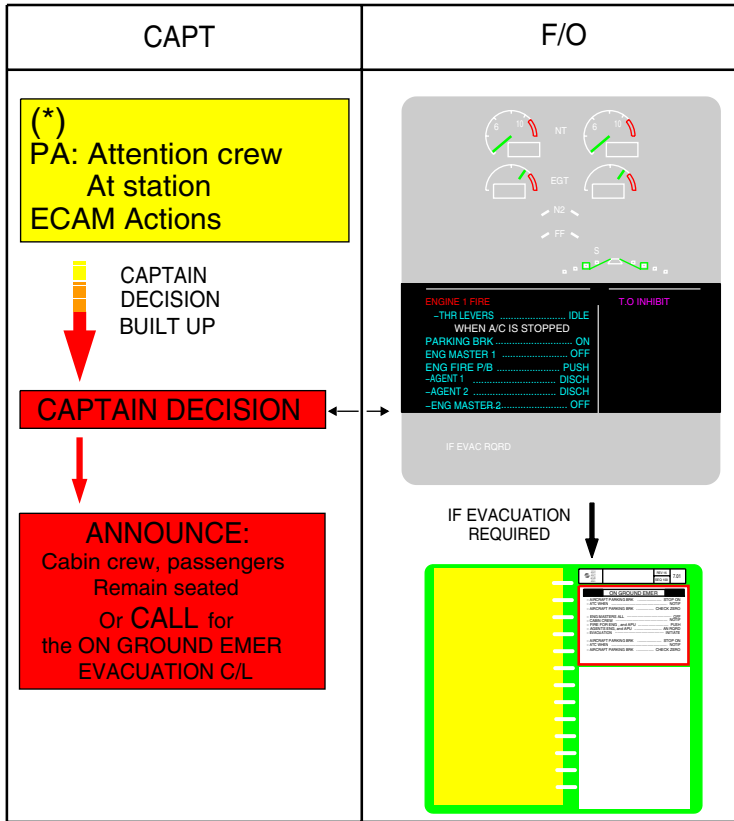

FOF 03020 04283 0001

(\*) In the rejected take-off case, the captain calls STOP. This confirms that the Captain has controls.

Following landing and after the parking brake is set, the Captain calls "I HAVE CONTROLS" if required to state the control hand over.

	<b>ABNORMAL OPERATIONS</b>	03.020
	OPERATING TECHNIQUES	JAN 09/07

When applying the emergency evacuation procedure, the F/O can select the engine master OFF and push the fire pushbutton, without any confirmation from the Captain.

## ENGINE FAILURE AFTER V1

R MSN 0002-0860

### AIRCRAFT HANDLING

If an engine fails after V1 the take-off must be continued. The essential and primary tasks are linked to aircraft handling. The aircraft must be stabilized at the correct pitch and airspeed, and established on the correct track prior to the initiation of the ECAM procedure.

#### **ON THE GROUND:**

Rudder is used conventionally to maintain the aircraft on the runway centreline.

At VR, rotate the aircraft smoothly, at a slower rate than with all engines operating, using a continuous pitch rate to an initial pitch attitude of 12.5°. The combination of high FLEX temperatures and low V speeds requires precise handling during the rotation and lift-off. The 12.5° pitch target will ensure the aircraft becomes airborne.

#### **WHEN SAFELY AIRBORNE:**

The SRS orders should then be followed which may demand a lower pitch attitude to acquire or maintain V2.

With a positive rate of climb and when the Radio Altitude has increased, the PNF will call "positive climb". This will suggest to the PF for landing gear retraction.

Shortly after lift off, the Lateral normal law commands some rudder surface deflection to minimize the sideslip (there is no feedback of this command to the pedals). Thus, the lateral behavior of the aircraft is safe and the pilot should not be in a hurry to react on the rudder pedals and to chase the beta target.

The blue beta target will replace the normal sideslip indication on the PFD. Since the lateral normal law does not command the full needed rudder surface deflection, the pilot will have to adjust conventionally the rudder pedals to center the beta target.

	<b>ABNORMAL OPERATIONS</b>	03.020
	OPERATING TECHNIQUES	JAN 09/07

When the beta target is centred, total drag is minimized even though there is a small amount of sideslip. The calculation of the beta target is a compromise between drag produced by deflection of control surfaces and airframe drag produced by a slight sideslip. Centering the beta target produces less total drag than centering a conventional ball, as rudder deflection, aileron deflection, spoiler deployment and aircraft body angle are all taken into account.

The crew will keep in mind that the yaw damper reacts to a detected side slip. This means that, with hands off the stick and no rudder input, the aircraft will bank at about 5° maximum and then, will remain stabilized. Thus, laterally, the aircraft is a stable platform and no rush is required to laterally trim the aircraft. Control heading conventionally with bank, keeping the beta target at zero with rudder. Accelerate if the beta target cannot be zeroed with full rudder. Trim the rudder conventionally.

The use of the autopilot is **STRONGLY** recommended. Following an engine failure, the rudder should be trimmed out prior to autopilot engagement.

Once AP is engaged, the rudder trim is managed through the AP and, hence, manual rudder trim command, including reset, is inhibited.

### **THRUST CONSIDERATIONS**

Consider the use of TOGA thrust, keeping in mind the following:

- . For a FLEX takeoff, selecting the operating engine(s) to TOGA provides additional performance margin but is not a requirement of the reduced thrust takeoff certification. The application of TOGA will very quickly supply a large thrust increase but this comes with a significant increase in yawing moment and an increased pitch rate. The selection of TOGA restores thrust margins but it may be at the expense of increased workload in aircraft handling.
- . For a derated takeoff, asymmetric TOGA thrust cannot be applied if the speed is below F in CONF 2 or 3 due to VMCA considerations.

### **PROCEDURE**

#### **INITIATION OF THE PROCEDURE**

The PNF will closely monitor the aircraft's flight path. He will cancel any Master Warning/Caution and read the ECAM title displayed on the top line of the E/WD.

Procedures are initiated on PF command. No action is taken (apart from cancelling audio warnings through the MASTER WARNING light) until:

- . The appropriate flight path is established and,



	<b>ABNORMAL OPERATIONS</b>	03.020
	OPERATING TECHNIQUES	JAN 09/07

. The aircraft is at least 400 ft above the runway, if a failure occurs during take-off approach or go-around.

A height of 400 ft is recommended because it is a good compromise between the necessary time for stabilization and the excessive delay in procedure initiation. In some emergency cases and provided the flight path is established, the PF may initiate the ECAM actions before 400 ft.

Once the PF has stabilized the flight path, the PNF confirms the failure. If it is necessary to delay the ECAM procedure, the PF should order "Standby", otherwise he should announce "ECAM actions".

Priority must be given to the control of aircraft trajectory, and acceleration phase should not be delayed for the purpose of applying the ENG FAIL ECAM procedure.

Should the PF require an action from the PNF during ECAM procedures, the order "STOP ECAM" should be used. When ready to resume ECAM procedure, the order "CONTINUE ECAM" should be used.

The procedure may be continued until "ENG MASTER OFF" (in case of engine failure without damage) or until AGENT 1 DISCH (in case of engine failure with damage) before acceleration.

*Note: In case of ENG FIRE, fire drill remains high priority.*

#### **ACCELERATION SEGMENT**

At the engine-out acceleration altitude, push ALT to level off and allow the speed to increase. If the aircraft is being flown manually, the PF should remember that, as airspeed increases, the rudder input needed to keep the beta target centred will reduce. Retract the flaps as normal. When the flap lever is at zero, the beta target reverts to the normal sideslip indication.

#### **FINAL TAKE-OFF SEGMENT**

As the speed trend arrow reaches Green Dot speed, pull for OPEN CLIMB, set THR MCT when the LVR MCT message flashes on the FMA (triggered as the speed index reaches green dot) and resume climb using MCT. If the thrust levers are already in the FLX/MCT detent, move levers to CL and then back to MCT.

When an engine failure occurs after take-off, noise abatement procedures are no longer a requirement. Additionally, the acceleration altitude provides a compromise between obstacle clearance and engine thrust limiting time. It allows the aircraft to be configured to Flap 0 and green dot speed, which provides the best climb gradient.

Once established on the final take-off flight path, continue the ECAM until the STATUS is displayed. At this point, the AFTER T/O checklist should be

completed, computer reset considered and OEBs consulted (if applicable). STATUS should then be reviewed.

**ONE ENGINE OUT FLIGHT PATH**

The one engine out flight path will be flown according to the take-off briefing made at the gate:

- . The EOSID (with attention to the decision point location)
- . The SID
- . Radar vector...

ENGINE FAILURE AFTER V1

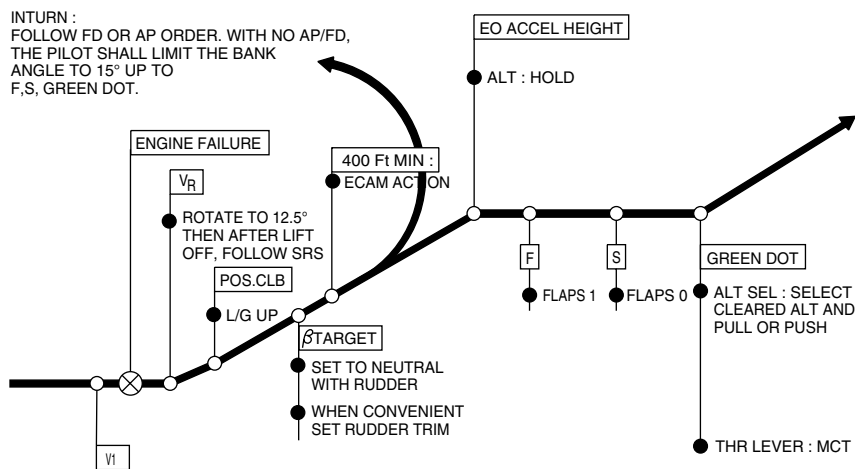

FOF 03020 03785 0001

**ENGINE FAILURE DURING INITIAL CLIMB**

R MSN 0002-0860

	<b>ABNORMAL OPERATIONS</b>	03.020
	OPERATING TECHNIQUES	JAN 09/07

Proceed as above. If the failure occurs above V2 however, maintain the SRS commanded attitude. In any event the minimum speed must be V2.

When an engine failure is detected, the FMGS produces predictions based on the engine-out configuration and any pre-selected speeds entered in the MCDU are deleted.

## ENGINE FAILURE DURING CRUISE

R MSN 0002-0860

### GENERAL

There are three strategies available for dealing with an engine failure in the cruise:

- . The standard strategy
- . The obstacle strategy
- . The fixed speed strategy

The fixed speed strategy refers to ETOPS (A330 only). It is discussed in FCOM 2 "special operations" and is taught as a separate course.

Unless a specific procedure has been established before dispatch (considering ETOPS or mountainous areas), the standard strategy is used.

### PROCEDURE

As soon as the engine failure is recognized, the PF will simultaneously:

- . Set MCT on the remaining engine(s)
- . Disconnect A/THR

Then, PF will

- . Select the SPEED according to the strategy
- . If appropriate, select a HDG to keep clear of the airway, preferably heading towards an alternate. Consideration should be given to aircraft position relative to any relevant critical point
- . Select the appropriate engine inoperative altitude in the FCU ALT window and pull for OPEN DES

Then, PF will

. Require the ECAM actions

At high flight levels close to limiting weights, crew actions should not be delayed, as speed will decay quickly requiring prompt crew response. The crew will avoid decelerating below green dot.

ENGINE FAILURE DURING CRUISE FLOW PATTERN

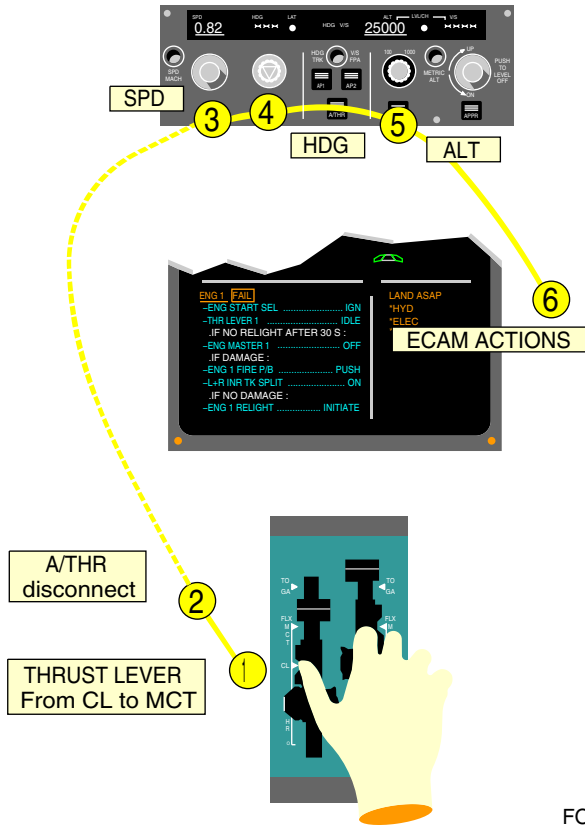

FOF 03020 03786 0001

The A/THR is disconnected to avoid any engine thrust reduction when selecting speed according to strategy or when pulling for OPEN DES to initiate the descent. With the A/THR disconnected, the target speed is controlled by the elevator when in OPEN DES.

	<b>ABNORMAL OPERATIONS</b>	03.020
	OPERATING TECHNIQUES	JAN 09/07

Carrying out the ECAM actions should not be hurried, as it is important to complete the drill correctly. Generally, there will be sufficient time to cross check all actions.

### **STANDARD STRATEGY**

Set speed target .82M/300kt. The speed of .82/300kt is chosen to ensure the aircraft is within the stabilised windmill engine relight in-flight envelope.

The REC MAX EO Cruise altitude, which equates to LRC with anti-icing off, is displayed on the MCDU PROG page and should be set on the FCU. (Cruise altitude and speed are also available in the QRH in case of double FM failure).

If V/S becomes less than 500 fpm, select V/S 500 fpm and A/THR on. This is likely to occur as level off altitude is approached.

Once established at level off altitude, long-range cruise performance with one engine out may be extracted from QRH or FCOM3.06.30.

### **OBSTACLE STRATEGY**

To maintain the highest possible level due to terrain, the drift down procedure must be adopted. The speed target in this case is green dot. The procedure is similar to the standard strategy, but as the speed target is now green dot, the rate and angle of descent will be lower.

The MCDU PERF CRZ page in EO condition will display the drift down ceiling, assuming green dot speed and should be set on FCU. (One engine out gross ceiling at green dot speed is also available in the QRH and FCOM).

If, having reached the drift down ceiling altitude, obstacle problems remain, the drift down procedure must be maintained so as to fly an ascending cruise profile.

When clear of obstacles, set LRC ceiling on FCU, return to LRC speed and engage A/THR.

## **ONE ENGINE-OUT LANDING**

R MSN 0002-0860

Autoland is available with one engine inoperative, and maximum use of the AP should be made to minimise crew workload. If required, a manual approach and landing with one engine inoperative is conventional. The pilot should trim to keep

the slip indication centred. It remains yellow as long as the thrust on the remaining engine(s) is below a certain value. With flap selected and above this threshold value, the indicator becomes the blue beta target. This is a visual cue that the aircraft is approaching its maximum thrust capability.

Do not select the gear down too early, as large amounts of power will be required to maintain level flight at high weights and/or high altitude airports.

To make the landing run easier, the rudder trim may be reset to zero in the later stages of the approach. On pressing the rudder trim reset button, the trim is removed and the pilot should anticipate the increased rudder force required. With rudder trim at zero, the neutral rudder pedal position corresponds to zero rudder and zero nose wheel deflection.

**CIRCLING ONE ENGINE INOPERATIVE**

R MSN 0012 0017 0030 0037 0045 0050 0054-0055 0059-0060 0062 0064-0073 0077  
 0082-0083 0086-0087 0095-0096 0098-0100 0102 0106-0113 0116 0118-0122 0127 0132 0138  
 0140 0143-0144 0148 0153 0155 0162 0165 0171-0172 0177 0181 0183-0184 0188-0189  
 0191 0195 0198 0200 0203 0205-0206 0209 0211 0219 0222-0224 0226 0229-0232 0234  
 0238 0240-0241 0244 0247-0251 0253-0256 0258-0259 0261-0262 0265-0267 0269 0271-0272  
 0275-0277 0279 0281 0283-0291 0293-0296 0299-0301 0303 0305-0306 0308-0309 0311-0317  
 0320 0322-0324 0326 0328 0330 0333-0334 0337-0346 0348-0351 0353 0356-0358 0361-0362  
 0364-0366 0368-0370 0372 0375 0380 0382 0384 0386 0388-0389 0392-0393 0396-0398  
 0400-0401 0403-0405 0407-0409 0412 0418-0423 0425 0427-0428 0432 0437 0439 0441  
 0443-0444 0448 0451-0452 0454-0456 0458 0461-0463 0465-0466 0469 0472-0473 0476-0477  
 0479-0481 0484 0486-0487 0489-0491 0493-0494 0496-0498 0500-0513 0515-0516 0518-0519  
 0521-0522 0524-0527 0529-0530 0532-0533 0535-0536 0539 0542 0548-0553 0555 0558  
 0564-0565 0567-0568 0570-0571 0573-0574 0576 0578-0579 0581 0584 0587-0588 0591-0597  
 0600 0602-0603 0605 0607 0609-0610 0612-0614 0616 0618 0620-0621 0623 0625 0627  
 0629 0631-0638 0640-0642 0644-0645 0647-0650 0652-0667 0669-0671 0673-0676 0678-0680  
 0682-0684 0686-0688 0690-0693 0695-0697 0699-0701 0703-0705 0707-0709 0711-0714  
 0716-0718 0720-0722 0724-0726 0728-0730 0732-0735 0737-0739 0741-0743 0745-0747  
 0749-0752 0754-0756 0758-0760 0769-0770 0772-0774 0776-0778 0780-0782 0784-0786  
 0788-0789 0791-0792 0795-0797 0799 0801-0803 0805-0811 0813-0828 0830-0834 0836  
 0838-0843 0845 0847 0849-0860

In normal conditions, circling with one engine inoperative requires the down wind leg to be flown in CONF 3, with landing gear extended.

In hot and high conditions and at high landing weight, the aircraft may not be able to maintain level flight in CONF 3 with landing gear down. The flight crew should check the maximum weight showed in the QRH CIRCLING APPROACH WITH ONE ENGINE INOPERATIVE procedure table. If the landing weight is

	<b>ABNORMAL OPERATIONS</b>	03.020
	OPERATING TECHNIQUES	JAN 09/07

above this maximum value, the landing gear extension should be delayed until established on final approach.

If the approach is flown at less than 750 ft RA, the warning "L/G NOT DOWN" will be triggered. "TOO LOW GEAR" warning is to be expected, if the landing gear is not downlocked at 500 ft RA. Therefore, if weather conditions permit, it is recommended to fly a higher circling pattern.

R MSN 0002-0860

### ONE ENGINE INOPERATIVE GO-AROUND

A one engine inoperative go-around is similar to that flown with all engines. On the application of TOGA, rudder must be applied promptly to compensate for the increase in thrust and consequently to keep the beta target centred. Provided the flap lever is selected to Flap 1 or greater, SRS will engage and will be followed. If SRS is not available, the initial target pitch attitude is 12.5°. The lateral FD mode will be GA TRK and this must be considered with respect to terrain clearance. ALT should be selected at the engine inoperative acceleration altitude, with the flap retraction and further climb carried out using the same technique as described earlier in "ENGINE FAILURE AFTER V1" section.

### TWO-ENGINE INOPERATIVE LANDING

	<b>ABNORMAL OPERATIONS</b>	03.020
	OPERATING TECHNIQUES	JAN 09/07

R MSN 0002-0011 0013-0016 0018-0029 0031-0035 0038-0044 0046-0049 0051-0053 0056-0058  
0061 0063 0074-0076 0078-0081 0084-0085 0088-0094 0097 0101 0103-0104 0114-0115 0117  
0123-0126 0128-0131 0133-0137 0139 0141-0142 0145-0147 0149-0152 0154 0156-0161  
0163-0164 0166-0170 0173-0176 0178-0180 0182 0185-0187 0190 0192-0194 0196-0197 0199  
0201-0202 0204 0207-0208 0210 0212-0218 0220-0221 0225 0227-0228 0233 0235-0237  
0239 0242-0243 0245-0246 0252 0257 0260 0263-0264 0268 0270 0273-0274 0278 0280  
0282 0292 0297 0302 0304 0307 0310 0318-0319 0321 0325 0327 0329 0331-0332  
0335 0347 0352 0354-0355 0359 0363 0367 0371 0373-0374 0376-0379 0381 0383 0385  
0387 0390-0391 0394-0395 0399 0402 0406 0410-0411 0413-0417 0424 0426 0429-0431  
0433-0436 0438 0440 0442 0445-0447 0449-0450 0453 0457 0459-0460 0464 0467-0468  
0470-0471 0474-0475 0478 0482-0483 0485 0488 0492 0495 0499 0514 0517 0520 0523  
0528 0531 0534 0537-0538 0540-0541 0543-0547 0554 0556-0557 0559-0563 0566 0569  
0572 0575 0577 0580 0582-0583 0585-0586 0590 0598 0601 0604 0606 0608 0611 0615  
0617 0619 0622 0624 0626 0628 0630 0639 0643 0646 0651 0668 0672 0677 0681 0685  
0689 0694 0698 0702 0706 0710 0715 0719 0723 0727 0731 0736 0740 0744 0748 0753  
0757 0761-0768 0771 0775 0779 0783 0787 0790 0793-0794 0798 0800 0804 0812 0829  
0835 0837 0844 0846 0848

The two-engine inoperative landing is in the scope of the aircraft certification process.

## **PROCEDURE**

Should a two-engine inoperative landing be performed:

- . Fuel jettison should be considered, if time permits
- . A longer than normal straight in approach or a wide visual pattern is preferred
- . During the approach, the packs should be selected off or supplied by the APU to maximize engine thrust.
- . In case of two engines inoperative on the same wing, large thrust variation should be minimized, as it will exacerbate the handling of asymmetric flight.
- . Similarly, Flaps 2 should be selected one dot below GS to minimize thrust variation (or 2000 ft above ground at the latest)
- . Gear down and Flaps 3 selection (or as instructed by the ECAM) should be delayed until established on final approach
- . For final approach, speed will be selected to VLS on PFD. (which equates to VMCL-2 in case of two engines inoperative on the same wing).
- . When committed to land, speed may be managed. The magenta speed target drops to VAPP i.e. below VLS on PFD. The ATHR must be disconnected and the speed reduced to VAPP using manual thrust.



**Note:** In case of 2 engines failed on the same wing, VLS on the PFD takes into consideration VMCL-2 whereas VAPP (displayed in magenta) and MCDU VLS do not take VMCL-2 into consideration.  
In case of landing gear gravity extension (Engines 1+4 failed, or engines 2+3 failed), the commit point will be at gear down selection. In the other cases, it will be when flying below VMCL of the associated configuration on the approach.

**TWO-ENGINE INOPERATIVE FLIGHT PATTERN**

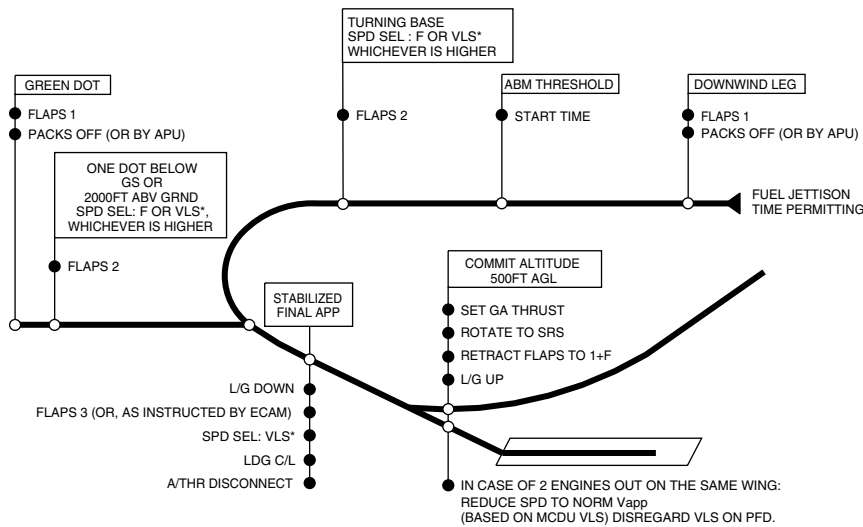

\* FOR 2 ENGINES OUT ON THE SAME WING, VLS SHOWN ON PFD IS LIMITED TO VMCL-2.  
FOR 2 ENGINES OUT ON OPPOSITE WINGS, THE VLS SHOWN ON THE PFD, AS WELL AS ON MCDU, IS LIMITED TO VMCL

CAUTION :  
IF GEAR RETRACTION IS NOT POSSIBLE, DO NOT ATTEMPT A GO-AROUND AFTER LANDING GEAR EXTENSION.

FOF 03020 05086 0001

R (4)

	<b>ABNORMAL OPERATIONS</b>	03.020
	OPERATING TECHNIQUES	JAN 09/07

### HIGHLIGHTS

- (1) The list of factors affecting the rejected takeoff has been completed.
- (2) The ENG OIL LO PR is re-introduced in the list of warnings/cautions which may lead to reject takeoff when above 100 knots, like all the non-inhibited warnings. This alert is re-introduced in the list based on operators feedback in order to ease decision making when at high speed.
- (3) Clarification of Airbus training policy regarding the confirmation of actions on ground.
- (4) Deleted item 'LAND ASAP'

	<b>ABNORMAL OPERATIONS</b>  AUTOFLIGHT	03.022
		JAN 09/07

## FMGC FAILURE

R MSN 0002-0860

### **SINGLE FMGC FAILURE**

Should a single FMGC failure occur, the AP, if engaged on affected side, will disconnect. The AP will be restored using the other FMGC. The A/THR remains operative. Furthermore, flight plan information on the affected ND may be recovered by using same range as the opposite ND. The crew should consider a FMGC reset as detailed in QRH.

### **DUAL FMGC FAILURE**

Should a dual FMGC failure occur, the AP/FD and A/THR will disconnect. The crew will try to recover both AP and A/THR by selecting them back ON (The AP and A/THR can be recovered if the FG parts of the FMGS are still available).

If both AP and A/THR cannot be recovered, the thrust levers will be moved to recover manual thrust. The pilot will switch off the FDs and select TRK / FPA to allow the blue track index and the bird to be displayed. The RMPs will be used to tune the nav aids.

The crew will refer to the QRH for computer reset considerations and then will refer to FCOM 4.06.20 to reload both FMGC as required.

If both FMGC cannot be recovered, the MCDU features a NAV B/UP function which provides simplified IRS based navigation (Refer to FCOM 4). The FPLN is still available as the MCDU continuously memorizes the active flight plan in its internal memory. It should be noted that the FM source selector must be at NORM to allow the NAV/B/UP prompt to be displayed on the MCDU MENU page.

	<b>ABNORMAL OPERATIONS</b>	03.024
	ELECTRICAL	JAN 09/07

## INTRODUCTION TO EMERGENCY ELECTRICAL CONFIGURATION

R MSN 0002-0860

The procedure discussed in this section is the EMERGENCY ELECTRICAL CONFIGURATION. Whilst it is very unlikely that this failure will be encountered, it is useful:

- . To refresh on the technical background
- . To recall the general guidelines that must be followed in such a case
- . To outline the main available systems according to the electrical power source.

## TECHNICAL BACKGROUND

R MSN 0002-0860

The electrical emergency configuration is due essentially to the loss of all main AC BUS which causes the engagement of the emergency generator.

In most cases, this is due to an anomaly on the electrical network, e.g. a short circuit. All engine generators trip and the Emergency Generator is driven by the Engine Driven Pump (EDP). In this scenario, the probability to restore electrical power using the APU generator is low.

An other cause for electrical emergency configuration could be a combination of electrical failures and engine failures. In this scenario, you may restore electrical power using the APU generator.

Depending on which engine (s) is (or are) failed, and on the availability of green hydraulic engine driven pumps, the emergency generator may be driven by the RAT. In this case, it outputs approximately half electrical power of the previous scenario. It should be noted however, that at high speed i.e. above 260 kt IAS, the Emergency Generator electrical power is increased as it takes credit from the engine windmill effect.

However, it must be highlighted that the probability of this last scenario is low. This is why, the summary available in the QRH do not take it into account.

## GENERAL GUIDELINES

	<b>ABNORMAL OPERATIONS</b>	03.024
	ELECTRICAL	JAN 09/07

R MSN 0002-0860

The following guidelines apply whatever the power source is, i.e. EDP or RAT:

As only PFD1 is available, the left hand seat pilot becomes PF. Once a safe flight path is established, and the aircraft is under control, ECAM actions will be carried out.

This is a serious emergency and ATC should be notified using appropriate phraseology (MAYDAY). Although the ECAM displays LAND ASAP in red, it would be unwise to attempt an approach at a poorly equipped airfield in marginal weather. The power source for the Emergency Generator will assist the crews decision making in this context, as the aircraft is in a much better configuration when the Emergency Generator is being powered by the EDP rather than the RAT. In either case however, prolonged flight in this configuration is not recommended.

Crews should be aware that workload is immediately greatly increased.

As only the EWD is available, disciplined use of the ECAM Control Panel (ECP) is essential, (see FCTM Chapter 1- ECAM).

Consideration should be given to starting the APU as indicated by the ECAM and taking into account the probability to restore using APU generator as mentioned above.

A clear reading of STATUS is essential to assess the aircraft status and properly sequence actions during the approach.

The handling of this failure is referred to as a "complex procedure". A summary for handling the procedure is included in the QRH, which will be referred to upon completion of the ECAM procedure.

The ELEC EMER CONFIG SYS REMAINING list is available in QRH.

The LAND RECOVERY pb should be pressed prior to commencing the approach. This action will not be delayed since this will allow the recovery of a number of systems required for landing, e.g. ILS 1, SFCC 1, whilst shedding a number of systems that are no longer required, e.g. the operative fuel pump(s).

The landing gear must be extended by gravity and Nose Wheel Steering is lost in all cases. When the Emergency Generator is powered by EDP, this avoids strong fluctuation of the green hydraulic pressure which may cause a spurious disconnection of the Emergency Generator

#### REMAINING SYSTEMS

R MSN 0012 0017 0030 0037 0045 0050 0054-0055 0059-0060 0062 0064-0073 0077 0082-0083 0086-0087 0095-0096 0098-0100 0102 0106-0113 0116 0118-0122 0127 0132 0138 0140 0143-0144 0148 0153 0155 0162 0165 0171-0172 0177 0181 0183-0184 0188-0189 0191 0195 0198 0200 0203 0205-0206 0209 0211 0219 0222-0224 0226 0229-0232 0234 0238 0240-0241 0244 0247-0251 0253-0256 0258-0259 0261-0262 0265-0267 0269 0271-0272 0275-0277 0279 0281 0283-0291 0293-0296 0299-0301 0303 0305-0306 0308-0309 0311-0317 0320 0322-0324 0326 0328 0330 0333-0334 0337-0346 0348-0351 0353 0356-0358 0361-0362 0364-0366 0368-0370 0372 0375 0380 0382 0384 0386 0388-0389 0392-0393 0396-0398 0400-0401 0403-0405 0407-0409 0412 0418-0423 0425 0427-0428 0432 0437 0439 0441 0443-0444 0448 0451-0452 0454-0456 0458 0461-0463 0465-0466 0469 0472-0473 0476-0477 0479-0481 0484 0486-0487 0489-0491 0493-0494 0496-0498 0500-0513 0515-0516 0518-0519 0521-0522 0524-0527 0529-0530 0532-0533 0535-0536 0539 0542 0548-0553 0555 0558 0564-0565 0567-0568 0570-0571 0573-0574 0576 0578-0579 0581 0584 0587-0588 0591-0597 0600 0602-0603 0605 0607 0609-0610 0612-0614 0616 0618 0620-0621 0623 0625 0627 0629 0631-0638 0640-0642 0644-0645 0647-0650 0652-0667 0669-0671 0673-0676 0678-0680 0682-0684 0686-0688 0690-0693 0695-0697 0699-0701 0703-0705 0707-0709 0711-0714 0716-0718 0720-0722 0724-0726 0728-0730 0732-0735 0737-0739 0741-0743 0745-0747 0749-0752 0754-0756 0758-0760 0769-0770 0772-0774 0776-0778 0780-0782 0784-0786 0788-0789 0791-0792 0795-0797 0799 0801-0803 0805-0811 0813-0828 0830-0834 0836 0838-0843 0845 0847 0849-0860

The electrical distribution has been designed to fly, navigate, communicate and ensure passengers comfort. However, depending on the power source i.e. EDP or RAT, some differences should be outlined:

- Emer Gen powered by the EDP

Significant remaining systems in ELEC EMER CONFIG	
FLY	PFD1, AP1, Pitch trim, rudder trim, alternate law
NAVIGATE	ND1, FMGC1, radar, RMP1, VOR1
COMMUNICATE	VHF1 and HF1

*Note: When the failure occurs, the AP, if engaged, will disengage. AP1 can be reengaged.*

Approach specificities:

When LAND REC is set ON:

- ILS1 and SFCC slat flap channel are recovered
- Direct law when landing gear extended
- Landing is performed with pedal braking and Anti skid

- Emer Gen powered by the RAT

Significant remaining systems in ELEC EMER CONFIG	
FLY	PFD1, Alternate law

	<b>ABNORMAL OPERATIONS</b>  ELECTRICAL	03.024
		JAN 09/07

NAVIGATE	RMP1, VOR1
COMMUNICATE	VHF1

*Note: The AP, pitch trim and rudder trim are not available. The aircraft will be out of trim in roll due to right outboard aileron upfloat and it is necessary to pay close attention to bank angle and heading.*

Approach specificities:

When LAND REC is set ON:

- ILS1 and SFCC slat channel are recovered
- At slat extension, the emergency generator disconnects (in order to dedicate the RAT for flight controls) and landing is performed on Batteries with the same loads.
- Direct law when landing gear extended
- Landing is performed with pedal braking without Anti skid

R MSN 0002-0011 0013-0016 0018-0029 0031-0035 0038-0044 0046-0049 0051-0053 0056-0058 0061 0063 0074-0076 0078-0081 0084-0085 0088-0094 0097 0101 0103-0104 0114-0115 0117 0123-0126 0128-0131 0133-0137 0139 0141-0142 0145-0147 0149-0152 0154 0156-0161 0163-0164 0166-0170 0173-0176 0178-0180 0182 0185-0187 0190 0192-0194 0196-0197 0199 0201-0202 0204 0207-0208 0210 0212-0218 0220-0221 0225 0227-0228 0233 0235-0237 0239 0242-0243 0245-0246 0252 0257 0260 0263-0264 0268 0270 0273-0274 0278 0280 0282 0292 0297 0302 0304 0307 0310 0318-0319 0321 0325 0327 0329 0331-0332 0335 0347 0352 0354-0355 0359 0363 0367 0371 0373-0374 0376-0379 0381 0383 0385 0387 0390-0391 0394-0395 0399 0402 0406 0410-0411 0413-0417 0424 0426 0429-0431 0433-0436 0438 0440 0442 0445-0447 0449-0450 0453 0457 0459-0460 0464 0467-0468 0470-0471 0474-0475 0478 0482-0483 0485 0488 0492 0495 0499 0514 0517 0520 0523 0528 0531 0534 0537-0538 0540-0541 0543-0547 0554 0556-0557 0559-0563 0566 0569 0572 0575 0577 0580 0582-0583 0585-0586 0590 0598 0601 0604 0606 0608 0611 0615 0617 0619 0622 0624 0626 0628 0630 0639 0643 0646 0651 0668 0672 0677 0681 0685 0689 0694 0698 0702 0706 0710 0715 0719 0723 0727 0731 0736 0740 0744 0748 0753 0757 0761-0768 0771 0775 0779 0783 0787 0790 0793-0794 0798 0800 0804 0812 0829 0835 0837 0844 0846 0848

The electrical distribution has been designed to fly, navigate, communicate and ensure passengers comfort. However, depending on the power source i.e. EDP or RAT, some differences should be outlined:

- . mer Gen powered by the EDP

Significant remaining systems in ELEC EMER CONFIG	
FLY	PFD1, Pitch trim, rudder trim, alternate law
NAVIGATE	MCDU1 (B/U NAV), RMP1, VOR1

	<b>ABNORMAL OPERATIONS</b>	03.024
	ELECTRICAL	JAN 09/07

COMMUNICATE	VHF1
-------------	------

*Note: The AP is not available. The rudder trim position indicator on centre pedestal is lost. The aircraft will be out of trim in roll due to right outboard aileron upfloat and it is necessary to pay close attention to bank angle and heading.*

Approach specificities:

When LAND REC is set ON:

- ILS1 and SFCC slat flap channel are recovered
- Direct law when landing gear extended
- Landing is performed with pedal braking without anti skid

. Emer Gen powered by the RAT

Significant remaining systems in ELEC EMER CONFIG	
FLY	PFD1, Alternate law
NAVIGATE	RMP1, VOR1
COMMUNICATE	VHF1

*Note: The AP, pitch trim and rudder trim are not available. The aircraft will be out of trim in roll due to right outboard aileron upfloat and it is necessary to pay close attention to bank angle and heading.*

Approach specificities:

When LAND REC is set ON:

- ILS1 and SFCC slat channel are recovered
- Direct law when landing gear extended
- Landing is performed with pedal braking without anti skid

### RESTORATION FROM EMER ELEC

R MSN 0002-0860

When ELEC EMER CONFIG occurs, the LAND RECOVERY AC and DC BUS bars are initially shed and will remain shed until the LAND REC pb is selected ON. This remains true if normal electrical configuration is restored. This is the reason why the crew will also select LAND REC pb ON for approach following a restoration from an ELEC EMER CONFIG.



	<b>ABNORMAL OPERATIONS</b>	03.026
	FIRE PROTECTION	JAN 09/07

**PREFACE**

R MSN 0002-0860

Fire and/or smoke in the fuselage present the crew with potentially difficult situations. Not only will they have to deal with the emergency itself but also the passengers are likely to panic should they become aware of the situation. It is essential therefore, that action to control the source of combustion is not delayed.

An immediate diversion should be considered as soon as the smoke is detected. If the source is not immediately obvious, accessible and extinguishable, it should be initiated without delay.

**SMOKE DETECTION AND PROCEDURE APPLICATION**

R MSN 0002-0860

The smoke will be identified either by an ECAM warning, or by the crew without any ECAM warning.

If the smoke is detected by the crew, without any ECAM warning, the flight crew will refer directly to the QRH SMOKE/FUMES/AVNCS SMOKE paper procedure.

If the "AVNCS VENT SMOKE "ECAM warning is activated, the flight crew can refer directly to the QRH SMOKE/FUMES/AVNCS SMOKE paper procedure, or apply first the ECAM actions, before entering the QRH. ECAM actions are fully compatible with paper procedure.

If another ECAM SMOKE warning (e.g. LAVATORY SMOKE) is triggered, the flight crew must apply the ECAM procedure. If any doubt exists about the smoke origin, the flight crew will than refer to the QRH SMOKE/FUMES/AVNCS SMOKE paper procedure

SMOKES / FUMES PROCEDURE ARCHITECTURE

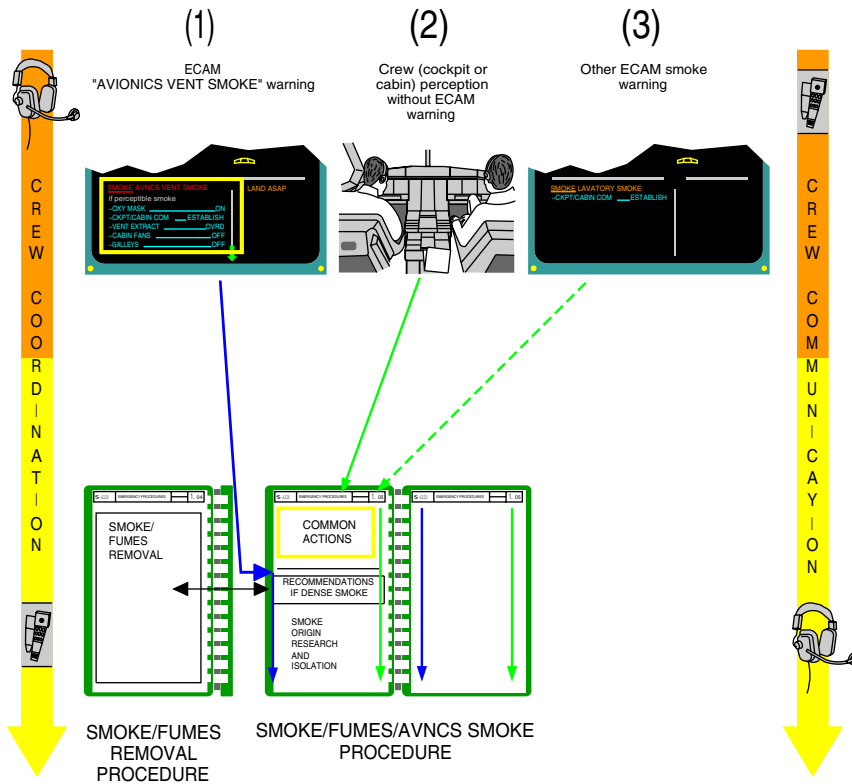

R MSN 0002-0860

	<b>ABNORMAL OPERATIONS</b>	03.026
	FIRE PROTECTION	JAN 09/07

### COORDINATION WITH CABIN CREW

Good coordination between cockpit and cabin crew is a key element .

In case of smoke in the cabin, it is essential that the cabin crew estimate and inform the cockpit concerning the density of smoke and the severity of the situation.

### SMOKE/FUMES/AVNCS SMOKE PAPER PROCEDURE

R MSN 0002-0860

#### **GENERAL**

The SMOKE/FUMES/AVNCS SMOKE paper procedure implements a global philosophy that is applicable to both cabin and cockpit smoke cases. This philosophy includes the following main steps:

- . Diversion to be anticipated
- . Immediate actions
- ▶ If smoke source not immediately isolated:
  - . Diversion initiation
  - . Smoke origin identification and fighting

Furthermore, at any time during the procedure application, if smoke/fumes becomes the greatest threat, the boxed items will be completed.

The main steps of this global philosophy may be visualized in the SMOKE/FUMES/AVNCS SMOKE QRH procedure.

SMOKE/FUMES/AVNCS SMOKE PROCEDURE PRESENTATION IN QRH

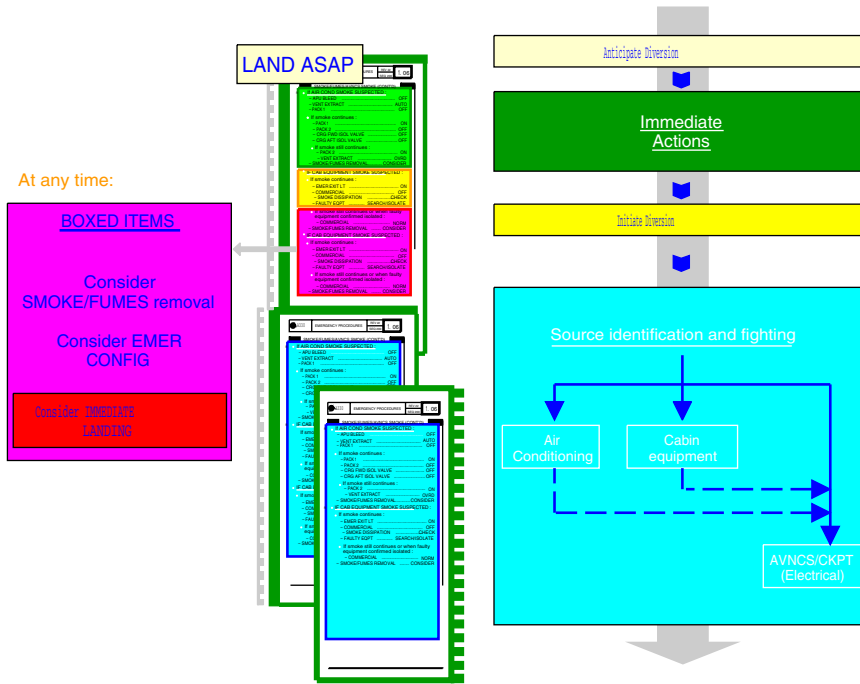

FOF 03034 05090 0001

**CONSIDERATIONS ABOUT DIVERSION**

Time is critical.

This is why a diversion must be immediately anticipated (as indicated by LAND ASAP).

Then, after the immediate actions, if the smoke source cannot immediately identified and isolated, the diversion must be initiated before entering the SMOKE ORIGIN IDENTIFICATION AND FIGHTING part of the procedure.

**IMMEDIATE ACTIONS**

	<b>ABNORMAL OPERATIONS</b>	03.026
	FIRE PROTECTION	JAN 09/07

These actions are common to all cases of smoke and fumes, whatever the source.

Their objectives are:

- . avoiding any further contamination of the cockpit/cabin,
- . communication with cabin crew
- . flight crew protection.

### **SMOKE ORIGIN IDENTIFICATION AND FIGHTING**

The crew tries to identify the smoke source by isolating systems. Some guidelines may help the crew to identify the origin of smoke:

- . If smoke initially comes out of the cockpit's ventilation outlets, or if smoke is detected in the cabin, the crew may suspect an AIR COND SMOKE. In addition, very shortly thereafter, several SMOKE warnings (cargo, lavatory, avionics) will be triggered. The displayed ECAM procedures must therefore be applied.
- . Following an identified ENG or APU failure, smoke may emanate from the faulty item through the bleed system and be perceptible in the cockpit or the cabin. In that case, it will be re-circulated throughout the aircraft, until it completely disappears from the air conditioning system.
- . If only the AVIONICS SMOKE warning is triggered, the crew may suspect an AVIONICS SMOKE.
- . If smoke is detected, while an equipment is declared faulty, the crew may suspect that smoke is coming from this equipment.

According to the source he suspects, the crew will enter one of the 3 paragraphs:

1. IF AIR COND SMOKE SUSPECTED
2. IF CAB EQUIPMENT SMOKE SUSPECTED
3. IF AVNCS/COCKPIT SMOKE SUSPECTED

Since electrical fire is the most critical case, he will also enter paragraph 3 if he doesn't know the source of the smoke, or if the application of paragraph 1 and/or 2 has been unsuccessful.

This part of procedure consists of shedding one side, then the other. If unsuccessful, setting the electrical emergency configuration is the last means to isolate the smoke source.

### **BOXED ITEMS**

	<b>ABNORMAL OPERATIONS</b>	03.026
	FIRE PROTECTION	JAN 09/07

These items (applying SMOKE REMOVAL procedure, setting electrical emergency configuration, or considering immediate landing) may be applied at any time, in the procedure (but not before the immediate actions).

When necessary, the SMOKE REMOVAL procedure must be applied before the electrical emergency configuration is set. Indeed, in electrical emergency configuration SMOKE REMOVAL procedure cannot be applied, since manual control of cabin pressure cannot be selected.

Once the first step of the smoke removal procedure have been applied, the flight crew will come back to the SMOKE/FUMES/AVNCS SMOKE procedure, to apply the appropriate steps, depending on the suspected smoke source while descending to FL 100. Reaching FL 100, the smoke removal procedure will be completed.

### CARGO SMOKE

R MSN 0002-0860

Expect the SMOKE warning to remain after agent discharge, even if the smoke source is extinguished. Gases from the smoke source are not evacuated, and smoke detectors are sensitive to the extinguishing agent, as well. Once isolation valves are closed, the cargo is not ventilated. Thus, the cargo temperature is unreliable.

Order the ground crew not to open the door of the affected cargo compartment, unless passengers have disembarked and fire services are present.

If the SMOKE warning is displayed on ground, with the cargo compartment door open, do not initiate AGENT DISCHARGE. Request that the ground crew investigate and eliminate the smoke source.

On ground, the warning may be triggered due to high level of humidity. Provided the smoke is not visually confirmed :

- . Deactivate the smoke detection system by pulling the SDCU 1 and 2 reset buttons.
- . Reset the cargo ventilation system using the VENT CONT 1 and 2 reset buttons.
- . Upon cargo doors closure, reactivate SDCU 1 and 2.

	<b>ABNORMAL OPERATIONS</b>	03.027
	FLIGHT CONTROLS	JAN 09/07

### ABNORMAL FLAPS/SLATS CONFIGURATION

R MSN 0002-0860

R (1)

#### **CAUSES**

Abnormal operation of the flaps and/or slats may be due to one of the following problems:

- . Double SFCC failure
- . Double hydraulic failure (B+G or Y+G)
- . Flaps/Slats jammed (operation of the WTB)

R (2)

#### **CONSEQUENCES**

Abnormal operation of the flaps and slats has significant consequences since:

- . The control laws may change
- . The selected speed must be used
- . A stabilized approach should be preferred
- . The approach attitudes change
- . Approach speeds and landing distances increase
- . The go-around procedure may have to be modified.

*Note: The FMS prediction do not take into account the slat or flap failures. Since fuel consumption is increased, these predictions are not valid.*

#### **FAILURE AT TAKE-OFF**

Should a flap/slat retraction problem occur at take-off, the crew will PULL the speed knob for selected speed to stop the acceleration and avoid exceeding VFE. The over speed warning is computed according to the actual slats/flaps position.

The landing distance available at the departure airport and the aircraft gross weight will determine the crews next course of action.

#### **FAILURE DURING THE APPROACH**

	<b>ABNORMAL OPERATIONS</b>	03.027
	FLIGHT CONTROLS	JAN 09/07

The detection of a slat or flap failure occurs with the selection of flap lever during the approach. With A/THR operative, the managed speed target will become the next manoeuvring characteristic speed e.g. S speed when selecting flap lever to 1. At this stage, if a slat or flap failure occurs, the crew will:

- . Pull the speed knob for selected speed to avoid further deceleration
- . Delay the approach to complete the ECAM procedure
- . Refer to LANDING WITH FLAPS OR SLATS JAMMED paper check list.
- . Update the approach briefing

In the QRH, the line, "SPEED SEL.....VFE NEXT - 5kt" is designed to allow the crew to configure the aircraft for landing whilst controlling the speed in a safe manner. This procedure may involve reducing speed below the manoeuvring speed for the current configuration which is acceptable provided the speed is kept above VLS. The speed reduction and configuration changes should preferably be carried out wings level.

The landing distance factors and approach speed increments are available in the QRH. See FCTM 03.010

Assuming VLS is displayed on the PFD, VAPP should be close to VLS+ wind correction, since this speed is computed on the actual slat/flap position.

The AP may be used down to 500 ft AGL. As the AP is not tuned for the abnormal configurations, its behaviour can be less than optimum and must be monitored.

During the approach briefing, emphasis should be made of:

- . Tail strike awareness
- . The go-around configuration
- . Any deviation from standard call out
- . The speeds to be flown, following a missed approach
- . At the acceleration altitude, selected speed must be used to control the acceleration to the required speed for the configuration.

Consider the fuel available and the increased consumption associated with a diversion when flying with flaps and/or slats jammed. Additionally, when diverting with flaps/slats extended, cruise altitude is limited 20,000 ft.

### **NO FLAPS NO SLATS LANDING**

Some items in the QRH "NO FLAPS NO SLATS LANDING" checklist need to be highlighted:

- . More distance is required for manoeuvring.



	<b>ABNORMAL OPERATIONS</b>	03.027
	FLIGHT CONTROLS	JAN 09/07

- . The flap handle should be placed into CONF 1 position as required by the QRH to enable the SRS mode in the event of a go-around. VFE displayed on the PFD depends on the flap lever position, so a false VFE will be given.
- . Disregard the CONF 2 requirement on the ECAM the status page.
- . Autopilot is allowed down to 500 feet AGL.
- . At 500 feet, reduce speed to obtain VLS - 5 KT (or VREF + 45 KT, if VLS not available) at touchdown for performance considerations.
- . During the approach the aircraft pitch attitude will be high, increasing the risk of a tail strike on touchdown. Consequently, only a small pitch adjustment is required in the flare to reduce the rate of descent prior to a positive touchdown.
- . Due to the high touchdown speed, a prolonged float should be avoided
- . Braking considerations in FCTM 02.160 apply.

The NO FLAPS NO SLATS LANDING is classified as an extremely improbable failure. It is the reason why the corresponding procedure is not related on ECAM but only on the paper C/L.

R MSN 0002-0860

R (3)

## ELEVATOR REDUNDANCY LOST

### INTRODUCTION

Each ailerons and each elevators are hydraulically powered either by the Green or the Blue or the Yellow circuit and are controlled either by the PRIM or the SEC. This architecture, detailed in QRH /OPS DATA, provides a high level of redundancy.

However, a combination of three failures affecting flight control computers and/or servocontrol and/or hydraulic might lead to the loss of several ailerons and one or both elevators simultaneously. Although the aircraft can be flown in such a configuration, the F/CTL ELEV REDUND LOST procedure (triggered in case of dual failures case) has been developed to anticipate this three failure cases and is designed to smooth the aircraft handling transient.

### TECHNICAL BACKGROUND

- R (4)
- R (5)
- R (6)
- R (7)

**FLIGHT CONTROL ARCHITECTURE AND FAILURES**

For a clear understanding, we will study the following example: Loss of the green hydraulic system and PRIM 2, which triggers the F/CTL ELEV REDUND LOST procedure, followed by a SEC2 failure.

- R (8)

NORMAL SITUATION (BEFORE ANY FAILURE)

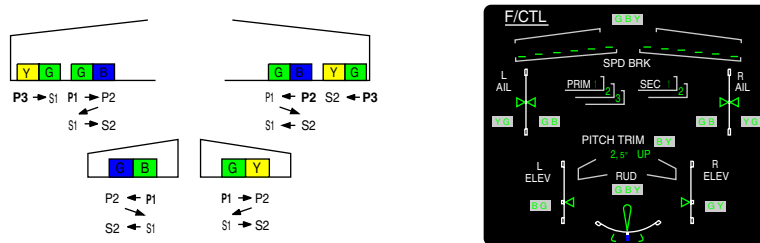

FOF 03027 03764 0001

- R (9)

GREEN HYDRAULIC LOSS (FIRST FAILURE)

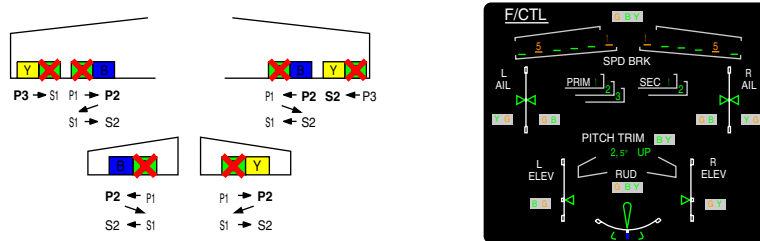

FOF 03027 03765 0001

Green hydraulic power is lost. Flight controls computers switch allows the ailerons and elevators to be recovered.

R (10)

PRIM 2 LOSS (SECOND FAILURE)

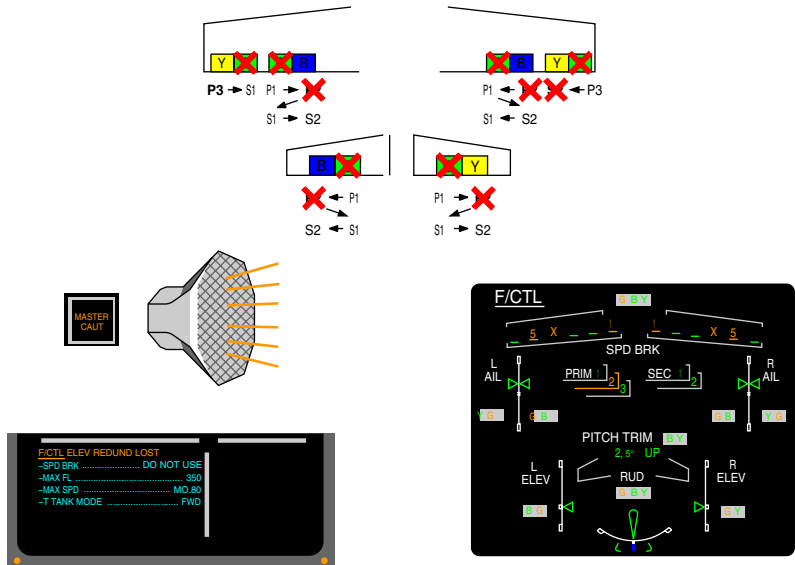

FOF 03027 03766 0001

The **F/CTL ELEV REDUND LOST** procedure is triggered at this stage (when two failures occur). The crew should note that, at this stage, both elevators and all ailerons are available.

R (11)

SEC 2 LOSS (THIRD FAILURE)

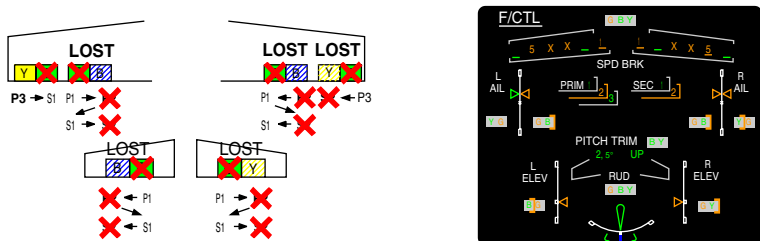

FOF 03027 03767 0001

At this stage, both elevators are lost and only left outboard aileron is available.

	<b>ABNORMAL OPERATIONS</b>	03.027
	FLIGHT CONTROLS	JAN 09/07

## FAILED AILERON BEHAVIOUR

When an aileron is failed (due to failure of its hydraulic supply and/or electrical control and/or servojack), it goes to its zero hinge moment corresponding to around 14° up. This produces a loss of lift which creates a pitch up moment. The elevators, when available, compensate this effect.

- For the cases where three consecutive failures affecting flight controls lead to the simultaneous loss of both elevators and some ailerons, a 12° upwards aileron preset is anticipated (before the third failure) and the resulting pitch up effect can be compensated by the elevators (which are available at this stage) and then trimmed by the THS. This 12° upwards aileron preset is a compromise between fuel consumption increase (around 16%) and the pitch up effect at the time of the third failure. This aileron preset is displayed on ECAM FCTL page.

If the third and dimensioning failure occurs, three ailerons and both elevators are lost. The failed ailerons go to their zero hinge moment (14° up). As the ailerons were previously preset upwards (12° up), the transient is smooth. Only a slight upward movement occur but is controllable through the THS. MAN PITCH TRIM ONLY is displayed on the top of PFD.

- For the cases where three consecutive failures affecting flight controls may lead to the simultaneous loss of **one** elevator and some ailerons, **no aileron-preset** anticipation is required. This can be visualized on ECAM FCTL page. If the third and dimensioning failure occurs, the remaining elevator compensates the pitch up effect.

## PROCEDURE GUIDELINES

Depending on the combination of failures, the AP might be not available. Indeed, in case of ailerons preset, the AP behaviour is less than optimum and automatically disconnects.

Below 2000 ft or when in Conf 2 however, the aileron preset is cancelled to facilitate the landing manoeuvre and permit the use of AP if available.

The ELEV REDUND LOST procedure requires both speed and FL limitations:

- The speed limitation is introduced to cope with aircraft structure effort, should a third dimensioning failure occur.
- The FL limitation is introduced to maintain stabilizer authority, should a third dimensioning failure occur.

LDG CONF- APPR SPD - LDG DIST corrections for failures in QRH must be referred. As F/CTL ELEV REDUND LOST is a result of a multiple failures, refer to the use of tables for multiple failure memo.

	<b>ABNORMAL OPERATIONS</b>	03.027
	FLIGHT CONTROLS	JAN 09/07

The decision to divert remains at captain's discretion and is mainly linked to the moment where the failure occurs and to operational considerations such as maintenance, passengers' convenience....

The aft CG warning is generated by the Flight Envelope (FE) computer as a function of the THS position. In case of aileron preset, the THS position counteracts the pitch up effect inducing an erroneous CG computation. This is why any aft CG warning should be disregarded. CG, computed by the FCMC and displayed on ECAM, remains reliable (See FCTM 4.04)

If a third dimensioning failure occurs leading to the loss of both elevators:

- . The aircraft longitudinal control is ensured through MAN PITCH TRIM ONLY
- . The A/THR may be disconnected to limit engine acceleration/deceleration thus facilitating the aircraft longitudinal control.
- . The FL and speed limitations no longer apply

	<b>ABNORMAL OPERATIONS</b>	03.027
	<b>FLIGHT CONTROLS</b>	JAN 09/07

<b>HIGHLIGHTS</b>
-------------------

- (1) Harmonization with FCOM and QRH
- (2) Addition of information regarding the FMS predictions.
- (3) Illustration is enhanced, for correct description of the hydraulic power
- (4) Deleted item 'Normal situation (before any failure)'
- (5) Deleted item 'Green hydraulic loss (first failure)'
- (6) Deleted item 'PRIM 2 loss (Second failure)'
- (7) Deleted item 'SEC 2 loss (third failure)'
- (8) New item 'Normal situation (before any failure)' for 'MSN 0002-0860'
- (9) New item 'Green hydraulic loss (first failure)' for 'MSN 0002-0860'
- (10) New item 'PRIM 2 loss (Second failure)' for 'MSN 0002-0860'
- (11) New item 'SEC 2 loss (third failure)' for 'MSN 0002-0860'

	<b>ABNORMAL OPERATIONS</b>	03.028
	FUEL	JAN 09/07

### FUEL LEAK

R MSN 0002-0860

Significant fuel leaks although rare, are sometimes difficult to detect. Fuel check will be carried out by:

- . Checking that the remaining fuel added to the burnt fuel corresponds to the fuel on board at the gate.
- . Maintaining the fuel log and comparing fuel on board to expected flight plan fuel would alert the crew to any discrepancy.

Fuel checks should be carried out when sequencing a waypoint and at least every 30 minutes. Any discrepancy should alert the crew and investigation should be carried out without delay.

Any time an unexpected fuel quantity indication, ECAM fuel message or imbalance is noted, a fuel leak should be considered as a possible cause. Initial indications should be carefully cross-checked by reference to other means, including if possible, a visual inspection.

If a leak is suspected, the crew should action the "FUEL LEAK" abnormal checklist available in QRH:

- . If leak is positively identified as coming from engine, the affected engine is shut down to isolate the fuel leak and fuel cross-feed valve(s) may be used as required.
- . If the leak is not from the engines or cannot be located, it is imperative that the cross-feed valve(s) is (are) not opened.

	<b>ABNORMAL OPERATIONS</b>	03.029
	HYDRAULIC	JAN 09/07

## HYDRAULIC GENERATION PARTICULARITIES

R MSN 0002-0860

### **PREFACE**

The hydraulic generation may come from:

- . The engine driven pumps
- . The RAT
- . The electrical pumps
- . The hand pump

RAT and electrical pumps have some particularities that need to be highlighted.

### **RAT**

The RAT may be extended manually by pressing the RAT MAN ON pushbutton or may deploy automatically.

The RAT is designed to supply flight controls and the Emergency Generator e.g. in all engines flame out case. It can cover high transient demand from flight controls.

The RAT deploys automatically in the event of:

- . All engines flame out
- . In some cases of dual hydraulic LO LVL (See FCOM 1.29.10)

The dual hydraulic LO LVL signal is used for the RAT automatic deployment logics. The purpose of these logics is to cover the case of an engine burst affecting several hydraulic lines. It should be noted that, even in case of the green hydraulic circuit LO LVL, the RAT could pressurize the green hydraulic circuit.

The RAT flow varies between 15 % and 45 % of an engine driven pump flow capability according to the aircraft speed.

RAT must not be used in case of green hydraulic overheat.

At low speed, the RAT stalls. Some anticipation is required from the crew to carry out a safe landing.

### **ELECTRICAL PUMPS**

These electrical pumps are not designed to replace the Engine Driven Pump to supply flight controls, as they are power limited (the hydraulic electric pump flow represents 18% of an engine driven pump flow) and they cannot cover high



	<b>ABNORMAL OPERATIONS</b>	03.029
	HYDRAULIC	JAN 09/07

transient demand from flight controls. Furthermore, if they were used in case of dual hydraulic failure, they could degrade the aircraft handling (Flight Control jerk).

As a general rule, do not manually select a HYD ELEC PUMP ON, except temporarily, to retract the spoilers if they remain out after a hydraulic failure.

## DUAL HYDRAULIC FAILURES

R MSN 0002-0860

R (1)

### PREFACE

Single hydraulic failures have very little effect on the handling of the aircraft but will cause a degradation of the landing capability to Cat 3 Single. Dual hydraulic failures however, although unlikely, are significant due to the following consequences:

- . Loss of AP
- . Flight control law degradation (F/CTL PROT)
- . Landing in abnormal configuration
- . Extensive ECAM procedures with associated workload and task-sharing considerations
- . Significant considerations for approach, landing and go-around.

### GENERAL GUIDELINES

It is important to note that the AP will not be available to the crew but both FD and A/THR still remain. Additionally, depending on the affected hydraulic circuits, aircraft handling characteristics may be different due to the loss of some control surfaces. The PF will maneuver with care to avoid high hydraulic demand on the remaining system.

The PF will be very busy flying the aircraft and handling the communications with the flight controls in Alternate Law.

A double hydraulic failure is an emergency situation, with red LAND ASAP displayed, and a MAYDAY should be declared to ATC. A landing must be carried out as soon as possible bearing in mind, however, that the ECAM actions should be completed prior the approach.

	<b>ABNORMAL OPERATIONS</b>	03.029
	HYDRAULIC	JAN 09/07

PF will then require the ECAM actions. A clear reading of STATUS is essential to assess the aircraft status and properly sequence actions during the approach.

This failure is called a "complex procedure" and the QRH summary should be referred to upon completion of the ECAM procedure. See FCTM 01.040 USE OF SUMMARIES.

While there is no need to remember the following details, an understanding of the structure of the hydraulic and flight control systems would be an advantage. The F/CTL SD page and the Ops Data section of the QRH provide an overview of the flight controls affected by the loss of hydraulic systems.

The briefing will concentrate on safety issues since this will be a hand flown approach with certain handling restrictions:

- . Use of the selected speeds on the FCU.
- . Landing gear gravity extension
- . Approach configuration and flap lever position
- . Approach speed VAPP
- . A stabilized approach will be preferred
- . Tail strike awareness
- . Braking and steering considerations
- . Go around call out, aircraft configuration and speed

<b>REMAINING SYSTEMS</b>
--------------------------

R MSN 0012 0017 0050 0060 0062 0064-0069 0071-0073 0077 0082-0083 0087 0095-0096 0098-0100 0102 0106-0113 0116 0118-0122 0127 0132 0138 0140 0143-0144 0148 0153 0155 0162 0165 0171-0172 0177 0181 0195 0206 0209 0219 0222-0224 0226 0229-0232 0234 0238 0240-0241 0244 0247-0251 0253-0256 0258-0259 0261-0262 0265-0267 0271 0275-0277 0279 0281 0283-0291 0293-0296 0299-0301 0303 0305-0306 0308-0309 0311-0317 0320 0322-0324 0326 0328 0333-0334 0337-0338 0340-0346 0348-0351 0353 0356-0358 0361-0362 0364-0366 0368-0370 0372 0375 0380 0382 0384 0386 0388-0389 0392-0393 0396 0398 0400-0401 0403-0405 0407-0409 0412 0418-0421 0423 0425 0427-0428 0432 0437 0439 0444 0451-0452 0454-0456 0461-0462 0469 0476 0479-0480 0484 0490-0491 0493-0494 0496-0497 0501 0505 0509 0512 0515 0518 0524-0527 0529 0532-0533 0536 0539 0542 0548-0552 0565 0568 0570 0576 0578-0579 0581 0588 0591 0597 0600 0609-0610 0614 0618 0620-0621 0625 0627 0629 0631-0633 0635-0636 0640 0642 0645 0648-0649 0652 0654 0656 0658 0662-0666 0669-0670 0673-0674 0676 0679 0683 0687-0688 0690 0692 0696 0701 0708-0709 0713 0716-0718 0720 0722 0724 0726 0728-0730 0732 0735 0737 0739 0741 0750-0751 0756 0758-0759 0772-0773 0776-0778 0780-0782 0784-0786 0788 0791 0795-0797 0799 0802-0803 0806-0810 0815-0818 0821-0822 0824 0827-0828 0830 0832-0833 0836 0839-0840 0843 0845 0850-0852 0854-0860

R (2)

Flight phase	Systems	Remaining systems		
		HYD G+B SYS LO PR	HYD G+Y SYS LO PR	HYD B+Y SYS LO PR
Cruise	Auto pilot	Inop	Inop	Inop
	Control law	ALTN LAW	ALTN LAW	ALTN LAW
	Stabilizer	Avail	Avail	Inop(2)
	Spoilers	2 SPLRS/wing	2 SPLRS/wing	2 SPLRS/wing
	Elevator	R ELEV only	L ELEV only	Avail
	Aileron	L+R OUTR AIL only	L+R INR AILonly	Avail
Landing	Slats/Flaps	FLAPS slow only	SLATS slow only	SLATS/FLAPS slow
	L/G extension	Gravity	Gravity	Gravity (3)
	Braking	ACCU only(1)	ALTN BRK only	NORM BRKonly
	Anti skid	Inop	Avail	Avail
	Nose wheel steering	Inop	Inop	Inop
	Reverse	REV 2 only	REV 1 only	Inop
Go/around	L/G retraction	Inop	Inop	Inop

1. After stopping, the parking brake may be inoperative due to low blue system accumulator pressure.
2. The elevators remain operative and the auto trim function remains available through the elevators
3. For approach, landing gear will be extended by gravity to preserve green system integrity for flight controls.

R MSN 0030 0037 0045 0054-0055 0059 0070 0086 0183-0184 0188-0189 0191 0198 0200 0203 0205 0211 0269 0272 0330 0339 0397 0422 0441 0443 0448 0458 0463 0465-0466 0472-0473 0477 0481 0486-0487 0489 0498 0500 0502-0504 0506-0508 0510-0511 0513 0516 0519 0521-0522 0530 0535 0553 0555 0558 0564 0567 0571 0573-0574 0584 0587 0593-0595 0602-0603 0605 0607 0612 0616 0623 0634 0637-0638 0641 0644 0647 0650 0653 0655 0657 0659-0661 0667 0671 0675 0678 0680 0682 0684 0686 0691 0693 0695 0697 0699-0700 0703-0705 0707 0711-0712 0714 0721 0725 0733-0734 0738 0742-0743 0745-0747 0749 0752 0754-0755 0760 0769-0770 0774 0789 0792 0801 0805 0811 0813-0814 0819-0820 0823 0825-0826 0831 0834 0838 0841-0842 0847 0849 0853

		Remaining systems		
Flight phase	Systems	HYD G+B SYS LO PR	HYD G+Y SYS LO PR	HYD B+Y SYS LO PR
Cruise	Auto pilot	Inop	Inop	Inop
	Control law	ALTN LAW	ALTN LAW	ALTN LAW
	Stabilizer	Avail	Avail	Inop (2)
	Spoilers	2 SPLRS/wing	2 SPLRS/wing	2 SPLRS/wing
	Elevator	R ELEV only	L ELEV only	Avail
	Aileron	L+R OUTF AIL only	L+R INR AIL only	Avail
Landing	Slats/Flaps	FLAPS slow only	SLATS slow only	SLATS/FLAPS slow
	L/G extension	Gravity	Gravity	Gravity(3)
	Braking	B ACCU PRESS only	ALTN BRK only	NORM BRK only
	Anti skid	Inop	Avail	Avail
	Nose wheel steering	Inop	Inop	Inop
	Reverse	Avail	Avail	Avail
Go/around	L/G retraction	Inop	Inop	Inop

1. After stopping, the parking brake may be inoperative due to low blue system accumulator pressure.
2. The elevators remain operative and the auto trim function remains available through the elevators
3. For approach, landing gear will be extended by gravity to preserve green system integrity for flight controls.

R MSN 0002-0011 0013-0016 0018-0029 0031-0035 0038-0044 0046-0049 0051-0053 0056-0058 0061 0063 0074-0076 0078-0081 0084-0085 0088-0094 0097 0101 0103-0104 0114-0115 0117 0123-0126 0128-0131 0133-0137 0139 0141-0142 0145-0147 0149-0152 0154 0156-0161 0163-0164 0166-0170 0173-0176 0178-0180 0182 0185-0187 0190 0192-0194 0196-0197 0199 0201-0202 0204 0207-0208 0210 0212-0218 0220-0221 0225 0227-0228 0233 0235-0237 0239 0242-0243 0245-0246 0252 0257 0260 0263-0264 0268 0270 0273-0274 0278 0280 0282 0292 0297 0302 0304 0307 0310 0318-0319 0321 0325 0327 0329 0331-0332 0335 0347 0352 0354-0355 0359 0363 0367 0373-0374 0377-0379 0381 0385 0387 0390 0395 0399 0402 0406 0411 0413-0415 0424 0429-0430 0433-0435 0438 0442 0446-0447 0450 0459 0467 0470 0474 0483 0528 0538 0541 0544-0546 0554 0556 0559 0561-0562 0582 0585 0590 0598 0643 0646 0651 0668 0793 0800 0835 0844

		Remaining systems		
Flight phase	Systems	HYD G+B SYS LO PR	HYD G+Y SYS LO PR	HYD B+Y SYS LO PR
Cruise	Auto pilot	Inop	Inop	Inop
	Control law	ALTN LAW	ALTN LAW	ALTN LAW
	Stabilizer	Avail	Avail	Inop(2)
	Spoilers	2 SPLRS/wing	2 SPLRS/wing	2 SPLRS/wing
	Elevator	R ELEV only	L ELEV only	Avail
	Aileron	L+R OUTR AIL only	L+R INR AIL only	Avail
Landing	Slats/Flaps	FLAPS slowly	SLATS slowly	SLATS/FLAPS slow only
	L/G extension	Gravity	Gravity	Gravity(3)
	Braking	B ACCU PRESS only(1)	ALTN BRK only	NORM BRK only
	Anti skid	Inop	Avail	Avail
	Nose wheel steering	Inop	Inop	Inop
	Reverse	REV 3 only	REV 2 only	REV 1+ 4 only

Go/around	L/G retraction	Inop	Inop	Inop (3)
-----------	----------------	------	------	----------

1. After stopping, the parking brake may be inoperative due to low blue system accumulator pressure.
2. The elevators remain operative and the auto trim function remains available through the elevators
3. For approach, landing gear will be extended by gravity to preserve green system integrity for flight controls.

R MSN 0371 0376 0383 0391 0394 0410 0416-0417 0426 0431 0436 0440 0445 0449 0453  
0457 0460 0464 0468 0471 0475 0478 0482 0485 0488 0492 0495 0499 0514 0517 0520  
0523 0531 0534 0537 0540 0543 0547 0557 0560 0563 0566 0569 0572 0575 0577 0580  
0583 0586 0601 0604 0606 0608 0611 0615 0617 0619 0622 0624 0626 0628 0630 0639  
0672 0677 0681 0685 0689 0694 0698 0702 0706 0710 0715 0719 0723 0727 0731 0736  
0740 0744 0748 0753 0757 0761-0768 0771 0775 0779 0783 0787 0790 0794 0798 0804  
0812 0829 0837 0846 0848

		Remaining systems		
Flight phase	Systems	HYD G+B SYS LO PR	HYD G+Y SYS LO PR	HYD B+Y SYS LO PR
Cruise	Auto pilot	Inop	Inop	Inop
	Control law	ALTN LAW	ALTN LAW	ALTN LAW
	Stabilizer	Avail	Avail	Inop (1)
	Spoilers	2 SPLRS/wing	2 SPLRS/wing	2 SPLRS/wing
	Elevator	R ELEV only	L ELEV only	-
	Aileron	L+R OUTR AIL only	L+R INR AIL only	Avail
Landing	Slats/Flaps	FLAPS slow only	SLATS slowly	SLATS/FLAPS slow only
	L/G extension	Gravity	Gravity	Gravity (2)
	Braking	B ACCU PRESSonly	ALTN BRK only	Avail
	Anti skid	Inop	Avail	Avail
	Nose wheel steering	Avail	Inop	Avail
	Reverse	REV 3 only	REV 2 only	REV 1+ 4 only
Go/around	L/G retraction	Inop	Inop	Inop

	<b>ABNORMAL OPERATIONS</b>	03.029
	HYDRAULIC	JAN 09/07

1. The elevators remain operative and the auto trim function remains available through the elevators
2. For approach, landing gear will be extended by gravity to preserve green system integrity for flight controls.

	<b>ABNORMAL OPERATIONS</b>	03.029
	HYDRAULIC	JAN 09/07

**HIGHLIGHTS**

- (1) Reference corrected
- (2) Correction of remaining systems in case of G+Y SYS LO PR



	<b>ABNORMAL OPERATIONS</b>	03.032
	LANDING GEAR	JAN 09/07

**LDG WITH ABNORMAL L/G**

R MSN 0012 0017 0030 0037 0045 0050 0054-0055 0059-0060 0062 0064-0073 0077  
0082-0083 0086-0087 0095-0096 0098-0100 0102 0106-0113 0116 0118-0122 0127 0132 0138  
0140 0143-0144 0148 0153 0155 0162 0165 0171-0172 0177 0181 0183-0184 0188-0189  
0191 0195 0198 0200 0203 0205-0206 0209 0211 0219 0222-0224 0226 0229-0232 0234  
0238 0240-0241 0244 0247-0251 0253-0256 0258-0259 0261-0262 0265-0267 0269 0271-0272  
0275-0277 0279 0281 0283-0291 0293-0296 0299-0301 0303 0305-0306 0308-0309 0311-0317  
0320 0322-0324 0326 0328 0330 0333-0334 0337-0346 0348-0351 0353 0356-0358 0361-0362  
0364-0366 0368-0370 0372 0375 0380 0382 0384 0386 0388-0389 0392-0393 0396-0398  
0400-0401 0403-0405 0407-0409 0412 0418-0423 0425 0427-0428 0432 0437 0439 0441  
0443-0444 0448 0451-0452 0454-0456 0458 0461-0463 0465-0466 0469 0472-0473 0476-0477  
0479-0481 0484 0486-0487 0489-0491 0493-0494 0496-0498 0500-0513 0515-0516 0518-0519  
0521-0522 0524-0527 0529-0530 0532-0533 0535-0536 0539 0542 0548-0553 0555 0558  
0564-0565 0567-0568 0570-0571 0573-0574 0576 0578-0579 0581 0584 0587-0588 0591-0597  
0600 0602-0603 0605 0607 0609-0610 0612-0614 0616 0618 0620-0621 0623 0625 0627  
0629 0631-0638 0640-0642 0644-0645 0647-0650 0652-0667 0669-0671 0673-0676 0678-0680  
0682-0684 0686-0688 0690-0693 0695-0697 0699-0701 0703-0705 0707-0709 0711-0714  
0716-0718 0720-0722 0724-0726 0728-0730 0732-0735 0737-0739 0741-0743 0745-0747  
0749-0752 0754-0756 0758-0760 0769-0770 0772-0774 0776-0778 0780-0782 0784-0786  
0788-0789 0791-0792 0795-0797 0799 0801-0803 0805-0811 0813-0828 0830-0834 0836  
0838-0843 0845 0847 0849-0860

R (1) (2)

This situation might occur following completion of a L/G GEAR NOT DOWNLOCKED procedure. It is always better to land with any available gear rather than carry out a landing without any gear.

In all cases, weight should be reduced as much as possible to provide the slowest possible touchdown speed. Although foaming of the runway is not a requirement, full advantage should be taken of any ATC offer to do so.

The passengers and cabin crew should be informed of the situation in good time. This will allow the cabin crew to prepare the cabin and perform their emergency landing and evacuation procedures.

If one or both main landing gears in abnormal position, the ground spoilers will not be armed to keep as much roll authority as possible for maintaining the wings level. Ground spoiler extension would prevent spoilers from acting as roll surfaces.

The crew will not arm the autobrake as manual braking will enable better pitch and roll control. Furthermore, with at least one main landing gear in the abnormal position, the autobrake cannot be activated (ground spoilers not armed).

With one main landing gear not extended, the reference speed used by the anti-skid system is not correctly initialized. Anti-skid operation might be affected, and consequently, the anti-skid must be switched off.

In all cases, a normal approach should be flown and control surfaces used as required to maintain the aircraft in a normal attitude for as long as possible after touchdown. The engines should be shut down early enough to ensure that fuel is

	<b>ABNORMAL OPERATIONS</b>  LANDING GEAR	03.032
		JAN 09/07

cut off prior to nacelle touchdown, but late enough to keep sufficient authority on control surfaces in order to:

- . Maintain runway axis
- . Prevent nacelle contact on first touch down
- . Maintain wing level and pitch attitude as long as possible.

Considering a realistic hydraulic demand, the hydraulic power remains available up to approximately 30 seconds after the shut down of the related engine. It is the reason why the recommendations to switch the ENG masters OFF are as follow:

- . If NOSE L/G abnormal  
Before nose impact
- . If one MAIN L/G abnormal  
failure side engine: After main gear touch down  
other engine: Before nacelle touch down
- . If both MAIN L/G abnormal  
In the flare, before touch down

The reversers will not be used to prevent the ground spoilers extension and because the engine will touch the ground during roll out.

The engines and APU fire pbs are pushed when the use of flight controls is no longer required i.e. when aircraft has stopped.

MSN 0002-0011 0013-0016 0018-0029 0031-0035 0038-0044 0046-0049 0051-0053 0056-0058  
 0061 0063 0074-0076 0078-0081 0084-0085 0088-0094 0097 0101 0103-0104 0114-0115 0117  
 0123-0126 0128-0131 0133-0137 0139 0141-0142 0145-0147 0149-0152 0154 0156-0161  
 0163-0164 0166-0170 0173-0176 0178-0180 0182 0185-0187 0190 0192-0194 0196-0197 0199  
 0201-0202 0204 0207-0208 0210 0212-0218 0220-0221 0225 0227-0228 0233 0235-0237  
 0239 0242-0243 0245-0246 0252 0257 0260 0263-0264 0268 0270 0273-0274 0278 0280  
 0282 0292 0297 0302 0304 0307 0310 0318-0319 0321 0325 0327 0329 0331-0332  
 0335 0347 0352 0354-0355 0359 0363 0367 0371 0373-0374 0376-0379 0381 0383 0385  
 0387 0390-0391 0394-0395 0399 0402 0406 0410-0411 0413-0417 0424 0426 0429-0431  
 0433-0436 0438 0440 0442 0445-0447 0449-0450 0453 0457 0459-0460 0464 0467-0468  
 0470-0471 0474-0475 0478 0482-0483 0485 0488 0492 0495 0499 0514 0517 0520 0523  
 0528 0531 0534 0537-0538 0540-0541 0543-0547 0554 0556-0557 0559-0563 0566 0569  
 0572 0575 0577 0580 0582-0583 0585-0586 0590 0598 0601 0604 0606 0608 0611 0615  
 0617 0619 0622 0624 0626 0628 0630 0639 0643 0646 0651 0668 0672 0677 0681 0685  
 0689 0694 0698 0702 0706 0710 0715 0719 0723 0727 0731 0736 0740 0744 0748 0753  
 0757 0761-0768 0771 0775 0779 0783 0787 0790 0793-0794 0798 0800 0804 0812 0829  
 0835 0837 0844 0846 0848

R (3)

This situation might occur following completion of a L/G GEAR NOT DOWNLOCKED procedure. It is always better to land with any available gear rather than carry out a landing without any gear. The exception to this is the

	<b>ABNORMAL OPERATIONS</b>	03.032
	LANDING GEAR	JAN 09/07

A340, when it is prohibited to extend the center gear with one main landing gear not fully extended. The center landing gear structure is not designed to sustain the aircraft weight, in case of main landing gear abnormal configuration. That's the reason why, as per design, the center landing gear does not extend in case of landing gear gravity extension. Indeed, the gravity extension logic has been developed by taking into account an abnormal main landing gear position, following a gravity extension.

In all cases, weight should be reduced as much as possible to provide the slowest possible touchdown speed. Although foaming of the runway is not a requirement, full advantage should be taken of any ATC offer to do so.

The passengers and cabin crew should be informed of the situation in good time. This will allow the cabin crew to prepare the cabin and perform their emergency landing and evacuation procedures.

If one or both main landing gears in abnormal position, the ground spoilers will not be armed to keep as much roll authority as possible for maintaining the wings level. Ground spoiler extension would prevent spoilers from acting as roll surfaces.

The crew will not arm the autobrake as manual braking will enable better pitch and roll control. Furthermore, with at least one main landing gear in the abnormal position, the autobrake cannot be activated (ground spoilers not armed).

On A340-200/300, with one main landing gear not extended, the reference speed used by the anti-skid system is not correctly initialized. Anti-skid operation might be affected, and consequently, the anti-skid must be switched off.

In all cases, a normal approach should be flown and control surfaces used as required to maintain the aircraft in a normal attitude for as long as possible after touchdown. The engines should be shut down early enough to ensure that fuel is cut off prior to nacelle touchdown, but late enough to keep sufficient authority on control surfaces in order to:

- . Maintain runway axis
- . Prevent nacelle contact on first touch down
- . Maintain wing level and pitch attitude as long as possible.

Considering a realistic hydraulic demand, the hydraulic power remains available up to approximately 30 seconds after the shut down of the related engine. It is the reason why the recommendations to switch the ENG masters OFF are as follow:

- . If NOSE L/G abnormal  
Before nose impact
- . If one MAIN L/G abnormal  
Outboard engines: After main gear touch down  
Inboard engines (failure side first): Before nacelle touch down
- . If both MAIN L/G abnormal

	<b>ABNORMAL OPERATIONS</b>	03.032
	LANDING GEAR	JAN 09/07

In the flare, before touch down

The reversers will not be used to prevent the ground spoilers extension and because the engine will touch the ground during roll out.

The engines and APU fire pbs are pushed when the use of flight controls is no longer required i.e. when aircraft has stopped.

	<b>ABNORMAL OPERATIONS</b>	03.032
	LANDING GEAR	JAN 09/07

<b>HIGHLIGHTS</b>
-------------------

- (1) removal of the information relative to the A340
- (2) the ON GROUND EMER EVACUATION checklist is not to be carried out, as all the steps are included in the LDG WITH ABNORMAL L/G checklist.
- (3) New item 'LDG WITH ABNORMAL L/G' for 'MSN 0002-0011 0013-0016 0018-0029 0031-0035 0038-0044 0046-0049 0051-0053 0056-0058 0061 0063 0074-0076 0078-0081 0084-0085 0088-0094 0097 0101 0103-0104 0114-0115 0117 0123-0126 0128-0131 0133-0137 0139 0141-0142 0145-0147 0149-0152 0154 0156-0161 0163-0164 0166-0170 0173-0176 0178-0180 0182 0185-0187 0190 0192-0194 0196-0197 0199 0201-0202 0204 0207-0208 0210 0212-0218 0220-0221 0225 0227-0228 0233 0235-0237 0239 0242-0243 0245-0246 0252 0257 0260 0263-0264 0268 0270 0273-0274 0278 0280 0282 0292 0297 0302 0304 0307 0310 0318-0319 0321 0325 0327 0329 0331-0332 0335 0347 0352 0354-0355 0359 0363 0367 0371 0373-0374 0376-0379 0381 0383 0385 0387 0390-0391 0394-0395 0399 0402 0406 0410-0411 0413-0417 0424 0426 0429-0431 0433-0436 0438 0440 0442 0445-0447 0449-0450 0453 0457 0459-0460 0464 0467-0468 0470-0471 0474-0475 0478 0482-0483 0485 0488 0492 0495 0499 0514 0517 0520 0523 0528 0531 0534 0537-0538 0540-0541 0543-0547 0554 0556-0557 0559-0563 0566 0569 0572 0575 0577 0580 0582-0583 0585-0586 0590 0598 0601 0604 0606 0608 0611 0615 0617 0619 0622 0624 0626 0628 0630 0639 0643 0646 0651 0668 0672 0677 0681 0685 0689 0694 0698 0702 0706 0710 0715 0719 0723 0727 0731 0736 0740 0744 0748 0753 0757 0761-0768 0771 0775 0779 0783 0787 0790 0793-0794 0798 0800 0804 0812 0829 0835 0837 0844 0846 0848'

	<b>ABNORMAL OPERATIONS</b>  NAVIGATION	03.034
		JAN 09/07

### ADR/IRS FAULT

R MSN 0002-0860

R (1)

Each ADIRS has two parts (ADR and IRS), that may fail independently of each other. Additionally the IRS part may fail totally or may be available in ATT mode.

Single NAV ADR FAULT or NAV IRS FAULT are simple procedures, and only require action on the switching panel as indicated by the ECAM.

Dual NAV ADR or NAV IRS failures will cause the loss of AP, A/THR and flight controls revert to ALTN LAW.

Due to the low probability of a triple ADR failure, the associated procedure will not be displayed on the ECAM. In this case, the crew will refer to QRH procedure for ADR 1 + 2 + 3 failure.

There is no procedure for IRS 1 + 2 + 3 failure but the ECAM status page will give approach procedure and inoperative systems. In this unlikely event, the standby instruments are the only attitude, altitude, speed and heading references.

*Note: To switch OFF an ADR, the flight crew must use the ADR pushbutton. Do not use the rotary selector, because this would also cut off the electrical supply to the IR part.*

### UNRELIABLE AIRSPEED INDICATIONS

R MSN 0002-0860

### PREFACE

Most failures modes of the airspeed/altitude system are detected by the ADIRS. These failures modes lead to the loss of corresponding cockpit indications and the triggering of associated ECAM drills.

However, there may be some cases where the airspeed or altitude output is erroneous without being recognized as such by the ADIRS. In these cases, the cockpit indications appear normal but are actually false and pilots must rely on their basic flying skills to identify the faulty source and take the required corrective actions. When only one source provides erroneous data, a straightforward crosscheck of the parameters provided by the three ADRs allows the faulty ADR

	<b>ABNORMAL OPERATIONS</b>	03.034
	NAVIGATION	JAN 09/07

to be identified. This identification becomes more difficult in extreme situation when two, or even all of three, sources provide erroneous information.

### **MAIN REASONS FOR ERRONEOUS AIRSPEED/ALTITUDE DATA**

The most probable reason for erroneous airspeed and altitude information is obstructed pitot tubes or static sources. Depending on the level of obstruction, the symptoms visible to the flight crew will be different. However, in all cases, the data provided by the obstructed probe will be false. Since it is highly unlikely that the aircraft probes will be obstructed at the same time, to the same degree and in the same way, the first indication of erroneous airspeed/altitude data available to flight crews, will most probably be a discrepancy between the various sources.

### **CONSEQUENCES OF OBSTRUCTED PITOT TUBES OR STATIC PORTS**

All aircraft systems, using anemometric data, have been built-in fault accommodation logics. The fault accommodation logics are not the same for various systems but, all rely on voting principle whereby when one source diverges from the average value, it is automatically rejected and the system continues to operate normally with the remaining two sources. This principle applies to flight controls and flight guidance systems.

### **NORMAL SITUATION**

Each PRIM receives speed information from all ADIRUs and compares the 3 values. Pressure altitude information is not used by the PRIM. Each FE (Flight Envelope computer) receives speed and pressure information from all ADIRUs and compares the 3 values.

### **ONE ADR OUTPUT IS ERRONEOUS AND THE TWO REMAINING ARE CORRECT**

The PRIMs and the FEs eliminate it.

On basic A330 and A340-200/300, there is no cockpit effect (no caution, normal operation is continued), except that one display is wrong and CAT3 DUAL is displayed as INOP SYS on STATUS page.

On the A340-500/600 and enhanced 330 and 340-300, if one ADR deviates, and if this ADR is used to display the speed information on either the CAPT or F/O PFD, a NAV IAS DISCREPANCY caution is triggered. Furthermore, as with the A340-200/300, CAT3 DUAL is displayed as INOP SYS on STATUS page.

### **TWO ADR OUTPUTS ARE ERRONEOUS, BUT DIFFERENT, AND THE REMAINING ADR IS CORRECT, OR IF ALL THREE ARE ERRONEOUS, BUT DIFFERENT :**

	<b>ABNORMAL OPERATIONS</b>	03.034
	NAVIGATION	JAN 09/07

The autopilot and the auto thrust are disconnected by the FE (whichever autopilot is engaged). If the disagree lasts for more than 10 seconds, the PRIM triggers the NAV ADR DISAGREE ECAM caution.

Flight controls revert to Alternate 2 law (without high and low speed protection).  
On both PFDs : The "SPD LIM" flag is shown ; no VLS and no VSW is displayed. This situation is latched, until a PRIM reset is performed on ground, without any hydraulic pressure.

However, if the anomaly was only transient, the autopilot and the autothrust can be re-engaged when the disagree has disappeared.

**ONE ADR IS CORRECT, BUT THE OTHER TWO ADRS PROVIDE THE SAME ERRONEOUS OUTPUT, OR IF ALL THREE ADRS PROVIDE CONSISTENT AND ERRONEOUS DATA :**

The systems will reject the "good" ADR and will continue to operate normally using the two "bad" ADRs. This condition can be met when, for example, two or all three pitot tubes are obstructed at the same time, to the same degree, and in the same way. (Flight through a cloud of volcanic ash, takeoff with two pitots obstructed by foreign matter (mud, insects)).

The following chart provides a non-exhaustive list of the consequences of various cases of partially or totally obstructed pitot tubes and static ports on airspeed and altitude indications. It should be noted that the cases described below cover extreme situations (e.g. totally obstructed or unobstructed drain holes), and that there could be multiple intermediate configurations with similar, but not identical, consequences.

FAILURE CASE	CONSEQUENCES
Water accumulated due to heavy rain.Drain holes unobstructed.	Transient speed drop until water drains.IAS fluctuations.IAS step drop and gradual return to normal.
Water accumulated due to heavy rain.Drain holes obstructed.	Permanent speed drop.
Ice accretion due to pitot heat failure, ortransient pitot blocked due to severe icing.Unobstructed drain holes.	Total pressure leaks towards static pressure.IAS drop until obstruction cleared/fluctuation, if transient erratic A/THR istransient.



	<b>ABNORMAL OPERATIONS</b>	03.034
	NAVIGATION	JAN 09/07

Ice accretion due to pitot heat failure, or pitot obstruction due to foreign objects. Obstructed drain holes.	Total pressure blocked. Constant IAS in level flight, until obstruction is cleared. In climb, IAS increases. In descent, IAS decreases. Abnormal AP/FD/ATHR behavior : a) AP/FD pitch up in OPN CLB to hold target IAS. b) AP/FD pitch down in OPN DES to hold target IAS
Total obstruction of static ports on ground.	Static pressure blocked at airfield level. Normal indications during T/O roll. After lift-off altitude remains constant. IAS decreases, after lift-off. IAS decreases, when aircraft climbs. IAS increases, when aircraft descends.

The above table clearly illustrates that no single rule can be given to conclusively identify all possible erroneous airspeed/altitude indications cases.

**ADR CHECK PROC / UNRELIABLE SPEED INDICATION QRH PROCEDURE**

R MSN 0002-0860

R (2)

**INTRODUCTION**

The ADR CHECK PROC / UNRELIABLE SPEED INDICATIONS procedure has two objectives: to identify and isolate the faulty ADR (s), and, if not successful, to fly the aircraft until landing without any speed reference.

It includes the following steps:

1. Memory items
2. Trouble shooting and isolation
3. Flight using Pitch/thrust references.

**WHEN TO APPLY THIS PROCEDURE?**

	<b>ABNORMAL OPERATIONS</b>	03.034
	NAVIGATION	JAN 09/07

The flight crew may enter this procedure, either upon ECAM request (ADR DISAGREE or ANTI-ICE PITOT caution), or because he suspects an erroneous indication, without any ECAM warning.

Erroneous speed/altitude indication can be suspected by:

1. Speed discrepancy (between ADR1, 2, 3, and standby indication)
2. Fluctuating or unexpected increase/decrease/permanent indicated speed, or pressure altitude.
3. Abnormal correlation of basic flight parameters (IAS, pitch, attitude, thrust, climb rate) :
  - . IAS increasing, with large nose-up pitch attitude
  - . IAS decreasing, with large nose down pitch attitude
  - . IAS decreasing, with nose down pitch attitude and aircraft descending
4. Abnormal AP/FD/ATHR behavior
5. STALL warning, or OVERSPEED warnings, or a Flap RELIEF ECAM message, that contradicts with at least one of the indicated speeds.
  - . Rely on the stall warning that could be triggered in alternate or direct law. It is not affected by unreliable speeds, because it is based on angle of attack.
  - . Depending on the failure, the OVERSPEED warning may be false or justified. Buffet, associated with the OVERSPEED VFE warning, is a symptom of a real overspeed condition.
6. Inconsistency between radio altitude and pressure altitude.
7. Reduction in aerodynamic noise with increasing speed, or increase in aerodynamic noise with decreasing speed.
8. Impossibility of extending the landing gear by the normal landing gear system.

#### **HOW TO APPLY THIS PROCEDURE?**

R (3)

R (4)



	<b>ABNORMAL OPERATIONS</b>	03.034
	NAVIGATION	JAN 09/07

Once the target pitch attitude and thrust values have been stabilized, as soon as above safe altitude, the flight crew will enter the 2nd part of the QRH procedure, to level off the aircraft and perform trouble shooting. This should not be delayed, since using the memory item parameters for a prolonged period may lead to speed limit exceedance.

## **PART 2: TROUBLE SHOOTING AND ISOLATION**

### **GENERAL**

If the wrong speed or altitude information does not affect the safe conduct of the flight, the crew will not apply the memory items, and will directly enter the part 2 of the QRH procedure.

Depending of the cause of the failure, the altitude indication may also be unreliable. There are however, a number of correct indications available to the crew. GPS altitude and ground speed are available on MCDU GPS monitor page and RA may be used at low level.

For faulty ADR (s) identification, the flight crew may, either level off and stabilize the flight using the dedicated table in PART 2, or, if for instance already stabilized in climb, use the CLIMB table given in part 3. The trouble shooting will be more accurate, using the level off table.

### **LEVEL OFF AND STABILIZATION (IF REQUIRED)**

The table gives the proper pitch and thrust values for stabilization in level off according to weight, configuration and altitude.

It must be noticed that, if the altitude information is unreliable, FPV and V/S are also affected. In this case, the GPS altitude, if available, is the only means to confirm when the aircraft is maintaining a level. When reliable, the FPV should be used.

If the memory items have been maintained for a significant period of time, the current speed may be quite above the target

#### **If FPV is reliable, or if GPS altitude information is available:**

- Maintain level flight (FPV on the horizon or constant GPS altitude)
- Adjust thrust according to the table
- Observe the resulting pitch attitude, and compare it with the recommended table pitch target.
  - . If the aircraft pitch to maintain level flight is above the table pitch target, the aircraft is slow, then increase thrust

	<b>ABNORMAL OPERATIONS</b>	03.034
	NAVIGATION	JAN 09/07

- . If the aircraft pitch to maintain level flight is below the table pitch target, the aircraft is fast, then decrease thrust

When the pitch required to maintain level off gets close to the table pitch target, re-adjust thrust according to table thrust target.

This technique permits to stabilize the speed quickly, without inducing altitude changes.

If FPV is not reliable and GPS altitude information is not available (no means to ensure level flight):

Adjust pitch and thrust according to table, and wait for speed stabilization. Expect a significant stabilization time and important altitude variations.

## **TROUBLE SHOOTING AND FAULT ISOLATION**

When one indication differs from the others, flight crews may be tempted to reject the outlier information. They should be aware, however, that in very extreme circumstances, it may happen that two, or even all three ADRs may provide identical and erroneous data.

### **BEWARE OF INSTINCTIVELY REJECTING AN OUTLIER ADR**

Once the faulty ADR has (or have) been positively identified, it (they) should be switched OFF. This will trigger the corresponding ECAM warnings and associated drills, which should be followed to address all the consequences on the various aircraft systems.

In the extreme case where the faulty ADR(s) cannot be identified and all speed indications remain unreliable, 2 ADRs should be selected OFF to prevent the flight control laws from using two coherent but unreliable ADR data. One must be kept ON to keep the stall warning protection.

If at least one ADR remains reliable, the flight crew will use it (after having confirmed its validity), and so, will stop the application of the ADR CHECK PROC / UNRELIABLE SPEED INDICATION PROC.

## **PART 3: FLYING WITHOUT ANY SPEED REFERENCE**

When the trouble shooting procedure did not permit to identify at least one correct indication, this part of the procedure gives pitch/thrust reference to fly the aircraft safely, in all flight phases, down to landing.

The flight crew may enter directly this part if he knows already that no speed information is reliable (for instance in case of dual pitot heating failure, plus an ADR failure), or if level off for trouble shooting is not convenient from an operational point of view, for instance in descent, close to destination.

	<b>ABNORMAL OPERATIONS</b>	03.034
	NAVIGATION	JAN 09/07

When flying the aircraft with unreliable speed and/or altitude indications, it is recommended to change only one flying parameter at a time i.e. speed, altitude or configuration. For this reason, a wide pattern and a stabilized approach are recommended.

For final approach, if available, an ILS (with a  $-3^\circ$  G/S) will ensure path guidance.

If final descent is started with stabilized speed (VAPP), flying a  $-3^\circ$  flight path with the recommended table thrust, the resulting pitch attitude should be close to the recommended table pitch value. If an adjustment is required, vary the thrust, as explain in the initial level off paragraph.

R MSN 0002-0860

R (5)

### DUAL RADIO ALTIMETER FAILURE

The Radio Altimeters (RAs) provide inputs to a number of systems, including the GPWS and FWC for auto-callouts. They also supply information to the AP and A/THR modes, plus inputs to switch flight control laws at various stages. Although the ECAM procedure for a RA 1 + 2 FAULT is straightforward, the consequences of the failure on the aircraft operation require consideration.

Instead of using RA information, the flight control system uses inputs from the LGCIU to determine mode switching. Consequently, mode switching is as follows:

- . At take-off, normal law becomes active when the MLG is no longer compressed and pitch attitude becomes greater than  $8^\circ$
- . On approach, flare law becomes active when the L/G is selected down and provided AP is disconnected. At this point, "USE MAN PITCH TRIM" is displayed on the PFD.

*Note: The L/G DOWN NOT DOWN alert appears in approach when CONF2 is selected*

- . After landing, ground law becomes active when the MLG is compressed and the pitch attitude becomes less than  $2.5^\circ$

It is not possible to capture the ILS using the APPR pb and the approach must be flown to CAT 1 limits only. However, it is possible to capture the localiser using the LOC pb.

Furthermore, the final stages of the approach should be flown using raw data in order to avoid possible excessive roll rates if LOC is still engaged. Indeed, as

	<b>ABNORMAL OPERATIONS</b>	03.034
	NAVIGATION	JAN 09/07

the autopilot gains are no longer updated with the radio altitude signal, the AP/FD behaviour may be unsatisfactory when approaching the ground.

There will be no auto-callouts on approach, and no "RETARD" call in the flare

The GPWS/EGPWS will be inoperative; therefore terrain awareness becomes very important. Similarly, the "SPEED, SPEED, SPEED" low energy warning is also inoperative, again requiring increased awareness.

	<b>ABNORMAL OPERATIONS</b>  NAVIGATION	03.034
		JAN 09/07

**HIGHLIGHTS**

- (1) A note is added to avoid an error frequently reported in training.
- (2) Correction of printing error
- (3) Deleted item "
- (4) New item " for 'MSN 0002-0860'
- (5) Addition of a note concerning an alert in approach.



**ALL ENGINE FLAMEOUT**

- R MSN 0002-0860
- R (1)
- R (2)

Following an all engine flame out, the flight deck indications change dramatically as the generators drop off line. The RAT is deployed to supply the emergency generator and pressurize the green hydraulic circuit.

Control of the aircraft must be taken immediately by the left hand seat pilot, and a safe flight path established.

When convenient, an emergency will be declared to ATC using VHF1. Depending on the exact situation, assistance may be available from ATC regarding position of other aircraft, safe direction etc.

Significant remaining systems in ALL ENGINES FLAME OUT	
FLY	PFD1, Alternate law
NAVIGATE	RMP1, VOR1
COMMUNICATE	VHF1

*Note: The AP, pitch trim and rudder trim are not available.*

If engine wind milling is sufficient

- . Additional hydraulic power may be recovered
- . The EDP may supply the emergency generator, which improves the electrical configuration.

The ECAM actions are displayed and allow coping with this situation. However, as the ECAM cannot distinguish whether fuel is available or not, they provide a dimensioning procedure which cover all cases. Furthermore, The ECAM procedure refers to paper QRH for OPERATING SPEEDS, L/G GRAVITY EXTENSION and DITCHING or FORCED LANDING.

It is the reason why the ENG ALL ENG FLAME OUT FUEL REMAINING or ENG ALL ENG FLAME OUT NO FUEL REMAINING are available in the QRH. As they distinguish whether fuel is available or not, these single paper procedures are optimized for each case and include the required paper procedure e.g. L/G GRAVITY EXTENSION. Consequently, the crew should apply the QRH procedure and then, if time permits, clear ECAM warning to read status.

In the fuel remaining case,

	<b>ABNORMAL OPERATIONS</b>	03.070
	<b>POWER PLANT</b>	JAN 09/07

- . The actions should be commenced, with attention to the optimum relight speed without starter assist (with wind milling). If there is no relight within 30 seconds, the ECAM will order engine masters off for 30 seconds. This is to permit ventilation of the combustion chamber. Then, the engine masters may be set ON again. Without starter assist (wind milling), this can be done at the same time.
- . If the crew wants to take credit of the APU bleed air, the APU should be started below FL 250. Below FL 200, an engine relight should be attempted with starter assist (using the APU bleed).
- . As green dot is not displayed on the left PFD, the PF will initially use the initial speed with starter assist before checking green dot in the QRH. With starter assist (APU bleed), only one engine must be started at a time.

When ALL ENGINE FLAMEOUT occurs, as a consequence of the resulting ELEC EMER CONFIG, the LAND RECOVERY AC and DC BUS bars are initially shed and will remain shed until the LAND REC pb is selected ON. This remains true if normal configuration is restored. This is the reason why the crew will also select LAND REC pb ON for approach following a restoration from an ALL ENGINE FLAMEOUT.

R (3)

ALL ENGINE FLAME OUT PROCEDURE



**ENG: ALL ENG FLAME OUT-FUEL REMAINING**

LAND ASAP

**Engine relight attempts**

- OPTIMUM SPEED.....GREEN DOT

Secure cockpit and cabin

**APPROACH PREPARATION**

**APPROACH**

IF FORCED LANDING PREDICATED

**Forced landing procedure**

IF DITCHING predicted

**Ditching procedure**

**ENG: ALL ENG FLAME OUT NO FUEL REMAINING**

LAND ASAP

- OPTIMUM SPEED.....GREEN DOT

Secure cockpit and cabin

**APPROACH PREPARATION**

**APPROACH**

IF FORCED LANDING PREDICATED

**Forced landing procedure**

IF DITCHING predicted

**Ditching procedure**

FOF 03070 04293 0001

	<b>ABNORMAL OPERATIONS</b>	03.070
	POWER PLANT	JAN 09/07

**HIGHLIGHTS**

- (1) Correction of the second version of the procedure, to be used in case of NO FUEL REMAINING
- (2) Deleted item 'All engine flame out procedure'
- (3) New item 'All engine flame out procedure' for 'MSN 0002-0860'

	<b>ABNORMAL OPERATIONS</b>	03.090
	MISCELLANEOUS	JAN 09/07

<b>EMERGENCY DESCENT</b>
--------------------------

R MSN 0002-0860

R (1)

The emergency descent should only be initiated upon positive confirmation that cabin altitude and rate of climb is excessive and uncontrollable. This procedure should be carried out by the crew from memory. The use of AP and autothrust is strongly recommended for an emergency descent. The FCU selections for an emergency descent progress from right to left, i.e. ALT, HDG, SPD.

At high flight levels, the speed brake should be extended slowly while monitoring VLS to avoid the activation of angle of attack protection. This would cause the speedbrakes to retract and may also result in AP disconnection. If structural damage is suspected, caution must be used when using speedbrakes to avoid further airframe stress. When the aircraft is established in the descent, the PF should request the ECAM actions if any or QRH.

The passenger oxygen MASK MAN ON pb should be pressed only when it is clear that cabin altitude will exceed 14,000 ft.

When in idle thrust, high speed and speed brake extended, the rate of descent is approximately 6000 ft/mn. To descend from FL410 to FL100, it takes approximately 5 mn and 40 NM. The crew will be aware that MORA displayed on ND is the highest MORA value within a circle of 40 NM radius around the aircraft.

EMERGENCY DESCENT FLOW PATTERN

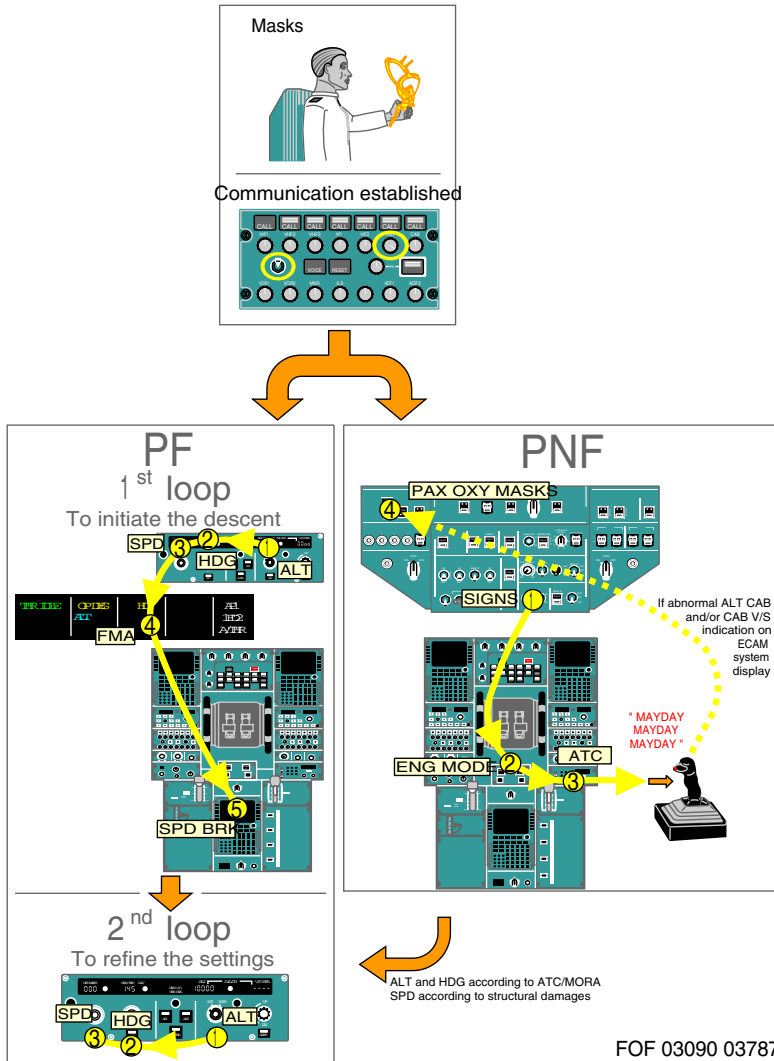

After taking off the emergency mask following an emergency descent, the crew should close the mask box and reset the control slide in order to activate the regular microphone again.

**OVERWEIGHT LANDING**

	<b>ABNORMAL OPERATIONS</b>  MISCELLANEOUS	03.090
		JAN 09/07

R MSN 0012 0017 0030 0037 0045 0050 0054-0055 0059-0060 0062 0064-0073 0077  
 0082-0083 0086-0087 0095-0096 0098-0100 0102 0106-0113 0116 0118-0122 0127 0132 0138  
 0140 0143-0144 0148 0153 0155 0162 0165 0171-0172 0177 0181 0183-0184 0188-0189  
 0191 0195 0198 0200 0203 0205-0206 0209 0211 0219 0222-0224 0226 0229-0232 0234  
 0238 0240-0241 0244 0247-0251 0253-0256 0258-0259 0261-0262 0265-0267 0269 0271-0272  
 0275-0277 0279 0281 0283-0291 0293-0296 0299-0301 0303 0305-0306 0308-0309 0311-0317  
 0320 0322-0324 0326 0328 0330 0333-0334 0337-0346 0348-0351 0353 0356-0358 0361-0362  
 0364-0366 0368-0370 0372 0375 0380 0382 0384 0386 0388-0389 0392-0393 0396-0398  
 0400-0401 0403-0405 0407-0409 0412 0418-0423 0425 0427-0428 0432 0437 0439 0441  
 0443-0444 0448 0451-0452 0454-0456 0458 0461-0463 0465-0466 0469 0472-0473 0476-0477  
 0479-0481 0484 0486-0487 0489-0491 0493-0494 0496-0498 0500-0513 0515-0516 0518-0519  
 0521-0522 0524-0527 0529-0530 0532-0533 0535-0536 0539 0542 0548-0553 0555 0558  
 0564-0565 0567-0568 0570-0571 0573-0574 0576 0578-0579 0581 0584 0587-0588 0591-0597  
 0600 0602-0603 0605 0607 0609-0610 0612-0614 0616 0618 0620-0621 0623 0625 0627  
 0629 0631-0638 0640-0642 0644-0645 0647-0650 0652-0667 0669-0671 0673-0676 0678-0680  
 0682-0684 0686-0688 0690-0693 0695-0697 0699-0701 0703-0705 0707-0709 0711-0714  
 0716-0718 0720-0722 0724-0726 0728-0730 0732-0735 0737-0739 0741-0743 0745-0747  
 0749-0752 0754-0756 0758-0760 0769-0770 0772-0774 0776-0778 0780-0782 0784-0786  
 0788-0789 0791-0792 0795-0797 0799 0801-0803 0805-0811 0813-0828 0830-0834 0836  
 0838-0843 0845 0847 0849-0860

Overweight landing can be performed "in exceptional conditions" (in flight turn back or diversion), provided the crew follows the OVERWEIGHT LANDING procedure. The decision to jettison remains at captain discretion after the analysis of various parameters such as runway length, aircraft conditions, emergency situation...

Should an overweight landing be required, a long straight in approach, or a wide visual pattern, should be flown in order to configure the aircraft for a stabilized approach.

At high weight, the green dot speed for the current configuration may be close to, or even above the VFE CONF1. In this case, the procedure is to select the speed to VFE next 5kts (but not below VLS) and then select the next configuration as the speed decreases through VFE next. As the slats extend, VLS will reduce. Once completed, speed should then be managed.

While approaching S speed and when selecting flaps 2, the Flap Load Relief System (FLRS) may be activated and RELIEF is displayed on the EWD Flap/Slat indication. The flap 2 extension is slightly delayed until the speed gets below the corresponding VFE CONF2.

The stabilized approach technique should be used, and VAPP established at the FAF. The speed will be reduced to VLS in the final stages of the approach to minimize the aircraft energy.

The crew will elect the landing configuration according to "Maximum weight for go-around in CONF3" table provided in QRH. CONF FULL is preferred for optimized landing performance. However, if the aircraft weight is above the maximum weight for go-around, the crew will use CONF3 for landing and 1+F for go-around. The approach climb gradient limiting weight CONF 1+F is never limiting.

If a go-around CONF 1+F is carried out, VLS CONF 1+F may be higher than VLS CONF3+5 kt. The recommendation in such a case is to follow SRS orders which will accelerate the aircraft up to the displayed VLS. It should be noted, however, that VLS CONF 1+F equates to 1.23 VS1G whereas the minimum go-around speed required by regulations is 1.13 VS1G. This requirement is always satisfied.

The approach climb gradient limiting weight tables in QRH are provided for conservative QNH and consequently may slightly differ from FCOM 3.05.35.

The crew should be aware that the transition from -3 ° flight path angle to go around climb gradient requires a lot of energy and therefore some altitude loss.

The maximum brake energy and maximum tire speed limiting weights are not limiting even in an overweight landing configuration.

Taking into account the runway landing distance available, the use of brakes should be modulated to avoid very hot brakes and the risk of tire deflation.

When the aircraft weight exceeds the maximum landing weight, structural considerations impose the ability to touch down at 360 ft/mn without damage. This means that no maintenance inspection is required if vertical speed is below 360 ft/mn. If vertical speed exceeds 360 ft/mn at touch down, a maintenance inspection is required.

R MSN 0002-0011 0013-0016 0018-0029 0031-0035 0038-0044 0046-0049 0051-0053 0056-0058  
 0061 0063 0074-0076 0078-0081 0084-0085 0088-0094 0097 0101 0103-0104 0114-0115 0117  
 0123-0126 0128-0131 0133-0137 0139 0141-0142 0145-0147 0149-0152 0154 0156-0161  
 0163-0164 0166-0170 0173-0176 0178-0180 0182 0185-0187 0190 0192-0194 0196-0197 0199  
 0201-0202 0204 0207-0208 0210 0212-0218 0220-0221 0225 0227-0228 0233 0235-0237  
 0239 0242-0243 0245-0246 0252 0257 0260 0263-0264 0268 0270 0273-0274 0278 0280  
 0282 0292 0297 0302 0304 0307 0310 0318-0319 0321 0325 0327 0329 0331-0332 0335  
 0347 0352 0354-0355 0359 0363 0367 0373-0374 0377-0379 0381 0385 0387 0390 0395  
 0399 0402 0406 0411 0413-0415 0424 0429-0430 0433-0435 0438 0442 0446-0447 0450  
 0459 0467 0470 0474 0483 0528 0538 0541 0544-0546 0554 0556 0559 0561-0562 0582  
 0585 0590 0598 0643 0646 0651 0668 0793 0800 0835 0844

Overweight landing can be performed "in exceptional conditions" (in flight turn back or diversion), provided the crew follows the OVERWEIGHT LANDING procedure. The decision to jettison remains at captain discretion after the analysis of various parameters such as runway length, aircraft conditions, emergency situation...



	<b>ABNORMAL OPERATIONS</b>	03.090
	MISCELLANEOUS	JAN 09/07

Automatic landing is certified up to MLW, but flight tests have been performed successfully up to MTOW. In case of emergency, and under crew responsibility, an automatic landing may be performed up to MTOW provided that the runway is approved for automatic landing.

Should an overweight landing be required, a long straight in approach, or a wide visual pattern, should be flown in order to configure the aircraft for a stabilized approach.

At high weight, the green dot speed for the current configuration may be close to, or even above the VFE CONF1. In this case, the procedure is to select the speed to VFE next 5kts (but not below VLS) and then select the next configuration as the speed decreases through VFE next. As the slats extend, VLS will reduce. Once completed, speed should then be managed.

While approaching S speed and when selecting flaps 2, the Flap Load Relief System (FLRS) may be activated and RELIEF is displayed on the EWD Flap/Slat indication. The flap 2 extension is slightly delayed until the speed gets below the corresponding VFE CONF2.

The stabilized approach technique should be used, and VAPP established at the FAF. The speed will be reduced to VLS in the final stages of the approach to minimize the aircraft energy.

The crew will elect the landing configuration according to "Maximum weight for go-around in CONF3" table provided in QRH. CONF FULL is preferred for optimized landing performance. However, if the aircraft weight is above the maximum weight for go-around, the crew will use CONF3 for landing and 1+F for go-around. The approach climb gradient limiting weight CONF 1+F is never limiting.

If a go-around CONF 1+F is carried out, VLS CONF 1+F may be higher than VLS CONF3+5 kt. The recommendation in such a case is to follow SRS orders which will accelerate the aircraft up to the displayed VLS. It should be noted, however, that VLS CONF 1+F equates to 1.23 VS1G whereas the minimum go-around speed required by regulations is 1.13 VS1G. This requirement is always satisfied.

The approach climb gradient limiting weight tables in QRH are provided for conservative QNH and consequently may slightly differ from FCOM 3.05.35.

The crew should be aware that the transition from -3° flight path angle to go around climb gradient requires a lot of energy and therefore some altitude loss.

Generally speaking, the maximum brake energy and maximum tire speed limiting weights are not limiting even in an overweight landing configuration.

Taking into account the runway landing distance available, the use of brakes should be modulated to avoid very hot brakes and the risk of tire deflation.

	<b>ABNORMAL OPERATIONS</b>	03.090
	MISCELLANEOUS	JAN 09/07

When the aircraft weight exceeds the maximum landing weight, structural considerations impose the ability to touch down at 360 ft/mn without damage. This means that no maintenance inspection is required if vertical speed is below 360 ft/mn. If vertical speed exceeds 360 ft/mn at touch down, a maintenance inspection is required.

R MSN 0371 0376 0383 0391 0410 0416-0417 0426 0431 0436 0440 0449 0453 0460 0468 0475 0482 0488 0514 0517 0523 0531 0534 0537 0540 0543 0547 0557 0566 0569 0575 0577 0580 0583 0586 0601 0604 0606 0615 0617 0619 0622 0626 0630 0639 0672 0677 0681 0689 0702 0706 0710 0715 0719 0723 0727 0731 0736 0740 0744 0753 0762-0768 0771 0779 0787 0790 0794 0798 0804 0812 0829 0837 0846 0848

Overweight landing can be performed "in exceptional conditions" (in flight turn back or diversion), provided the crew follows the OVERWEIGHT LANDING procedure. The decision to jettison remains at captain discretion after the analysis of various parameters such as runway length, aircraft conditions, emergency situation...

Automatic landing is certified up to the MLW, but flight tests have been performed successfully up to 270 tons. In case of emergency, and under crew responsibility, an automatic landing may be performed up to 270 tons provided that the runway is approved for automatic landing. Above 270 tons, the AP may be used down to 100 feet AGL.

Should an overweight landing be required, a long straight in approach, or a wide visual pattern, should be flown in order to configure the aircraft for a stabilized approach.

While approaching S speed and when selecting CONF 2, the Flap Load Relief System (FLRS) may be activated and RELIEF is displayed on the EWD Flap/Slat indication. The flap 2 extension is slightly delayed until the speed gets below the corresponding VFE CONF2.

The stabilized approach technique should be used, and VAPP established at the FAF. The speed will be reduced to VLS in the final stages of the approach to minimize the aircraft energy.

The crew will elect the landing configuration according to "limiting weight for landing in conf full and in conf 3" tables provided in QRH. These tables inform the crew, whether or not, tire speed or brake energy limiting weight intervenes. The lowest limiting weight applies.

If a go-around CONF 1+F is carried out following an approach CONF3, VLS CONF 1+F may be higher than VLS CONF3+5 kt. The recommendation in such a case is to follow SRS orders which will accelerate the aircraft up to the displayed VLS. It should be noted, however, that VLS CONF 1+F equates to 1.23 VS1G whereas the minimum go-around speed required by regulations is 1.13 VS1G. This requirement is always satisfied.

	<b>ABNORMAL OPERATIONS</b>	03.090
	MISCELLANEOUS	JAN 09/07

The limiting weight tables in QRH are provided for conservative QNH and consequently may slightly differ from FCOM 3.05.35.

The crew should be aware that the transition from -3° flight path angle to go around climb gradient requires a lot of energy and therefore some altitude loss.

Taking into account the runway landing distance available, the use of brakes should be modulated to avoid very hot brakes and the risk of tire deflation.

When the aircraft weight exceeds the maximum landing weight, structural considerations impose the ability to touch down at 360 ft/mn without damage. This means that no maintenance inspection is required if vertical speed is below 360 ft/mn. If vertical speed exceeds 360 ft/mn at touch down, a maintenance inspection is required.

R MSN 0394 0445 0457 0464 0471 0478 0485 0492 0495 0499 0520 0560 0563 0572 0608  
0611 0624 0628 0685 0694 0698 0748 0757 0761 0775 0783

Overweight landing can be performed "in exceptional conditions" (in flight turn back or diversion), provided the crew follows the OVERWEIGHT LANDING procedure. The decision to jettison remains at captain discretion after the analysis of various parameters such as runway length, aircraft conditions, emergency situation...

Automatic landing is certified up to MLW, but flight tests have been performed successfully up to 250 tons. In case of emergency, and under crew responsibility, an automatic landing may be performed up to 250 tons, provided the runway is approved for automatic landing. Above 250 tons, the AP may be used down to 100 feet AGL.

Should an overweight landing be required, a long straight in approach, or a wide visual pattern, should be flown in order to configure the aircraft for a stabilized approach.

While approaching S speed and when selecting CONF 2, the Flap Load Relief System (FLRS) may be activated and RELIEF is displayed on the EWD Flap/Slat indication. The flap 2 extension is slightly delayed until the speed gets below the corresponding VFE CONF2.

The stabilized approach technique should be used, and VAPP established at the FAF. The speed will be reduced to VLS in the final stages of the approach to minimize the aircraft energy.

The crew will elect the landing configuration according to "limiting weight for landing in conf full and in conf 3" tables provided in QRH. These tables inform the crew, whether or not, tire speed or brake energy limiting weight intervenes. The lowest limiting weight applies.

If a go-around CONF 1+F is carried out following an approach CONF3, VLS CONF 1+F may be higher than VLS CONF3+5 kt. The recommendation in such

	<b>ABNORMAL OPERATIONS</b>	03.090
	MISCELLANEOUS	JAN 09/07

a case is to follow SRS orders which will accelerate the aircraft up to the displayed VLS. It should be noted, however, that VLS CONF 1+F equates to 1.23 VS1G whereas the minimum go-around speed required by regulations is 1.13 VS1G. This requirement is always satisfied.

The limiting weight tables in QRH are provided for conservative QNH and consequently may slightly differ from FCOM 3.05.35.

The crew should be aware that the transition from -3 ° flight path angle to go around climb gradient requires a lot of energy and therefore some altitude loss.

Taking into account the runway landing distance available, the use of brakes should be modulated to avoid very hot brakes and the risk of tire deflation.

When the aircraft weight exceeds the maximum landing weight, structural considerations impose the ability to touch down at 360 ft/mn without damage. This means that no maintenance inspection is required if vertical speed is below 360 ft/mn. If vertical speed exceeds 360 ft/mn at touch down, a maintenance inspection is required.

## CREW INCAPACITATION

R MSN 0002-0860

### GENERAL

Crew incapacitation is a real safety hazard which occurs most frequently than many of the other emergencies. Incapacitation can occur in many form varying from obvious sudden death to subtle, partial loss of function. It may not be preceded by any warning.

### RECOGNITION

The keys to early recognition of the incapacitation are:

- . Routine monitoring and cross checking of flight instruments
- . Crew members should have a very high index of suspicion of a subtle incapacitation
- . If one crew member do not feel well, the other crew must be advised
- . Others symptoms e.g. incoherent speech, pale fixed facial expression or irregular breathing could indicate the beginning of an incapacitation.

	<b>ABNORMAL OPERATIONS</b>	03.090
	MISCELLANEOUS	JAN 09/07

## ACTION

The recovery from a detected incapacitation of the fit pilot shall follow the sequence below:

### First phase

- . Assume control, return the aircraft to a safe flight path, announce "I have control", use the take-over pb and engage the on side AP as required.
- . Declare an emergency to ATC
- . Take whatever steps are possible to ensure the incapacitated pilot cannot interfere with the handling of the aircraft. This may include involving cabin crew to restrain the incapacitated pilot
- . Request assistance from any medically qualified passenger
- . Check if a type qualified company pilot is on board to replace the incapacitated crew member
- . Land as soon as practicable after considering all pertinent factors
- . Arrange medical assistance after landing giving many details about the condition of the affected crewmember

### Second phase

- . Prepare the approach and read the checklist earlier than usual
- . Request radar vectoring and prefer a long approach to reduce workload
- . Perform the landing from the fit pilot usual place

	<b>ABNORMAL OPERATIONS</b>	03.090
	MISCELLANEOUS	JAN 09/07

**HIGHLIGHTS**

- (1) Addition of recommendation to re-activate the microphone

<b>04.010</b>	<b>ADVERSE WEATHER</b>	
	- GENERAL	1
	- COLD WEATHER OPERATIONS AND ICING CONDITIONS	1
	- TURBULENCE	9
	- WINDSHEAR	11
	- VOLCANIC ASH	16
<b>04.020</b>	<b>FLYING REFERENCE</b>	
	- GENERAL	1
	- THE ATTITUDE	1
	- THE FLIGHT PATH VECTOR	1
	- GO AROUND	5
<b>04.030</b>	<b>NAVIGATION ACCURACY</b>	
	- GENERAL	1
	- COMPUTATION OF THE AIRCRAFT POSITION	1
	- USE OF FMS	4
	- AIRCRAFT POSITION AWARENESS AND OPERATIONAL CONSEQUENCES	5
<b>04.040</b>	<b>ZFW - ZFCG ENTRY ERRORS</b>	
	- GENERAL	1
	- TECHNICAL BACKGROUND	1
	- ENTRY ERROR AND OPERATIONAL CONSEQUENCES	3
	- OPERATIONAL RECOMMENDATIONS	4
<b>04.050</b>	<b>CENTRE OF GRAVITY</b>	
	- PREFACE	1
	- MECHANICAL ASSUMPTIONS	1
	- INFLUENCE OF THE CENTER OF GRAVITY ON THE AIRCRAFT PERFORMANCE	2
	- INFLUENCE OF THE CG ON THE STRUCTURE AND HANDLING CHARACTERISTICS	4
	- THE CG AND TRIM POSITION	8
<b>04.060</b>	<b>TCAS</b>	

	<b>SUPPLEMENTARY INFORMATION</b> <b>TABLE OF CONTENTS</b>	04.000
		JAN 09/07

	- TECHNICAL BACKGROUND	1
	- OPERATIONAL RECOMMENDATION	2
<b>04.070</b>	<b>USE OF RADAR</b>	
	- GENERAL	1
	- FUNCTIONS	1
	- OPERATIONAL RECOMMENDATIONS FOR WEATHER DETECTION	5
	- OTHER OPERATIONNAL RECOMMENDATION	8



**GENERAL**

R MSN 0002-0860

Adverse weather operations take into account the following aspects:

- . Cold weather operations and icing conditions
- . Turbulence
- . Windshear
- . Volcanic ash.

**COLD WEATHER OPERATIONS AND ICING CONDITIONS**

R MSN 0002-0860

R (1)

**PREFACE**

Aircraft performance is certified on the basis of a clean wing. Ice accretion affects wing performance. When the wing is clean, the airflow smoothly follows the shape of the wing. When the wing is covered with ice, the airflow separates from the wing when the Angle-Of-Attack (AOA) increases. Therefore, the maximum lift-coefficient is reduced. As a result, the aircraft may stall at a lower AOA, and the drag may increase.

The flight crew must keep in mind that the wing temperature of the aircraft may be significantly lower than 0 deg. C, after a flight at high altitude and low temperature, even if the Outside Air Temperature (OAT) is higher than 0 deg. C. In such cases, humidity or rain will cause ice accretion on the upper wing, and light frost under the wing. (Only 3 mm of frost on the under-surface of the wing is acceptable.)

**EXTERIOR INSPECTION**

When ground-icing conditions are encountered, and/or when ice accretion is suspected, the Captain should determine, on the basis of the exterior inspection, whether the aircraft requires ground deicing/anti-icing treatment. This visual inspection must take into account all vital parts of the aircraft, and must be performed from locations that offer a clear view of these parts.

	<b>SUPPLEMENTARY INFORMATION</b>	04.010
	<b>ADVERSE WEATHER</b>	JAN 09/07

## **COCKPIT PREPARATION**

The following systems may be affected in very cold weather:

- . EFIS/ECAM (when the cockpit temperature is very low)
- . IRS alignment (may take longer than usual, up to 15 minutes)

The probe and window heating may be used on ground. Heating automatically operates at low power.

## **AIRCRAFT DEICING/ANTI-ICING ON GROUND**

### **DEICING/ANTI-ICING FLUID**

Deicing/anti-icing fluids must be able to remove ice and to prevent its accumulation on aircraft surfaces until the beginning of the takeoff. In addition, the fluids must flow off the surfaces of the aircraft during takeoff, in order not to degrade takeoff performance.

Several types of fluids can be used. These fluids have different characteristics:

<b>type 1</b>	<b>type 2, 3, 4</b>
Low viscosity	High viscosity
Limited holdover time	Longer holdover time
Used mainly for deicing	Used for deicing and anti-icing

The holdover time starts from the beginning of the application of the fluid, and depends on the type of fluid, and on the nature and severity of precipitation. The flight crew should refer to applicable tables as guidelines. These tables must be used in conjunction with the pre-takeoff check.

Depending upon the severity of the weather, the deicing/anti-icing procedure must be applied either:

- . In one step, via the single application of heated and diluted deicing/anti-icing fluid: This procedure provides a short holdover time, and should be used in low moisture conditions only. The holdover time starts from the beginning of the application of the fluid.
- . In two steps, by first applying the heated deicing fluid, then by applying a protective anti-icing fluid: These two sprays must be applied consecutively. The holdover time starts from the beginning of the application of the second fluid.

## **PROCEDURES**

	<b>SUPPLEMENTARY INFORMATION</b>	04.010
	<b>ADVERSE WEATHER</b>	JAN 09/07

The following outlines the various procedures to be applied before and after spraying:

- . All ENG and APU BLEED pushbutton must be set to OFF and the DITCHING pushbutton must be set to ON, to prevent any engine ingestion of deicing/anti-icing fluid.
- . The aircraft can be deiced/anti-iced, with the engine and/or the APU running or off. However, the APU or the engine should not be started during spraying.
- . The aircraft must be deiced/anti-iced symmetrically on both sides.
- . After spraying, keep bleeds off for a few minutes, and perform a visual inspection of the aircraft surfaces.
- . A deicing/anti-icing report must be filled out to indicate the type of fluid and when the spraying began.

#### **AFTER START**

- . Keep the engine bleeds off, with the engines running at higher N1.
- . Keep the APU running with the bleed off for a few minutes after spraying.
- . The slats/flaps and flight controls can be moved, because they no longer have ice.

#### **TAXI-OUT**

On contaminated runways, the taxiing speed should be limited to 10 knots, and any action that could distract the flight crew during taxiing should be delayed until the aircraft is stopped.

The following factors should be taken into account:

- . At speeds below 10 knots: Anti-skid deactivates.
- . Engine anti-ice will increase ground idle thrust.
- . To minimize the risk of skidding during turns: Avoid large tiller inputs.
- . On slippery taxiways: It may be more effective to use differential braking and/or thrust, instead of nosewheel steering.
- . On slush-covered, or snow-covered, taxiways: Flap selection should be delayed until reaching the holding point, in order to avoid contaminating the flap/slat actuation mechanism.
- . When reaching the holding point: The "Before Takeoff down to the line" checklist must be performed.

	<b>SUPPLEMENTARY INFORMATION</b>	04.010
	<b>ADVERSE WEATHER</b>	JAN 09/07

- . The flight crew must maintain the aircraft at an appropriate distance from the aircraft in front.
- . In icing conditions: When holding on ground for extended periods of time, or if engine vibration occurs, thrust should be increased periodically, and immediately before takeoff, to shed any ice from the fan blades.

For more details about this procedure, refer to the FCOM 3.03. 09.

## **TAKEOFF**

### **TAKEOFF PERFORMANCE**

When taking off from contaminated runways, it is not permitted to use FLEX thrust. However, derated thrust may be used, as required, in order to optimize aircraft performance. When available, a derated takeoff thrust results in lower minimum control speeds and, therefore, in a lower V1. A reduction in the minimum control speeds can sometimes enhance takeoff performance.

If anti-ice is used, the flight crew must apply the applicable performance penalty.

Slush, standing water, and/or deep snow reduce the effectiveness of aircraft takeoff performance, because of increased rolling resistance and reduction in tire-to-ground friction. A higher flap setting increases the runway-limited takeoff weight, but reduces the second segment limited takeoff weight.

### **TAKEOFF ROLL**

Before the aircraft lines up on the runway for takeoff, the flight crew must ensure that the airframe has no ice or snow.

Then, before applying thrust, the Captain should ensure that the nosewheel is straight. If there is a tendency to deviate from the runway centerline, this tendency must be neutralized immediately, via rudder pedal steering, not via the tiller.

On contaminated runways, the flight crew should ensure that engine thrust advances symmetrically to help minimize potential problems with directional control.

### **MAXIMUM CROSSWIND**

The following table provides the maximum crosswind that corresponds to the reported runway-friction coefficient:

Reported Braking Action	Reported Runway-Friction Coefficient	Equivalent Runway Condition	Maximum Crosswind (knots)

	<b>SUPPLEMENTARY INFORMATION</b>  <b>ADVERSE WEATHER</b>	04.010
		JAN 09/07

Good/Medium	0.39 to 0.36	1	27
Medium	0.35 to 0.3	2/3	20
Medium/Poor	0.29 to 0.26	2/3	20
Poor	≤0.25	3/4	15
Unreliable	-	4/5	5 (*)

(\*) The maximum crosswind for A330 is not defined, if the reported braking action is not reliable.

The runway condition numbers, in the above table, correspond to the runway conditions:

1. Dry, damp, or wet runway (less than 3 mm depth of water)
2. Runway covered with slush
3. Runway covered with dry snow
4. Runway covered with standing water (with the risk of aquaplaning), or with wet snow
5. Icy runway, or high risk of aquaplaning.

R (2)

**CLIMB/ DESCENT**

Whenever icing conditions are encountered or expected, the engine anti-ice should be turned on. Although the TAT before entering clouds may not require engine anti-ice, flight crews should be aware that the TAT often decreases significantly, when entering clouds.

In climb or cruise, when the SAT decreases to lower than -40 deg. C, engine anti-ice should be turned off, unless flying near CBs.

If the recommended anti-ice procedures are not performed, engine stall, over-temperature, or engine damage may occur.

If it is necessary to turn on the engine anti-ice, and if ice accretion is visible because engine anti-ice was turned on late, then apply the following procedure:

- . Set the ENGINE START selector to IGN
- . Retard one engine, and set the ENG ANTI-ICE pushbutton to ON
- . Smoothly adjust thrust, and wait for stabilization
- . Set the ENGINE START selector to NORM
- . Repeat this procedure for the other engines.

	<b>SUPPLEMENTARY INFORMATION</b>  ADVERSE WEATHER	04.010
		JAN 09/07

Wing anti-ice should be turned on, if either severe ice accretion is expected, or if there is any indication of icing on the airframe.

### **HOLDING**

If holding is performed in icing conditions, the flight crew should maintain clean configuration. This is because prolonged flight in icing conditions with the slats extended should be avoided.

### **APPROACH**

If significant ice accretion develops on parts of the wing that have not been deiced, the aircraft speed must be increased (Ref. FCOM 3.04.30).

When the temperature is lower than ISA-10, the target altitudes (provided by the ATC) must be corrected, by adding the values that are indicated in the table below:

Height	Corrections to be Added		
	ISA - 10	ISA - 20	ISA 30
500	20	40	60
1000	40	80	120
2000	80	160	240
3000	140	260	380
4000	180	340	500
5000	220	420	620

These corrections correspond to approximately  $4 \times \Delta\text{ISA} \times \text{Height (ft)}/1000$

### **LANDING**

Obviously, landings should be avoided on very slippery runways. However, if it is not possible to avoid such landings, the following factors (linked to operations on contaminated runways) should be considered:

- . Braking action
- . Directional control.

### **BRAKING ACTION**

The presence of fluid contaminants on the runway has an adverse effect on braking performance, because it reduces the friction between the tires and the surface of the runway. It also creates a layer of fluid between the tires and the

runway surface, and reduces the contact area. The landing distances, indicated in the QRH, provide a good assessment of the real landing distances for specific levels of contamination.

A firm touchdown should be made and MAX reverse should be selected, as soon as the main landing gear is on ground. Using reversers on a runway that is contaminated with dry snow may reduce visibility, particularly at low speeds. In such cases, reverse thrust should be reduced to idle, if necessary.

The use of MED (4 for A340-500/600) autobrake is recommended, when landing on an evenly contaminated runway. It is possible that the DECEL light on the AUTO BRK panel will not come on, as the predetermined deceleration may not be achieved. This does not mean that the autobrake is not working.

In the case of uneven contamination on a wet or contaminated runway, the autobrake may laterally destabilize the aircraft. If this occurs, consider deselecting the autobrake.

TYPICAL LANDING DISTANCE FACTORS VS. RUNWAY CONDITIONS

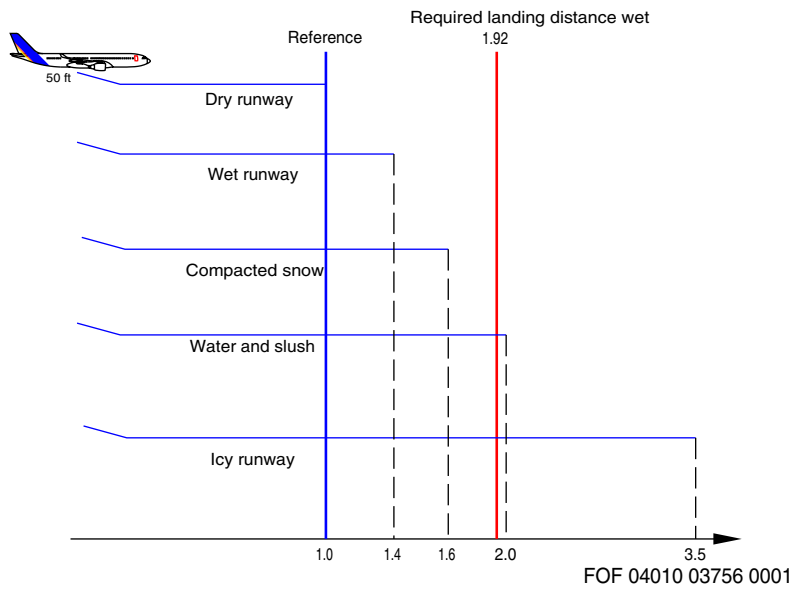

**DIRECTIONAL CONTROL**

During rollout, the sidestick must be centered. This prevents asymmetric wheel loading, that results in asymmetric braking and increases the weathercock tendency of the aircraft.

The rudder should be used for directional control after touchdown, in the same way as for a normal landing. Use of the tiller must be avoided above taxi speed, because it may result in nosewheel skidding, and lead to a loss of directional control.

When required, differential braking must be applied by completely releasing the pedal on the side that is opposite to the expected direction of the turn. This is because, on a slippery runway, the same braking effect may be produced by a full or half-deflection of the pedal.

Landing on a contaminated runway in crosswind requires careful consideration. In such a case, directional control problems are caused by two different factors:

- . If the aircraft touches down with some crab, and reverse thrust is selected, the side-force component of reverse adds to the crosswind component, and causes the aircraft to drift to the downwind side of the runway.
- . As the braking efficiency increases, the cornering force of the main wheels decreases. This adds to any problems there may be with directional control.

If there is a problem with directional control:

- . Reverse thrust should be set to idle, in order to reduce the reverse thrust side-force component.
- . The brakes should be released, in order to increase the cornering force.
- . The pilot should return to the runway centerline, reselect reverse thrust, and resume braking (Ref. FCTM 02.160).

The concept of equivalent runway condition is used to determine the maximum crosswind limitation. The following table indicates the maximum recommended crosswinds related to the reported braking actions:

Reported Braking Action	Reported Runway Friction Coefficient	Equivalent Runway Condition	Maximum Crosswind (knots)
Good/Medium	0.39 to 0.36	1	27
Medium	0.35 to 0.3	2/3	20
Medium/Poor	0.29 to 0.26	2/3	20
Poor	≤0.25	3/4	15
Unreliable	-	4/5	5 (*)

(\*) The maximum crosswind for the A330 is not defined, if the reported braking action is not reliable.



	<b>SUPPLEMENTARY INFORMATION</b>	04.010
	<b>ADVERSE WEATHER</b>	JAN 09/07

### **TAXI-IN**

During taxi-in, after landing, the flaps/slats should not be retracted. This is because retraction could cause damage, by crushing any ice that is in the slots of the slats. When the aircraft arrives at the gate, and the engines are stopped, a visual inspection should be performed to check that the slats/flaps areas are free of contamination. They may then be retracted, with the electric pumps.

### **PARKING**

At the end of the flight, in extreme cold conditions, cold soak protection is requested when a longer stopover is expected.

### **TURBULENCE**

R MSN 0002-0860

### **PREFACE**

The flight crew must use weather reports and charts to determine the location and altitude of possible CBs, storms, and Clear Air Turbulence (CAT). If turbulence is expected, the flight crew must turn on the seatbelt signs, in order to prepare passengers and prevent injury.

### **TAKEOFF**

For takeoff in high turbulence, the flight crew must wait for the target speed + 20 knots (limited to VFE-5) before retracting the slats/flaps (e.g. the flight crew must wait for F+20 knots before setting Flaps 1).

### **IN FLIGHT**

#### **USE OF THE RADAR**

Areas of known turbulence, associated with CBs, must be avoided. Good management of the radar tilt is essential, in order to accurately assess and evaluate the vertical development of CBs. Usually, the gain should be left in AUTO. However, selective use of manual gain may help to assess the general weather conditions. Manual gain is particularly useful, when operating in heavy

	<b>SUPPLEMENTARY INFORMATION</b>	04.010
	<b>ADVERSE WEATHER</b>	JAN 09/07

rain, if the radar picture is saturated. In this case, reduced gain will help the flight crew to identify the areas of heaviest rainfall, that are usually associated with active CB cells. After using manual gain, it should be reset to AUTO, in order to recover optimum radar sensitivity. A weak echo should not be a reason for the flight crew to underestimate a CB, because only the wet parts of the CB are detected. The decision to avoid a CB must be taken as early as possible, and lateral avoidance should, ideally, be at 20 nautical miles upwind.

#### **USE OF THE AP AND A/THR**

If moderate turbulence is encountered, the flight crew should set the AP and A/THR to ON with managed speed.

If severe turbulence is encountered, the flight crew should keep the AP engaged. Thrust levers should be set to turbulence N1 (Refer to QRH), and the A/THR should then be disconnected. Use of the A/THR is, however, recommended during approach, in order to benefit from the GS mini.

If the aircraft is flown manually, the flight crew should be aware of the fact that flight control laws are designed to cope with turbulence. Therefore, they should avoid the temptation to fight turbulence, and should not over-control the sidestick.

In some cases (e.g. A340 aircraft), and/or with heavy weights, turbulence speed may be less than the green dot speed. The turbulence speed must be flown for structural reasons. Green dot speed is not a limitation, but merely a maneuver speed and the flight crew may fly below this speed.

#### **VMO/MMO EXCEEDANCE**

In turbulence, during climb, cruise or descent, the aircraft may slightly exceed VMO/MMO with the autopilot (AP) engaged.

To prevent such an exceedance, adapt speed or Mach target.

If severe turbulence is known or forecasted, consider the use of turbulence speed.

If the current speed is close to the VMO (maximum operating speed), monitor the speed trend symbol on the PFD.

If the speed trend reaches, or slightly exceeds, the VMO limit:

- . Use the FCU immediately to select a lower speed target.

If the speed trend significantly exceeds the VMO red band, without high speed protection activation:

- . Select a lower target speed on the FCU and, if the aircraft continues to accelerate, consider disconnecting the AP.
- . Before re-engaging the AP, smoothly establish a shallower pitch attitude.

	<b>SUPPLEMENTARY INFORMATION</b>	04.010
	<b>ADVERSE WEATHER</b>	JAN 09/07

If the aircraft accelerates above VMO with the AP engaged, the AP will disengage on reaching the high speed protection. The high speed protection will apply a nose-up order up to 1.75 g, in addition to pilot input during VMO recovery. Therefore, make a smooth pitch correction in order to recover proper speed.

Speedbrakes may be used in case of high speed exceedance, but the flight crew should be aware of pitch influence. In addition, speedbrakes will be used with caution, close to the ceiling.

High Speed Protection may also result in activation of the angle of attack protection.

In all events, check the AP engagement status, and re-engage it when appropriate. It may have tripped and the associated aural warning may have been superseded by the overspeed aural warning.

#### **CONSIDERATIONS ON CLEAR AIR TURBULENCE (CAT)**

Clear Air Turbulence (CAT) can be expected by referring to weather charts and pilot reports. However, the radar cannot detect CAT, because it is "dry turbulence".

If CAT is encountered, the flight crew may consider avoiding it vertically, keeping in mind that the buffet margin reduces as the altitude increases.

#### **MISCELLANEOUS**

- . The flight crew must set the harness to on, check that the seat belts signs are on and use all white lights in thunderstorms.
- . Turbulence speeds are indicated in the QRH.
- . It is not necessary to set the ENG START selector to IGN. In the case of an engine flameout, the igniters will trigger automatically.
- . The handling characteristics of "fly-by-wire" aircraft are independent of the CG in normal and alternate law. Therefore, it is not necessary to command a FWD fuel transfer, in the event of heavy turbulence in cruise.

#### **WINDSHEAR**

R MSN 0002-0860

#### **BACKGROUND INFORMATION**

## WINDSHEAR PHENOMENON

Windshear is mainly due to a cool shaft of air, like a cylinder with a width between 0.5 nm and 1.5 nm, that is moving downward. When the air hits the ground, it:

- . Mushrooms horizontally, causing horizontal wind gradient
- . Curls inward at the edges, causing vertical air mass movement.

Flight safety is affected, because:

- . The horizontal wind gradient significantly affects lift, causing the aircraft to descend, or to reach a very high AOA.
- . The vertical air mass movement severely affects the aircraft flight path.

### WINDSHEAR PHENOMENON

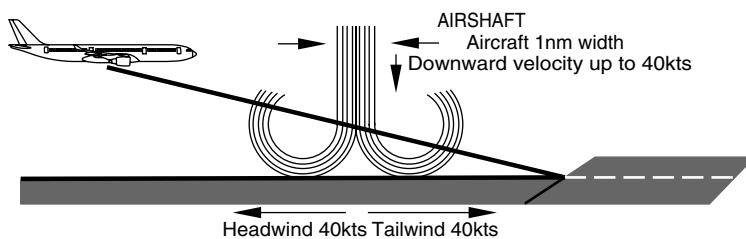

FOF 04010 03758 0001

## AWARENESS AND AVOIDANCE

Awareness of the weather conditions that cause windshear will reduce the risk of an encounter. Studying meteorological reports and listening to tower reports will help the flight crew to assess the weather conditions that are to be expected during takeoff or landing.

If a windshear encounter is likely, the takeoff or landing should be delayed until the conditions improve, e.g. until a thunderstorm has left the airport.

## STRATEGY FOR COPING WITH WINDSHEAR

Windshear and microburst are hazardous phenomena for an aircraft at takeoff or landing. The strategy to cope with windshear is:

- . **Increasing Flight Crew Awareness** through the Predictive Windshear System (PWS)

- **Informing the Flight Crew** of unexpected air mass variations through FPV and approach speed variations
- **Warning the flight crew** of significant loss of energy through "SPEED, SPEED" and "WINDSHEAR" aural warnings
- **Providing effective tools** to escape the shear through ALPHA FLOOR protection, SRS pitch order, high AOA protection and Ground Speed (GS) mini protection.

**Increasing Flight Crew Awareness**

When the airshaft of a microburst reaches the ground, it mushrooms outward, carrying with it a large number of falling rain droplets. The radar can measure the speed variations of the droplets, and as a result, assess wind variations. This predictive capability to assess wind variations is performed by the Predictive Windshear System (PWS). The PWS operates automatically below 2300 ft AGL, regardless of whether the radar is turned on or off.

**Informing the Flight Crew**

The FPV associated with the approach speed variations (GS mini protection) is an effective means for informing the flight crew of unexpected air mass variations:

Approach speed variations and lateral FPV displacement reflect horizontal wind gradient. Vertical FPV displacement reflects the vertical air mass movement.

BIRD AND TARGET SPEED - WIND INTERPRETATION

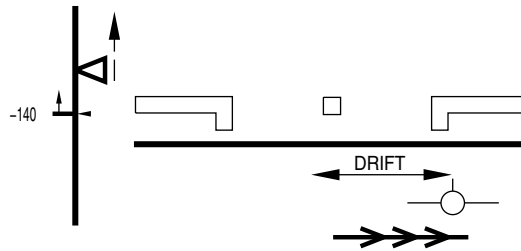

FOF 04010 03761 0001

	<b>SUPPLEMENTARY INFORMATION</b>  ADVERSE WEATHER	04.010
		JAN 09/07

### Warning the Flight Crew

The "SPEED, SPEED" low energy warning is based on the aircraft speed, acceleration and flight path angle. This warning attracts the PFs eyes to the speed scale, and requests rapid thrust adjustment. In windshear conditions, it is the first warning to appear, before the activation of the alpha floor protection. The following table provides some typical values of the speed at which the warning could occur in two different circumstances.

Deceleration Rate	Flight Path Angle	Warning
-1 knots/second	-3 °	VLS - 7 knots
-1 knots/second	-4 °	VLS - 1 knots

In addition, the aircraft has a reactive windshear warning system. This system triggers if the aircraft encounters windshear. In such a case, there is a "WINDSHEAR WINDSHEAR WINDSHEAR" aural warning.

### Providing Effective Tools

There are three effective tools to assist the flight crew to escape:

- . The alpha floor protection
- . The SRS AP/FD pitch law
- . The high angle-of-attack protection.

When the alpha floor protection is triggered, the A/THR triggers TOGA on all engines. The FMA displays A.FLOOR, that changes to TOGA LK, when the aircraft angle-of-attack has decreased. TOGA/LK can only be deselected by turning the A/THR off.

The SRS pitch mode ensures the best aircraft climb performance. Therefore, the procedure requests following the SRS pitch bar and possibly full aft stick, in order to follow the SRS orders and minimize the loss of height.

The high angle-of-attack protection enables the PF to safely pull full aft stick, if needed, in order to follow the SRS pitch order, or to rapidly counteract a down movement. This provides maximum lift and minimum drag, by automatically retracting the speed brakes, if they are extended.

R (3)

### OPERATIONAL RECOMMENDATIONS

#### TAKEOFF

	<b>SUPPLEMENTARY INFORMATION</b>	04.010
	<b>ADVERSE WEATHER</b>	JAN 09/07

### **Predictive Windshear ("WINDSHEAR AHEAD" aural warning)**

If a predictive windshear aural warning is generated on the runway before takeoff, takeoff must be delayed.

If a predictive windshear aural warning is generated during the takeoff roll, the Captain must reject the takeoff (the aural warning is inhibited at speeds greater than 100 knots).

If a predictive windshear aural warning is generated during initial climb, the flight crew must:

- . Set TOGA
- . Closely monitor the speed and the speed trend
- . Ensure that the flight path does not include areas with suspected shear
- . Change the aircraft configuration, provided that the aircraft does not enter windshear.

### **Reactive windshear ("WINDSHEAR, WINDSHEAR, WINDSHEAR" aural warning) or windshear detected by pilot observation**

If the windshear starts before V1, with significant speed and speed trend variations, and the Captain decides that there is sufficient runway to stop the airplane, the Captain must initiate a rejected takeoff.

If the windshear starts after V1, the flight crew must select TOGA and must apply the QRH checklist actions from memory. The following points should be stressed:

- . The configuration should not be changed until the aircraft is definitely out of the shear, because operating the landing gear doors causes additional drag.
- . The PF must fly SRS pitch orders rapidly and smoothly, but not aggressively, and must consider the use of full backstick, if necessary, to minimize height loss.
- . The PNF should call out the wind variations from the ND and V/S and, when clear of the shear, report the encounter to ATC.
- . For a DRT takeoff, asymmetric TOGA thrust cannot be applied, if the speed is less than F in CONF 2 or 3, due to VMCA considerations.

## **APPROACH**

	<b>SUPPLEMENTARY INFORMATION</b>	04.010
	<b>ADVERSE WEATHER</b>	JAN 09/07

### Predictive Windshear

In case the "MONITOR RADAR DISPLAY" is displayed or the ADVISORY ICON appears, the flight crew should either delay the approach or divert to another airport. However, if the approach is continued, the flight crew should consider the following:

- . The weather severity must be assessed with the radar display.
- . A more appropriate runway must be considered.
- . A CONF 3 landing should be considered
- . Managed speed should be used, because it provides the GS mini function.
- . The flight crew should increase the VAPP displayed on MCDU PERF APP page up to a maximum VLS + 15 knots.
- . Using the TRK/FPA or ILS, for an earlier detection of vertical path deviation should be considered.
- . In very difficult weather conditions, the A/THR response time may not be sufficient to manage the instantaneous loss of airspeed. The applicable technique is described in the FCTM 02.100 - USE OF A/THR.
- . In case the "GO AROUND WINDSHEAR AHEAD" message is triggered, the PF must set TOGA for go-around. The aircraft configuration can be changed, provided that the windshear is not entered. Full back stick should be applied, if required, to follow the SRS or minimize loss of height.

### Reactive Windshear

In case of the "WINDSHEAR WINDSHEAR WINDSHEAR" aural warning, the PF must set TOGA for go-around. However, the configuration (slats/flaps, gear) must not be changed until out of the shear. The flight crew must closely monitor the flight path and speed.

## VOLCANIC ASH

R MSN 0002-0860

R (4)

### PREFACE



	<b>SUPPLEMENTARY INFORMATION</b>	04.010
	<b>ADVERSE WEATHER</b>	JAN 09/07

Volcanic ash or dust consists of very abrasive particles, that may cause engine surge and severe damage to aircraft surfaces that are exposed to the airflow. For this reason, operations in volcanic ash must be avoided. However, if such operations cannot be avoided, the operators should apply the following recommendations.

## **GROUND OPERATIONS**

### **PRELIMINARY COCKPIT PREPARATION**

The use of APU should be avoided whenever possible, and the use of the Ground Power Unit (GPU) should be preferred. The wipers must not be used for any reason.

### **EXTERIOR INSPECTION**

Maintenance personnel must remove ash that has settled on exposed lubricated surfaces that can penetrate seals or enter the engine gas path, air conditioning system, air data probes and other orifices on the aircraft. They must clean the engines air inlet of any volcanic ash. In addition, they must clean the 25-foot area around the engine inlet.

### **ENGINE START**

The use of an external pneumatic supply should be preferred, when possible. If this is not possible, the APU can be used to start the engines.

Before starting the engines, the flight crew must use dry cranking. This will blow out any ash that may have entered the booster area.

### **TAXI**

The flight crew must move forward the thrust levers smoothly to the minimum required thrust to taxi, and must avoid any sharp or high-speed turns. The bleeds must be kept OFF.

### **TAKEOFF**

It is advisable to use the rolling takeoff technique, and apply smooth thrust.

## **IN FLIGHT**

### **CRUISE**

The flight crew must avoid flying into areas of known volcanic ash. If a volcanic eruption is reported, while the aircraft is in flight, the flight must be rerouted to remain clear of the affected area. The volcanic dust may spread over several hundred miles. Whenever possible, the flight crew should stay on the upwind side of the volcano.

Depending on outside conditions (night flight, clouds), volcanic dust may not be visible. However, several phenomena can indicate that the aircraft is flying through ash cloud, for example:

- . Smoke or dust in the cockpit
- . Acrid odour, similar to electrical smoke
- . Engine malfunction, e.g. a rising EGT
- . At night, the appearance of St Elmo fire, bright white or orange glow appearing in engine inlets or sharp and distinct beams from the landing lights.

If an ash cloud is encountered, the applicable procedure is described in the QRH. The essential actions to be taken are:

- . A 180-degree turn, if possible. This is the quickest way to escape, because the ash cloud lateral dimension is not known
- . Protecting the engines:
  - Set A/THR to OFF
  - Decrease engines thrust, if possible and maximize the engine bleed to increase the engine surge margin
  - Start the APU for further engine restart, if required.
- . Protecting the flight crew and passengers:
  - Don the oxygen mask
  - Consider oxygen for the passengers.
- . Monitoring the flight parameters:
  - Monitor the EGT and fuel flow, because an engine part may be eroded
  - Monitor and crosscheck the IAS, because an IAS indication may be corrupted.

A diversion to the nearest appropriate airport should be considered.

## LANDING

The use of reverse should be avoided, unless necessary.

	<b>SUPPLEMENTARY INFORMATION</b>	04.010
	ADVERSE WEATHER	JAN 09/07

### HIGHLIGHTS

- (1) There is no request to report to maintenance in case of prolonged flight in icing conditions
- (2) Harmonization with FCOM: engine anti-ice must be ON in descent when SAT is below -40 °C.
- (3) Minor wording change
- (4) Harmonization with FCOM procedure: selecting ignition is not necessary, since the engine is fitted with an autorelight system.

## GENERAL

R MSN 0002-0860

Two flight references may be used on the PFD:

- . The attitude
- . The Flight Path Vector (FPV), called the "bird".

The pilot selects the flight reference with the HDG/VS TRK/FPA pb on the FCU.

## THE ATTITUDE

R MSN 0002-0860

When HDG/VS is selected on the FCU, the "bird" is off, and the attitude is the flight reference, with HDG and VS as basic guidance parameters.

The attitude flight reference should be used for dynamic maneuvers, for example, takeoff or go-around. An action on the sidestick has an immediate effect on the aircraft attitude. The flight crew can monitor this flight reference directly and accurately during these maneuvers.

## THE FLIGHT PATH VECTOR

R MSN 0002-0860

When TRK/FPA is selected on the FCU, the "bird" (the FPV) is the flight reference with the TRK and FPA as basic guidance parameters.

In dynamic maneuvers, the "bird" is directly affected by the aircraft inertia and had a delayed reaction. As a result, the "bird" should not be used as a flight reference in dynamic maneuvers.

The "bird" is the flight reference that should be used when flying a stabilized segment of trajectory, e.g. a non-precision approach or visual circuit.

**INFORMATION PRESENTATION**

The FPV appears on the PFD as a symbol, known as "the bird". The bird indicates the track and flight path angle in relation to the ground.

The track is indicated on the PFD by a green diamond on the compass, in addition to the lateral movement of the bird in relation to the fixed aircraft symbol. On the ND, the track is indicated by a green diamond on the compass scale. The difference in angle between track and heading indicates the drift.

The flight path angle is indicated on the PFD by the vertical movement of the bird in relation to the pitch scale.

**USE OF FPV**

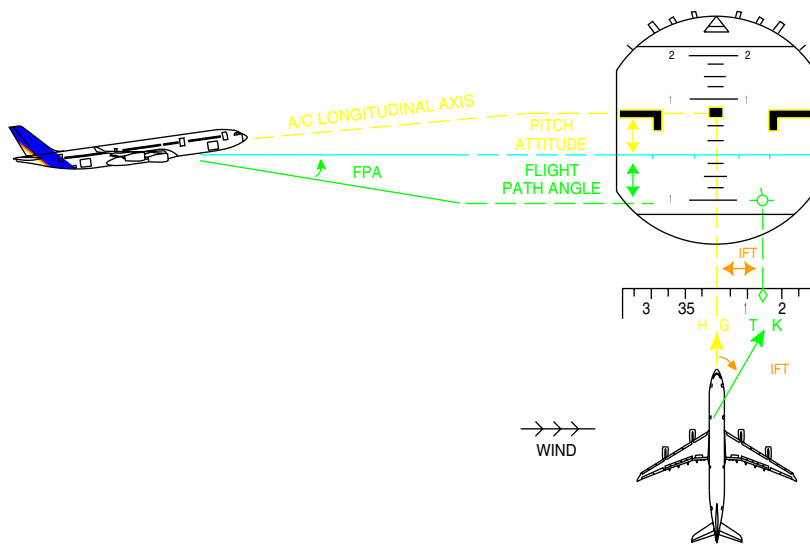

FOF 04020 03753 0001

With the Flight Directors (FDs) selected on, the Flight Path Director (FPD) replaces the HDG-VS Flight Director (FD). With both FDs pb set to off, the blue track index appears on the PFD horizon.

**PRACTICAL USES OF THE FPV**

As a general rule, when using the bird, the pilot should first change attitude, and then check the result with reference to the bird.

	<b>SUPPLEMENTARY INFORMATION</b>	04.020
	FLYING REFERENCE	JAN 09/07

## NON-PRECISION APPROACH

The FPV is particularly useful for non-precision approaches. The pilot can select values for the inbound track and final descent path angle on the FCU. Once established inbound, only minor corrections should be required to maintain an accurate approach path. The pilot can monitor the tracking and descent flight path, with reference to the track indicator and the bird.

However, pilots should understand that the bird only indicates a flight path angle and track, and does not provide guidance to a ground-based radio facility. Therefore, even if the bird indicates that the aircraft is flying with the correct flight path angle and track, this does not necessarily mean that the aircraft is on the correct final approach path.

## VISUAL CIRCUITS

The FPV can be used as a cross-reference, when flying visual circuits. On the downwind leg, the pilot should position the wings of the bird on the horizon, in order to maintain level flight. The downwind track should be set on the FCU. The pilot should position the tail of the bird on the blue track index on the PFD, in order to maintain the desired track downwind.

On the final inbound approach, the track index should be set to the final approach course of the runway. A standard 3° approach path is indicated, when the top of the bird's tail is immediately below the horizon, and the bottom of the bird is immediately above the 5° nose down marker

### USE OF FPV IN FINAL APPROACH

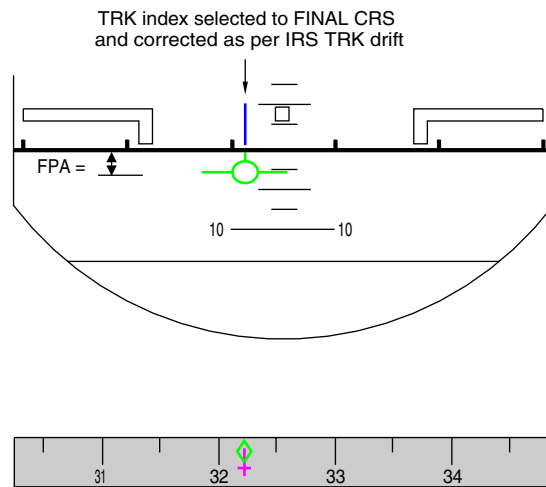

FOF 04020 03754 0001

### FINAL APPROACH

The bird is a very useful flight reference, because it provides the trajectory parameters, and quickly warns the pilot of downburst. In addition, together with the GS MINI protection, it is an excellent indicator of shears or wind variations. If nothing else, the position of the "bird" in relation to the fixed aircraft symbol provides an immediate indication of the wind direction. Therefore, when approaching the minima, the pilot knows in which direction to search for the runway.

The target approach speed symbol moves upward, indicating that there is headwind gust. The bird drifts to the right, indicating that there is wind from the left.

### GRAPHIC SOLUTION TITLE

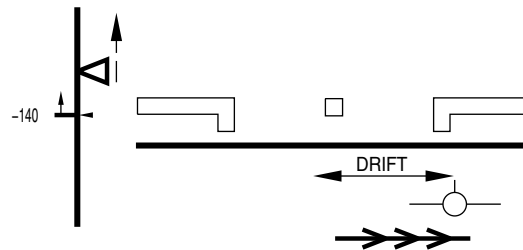

FOF 04010 03761 0001

## **RELIABILITY**

The FPV is computed from IRS data, therefore, it is affected by ADIRS errors. An error may be indicated by a small track error, usually of up to  $\pm 2^\circ$ . This can be easily determined during the approach.

The FPV is also computed from static pressure information. Therefore, the bird must be considered as not reliable, if altitude information is not reliable.

## **GO AROUND**

R MSN 0067-0069 0072-0073 0077 0089-0090 0095 0100-0101 0104 0107 0110 0116-0117 0119 0143 0151 0212 0215 0230 0276 0281 0286-0287 0315 0323 0333-0334 0337 0340-0342 0370 0375 0380 0388

For the go-around, the appropriate flight reference is the attitude, because go-around is a dynamic maneuver. Therefore, if the "bird" is on, the PF will ask the PNF to select HDG/VS, in order to recover the FD bars.

R MSN 0002-0066 0070-0071 0074-0076 0078-0088 0091-0094 0096-0099 0102-0103 0106 0109 0111-0115 0118 0120-0142 0144-0150 0152-0211 0213-0214 0216-0229 0231-0275 0277-0280 0282-0285 0288-0314 0316-0322 0324-0332 0335 0338-0339 0343-0369 0371-0374 0376-0379 0381-0387 0389-0860

For the go-around, the appropriate flight reference is the attitude, because go-around is a dynamic maneuver. Therefore, when performing a go-around, regardless of the previously-selected flight reference, upon selection of TOGA, the FD bars are automatically restored in SRS/GA TRK modes, and the "bird" is automatically removed.



	<b>SUPPLEMENTARY INFORMATION</b>  NAVIGATION ACCURACY	04.030
		JAN 09/07

## GENERAL

R MSN 0002-0860

The primary function of the FMS is navigation, i.e. to compute the aircraft's position as accurately as possible. The validity of all other functions depends on the accuracy of the FMS position.

The accuracy of the FMS navigation determines the flight crew's strategy for using the AP/FD modes, in addition to the ND display.

## COMPUTATION OF THE AIRCRAFT POSITION

R MSN 0002-0860

### WITHOUT GPS PRIMARY

#### PRINCIPLE

The FMS position is computed from the three IRS positions, that are combined to provide a MIX IRS position. The radio position is also combined, if two DMEs, a VOR/DME or a GPS supplemental are available. The GPS supplemental is considered to be an additional form of NAVAID, and can be accepted, if it falls within the radio position or the MIX IRS position.

#### INITIALIZATION

Refer to the FCTM 02.001.

#### TAKEOFF

Each FMGC uses the MIX IRS position as its position, until the thrust levers are pushed forward to TOGA. The FMS position is then updated to the runway threshold coordinates. The difference between the MIX IRS position and the FMS position is referred to as the TO BIAS. The TO BIAS is added to the MIX IRS position, for the subsequent FMS position.

#### FMS POSITION UPDATING AT TAKE OFF

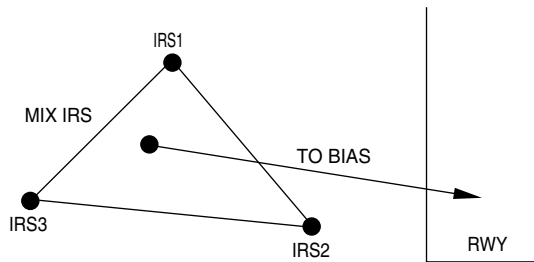

FOF 04030 03793 0001

**IN FLIGHT**

The original TO BIAS is continuously updated with the current radio aid.

UPDATING BIAS PRINCIPLE

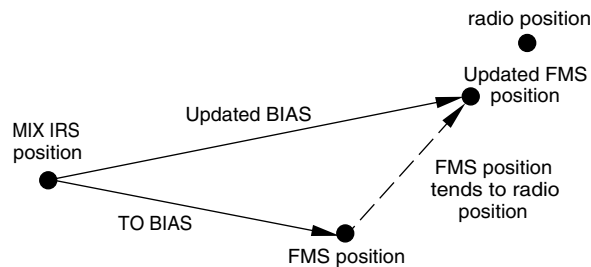

FOF 04030 03794 0001

If the radio position is lost, the system uses the updated BIAS to determine the FMS position from the MIX IRS position.

**NAVIGATION ACCURACY**

The FMS computes the Estimated Position Error (EPE). The EPE is an estimate. To compute the EPE, the FMS considers the immediately available navigation means in the FMS position computation and applies defined tolerances for each of them. These tolerances assume that the navigation means are working properly. They ignore any possible excessive IRS drift or erroneous locations of nav aids. The MCDU PROG page displays the HIGH/LOW indications, according to the EPE. These indications reflect the probable accuracy of the FMS navigation compared to the determined accuracy criteria.

WITH GPS PRIMARY

	<b>SUPPLEMENTARY INFORMATION</b>  NAVIGATION ACCURACY	04.030
		JAN 09/07

**PRINCIPLE**

The GPS interfaces directly with the IRS that outputs a GPIRS position. When a GPIRS position is available, it overrides the RADIO position, if available. Therefore, the FMS position tends toward the GPIRS position.

**INITIALIZATION**

Refer to the FCTM 02.001.

**TAKEOFF**

The FM position is automatically updated at the runway threshold. With FMS2, this automatic position update is inhibited.

**IN FLIGHT**

The FM position tends to the GPIRS position as long as the GPS satellites are available.

**NAVIGATION ACCURACY**

The GPS position is characterized by two parameters:

- . Integrity
- . Accuracy.

Integrity is a direct function of the number of satellites in view of the aircraft. If five or more satellites are in view, several combinations of the satellite signal may be used to process "several positions" and to carry out reasonableness tests on the satellite signals themselves.

Accuracy functions in direct connection with the satellite constellation in view of the aircraft. If the satellites are low on horizon, or not in appropriate positions, accuracy will be poor. It is provided as a "figure of merit".

If the GPS position fulfils both the integrity and the accuracy criteria, GPS PRIMARY is displayed on the MCDU PROG page and the GPS position is the best raw data position available.

**SUMMARY**

	FM POSITION	
Flight phase	WITHOUT GPS PRIMARY	WITH GPS PRIMARY

	<b>SUPPLEMENTARY INFORMATION</b>  NAVIGATION ACCURACY	04.030
		JAN 09/07

On ground before Takeoff		MIX IRS	GP IRS
Takeoff		Updated at runway threshold (shift) (*)	
In flight	With RADIO	Tends toward RADIO	GP IRS
	Without RADIO	MIX IRS + BIAS	GP IRS

(×) With FMS2, the FMS position update at takeoff is inhibited, when GPS PRIMARY is active.

**USE OF FMS**

R MSN 0002-0860

The navigation accuracy is managed through several MCDU pages:

**PROG PAGE**

This page indicates the GPS PRIMARY.

The PROG displays the estimated navigation accuracy in green. This provides the EPE, if GPS PRIMARY LOST, or is computed by the GPS, if GPS PRIMARY is displayed

The PROG page displays the required navigation accuracy in blue (this can be changed). The required navigation accuracy thresholds are determined, depending on the flight phase, or can be manually entered. These thresholds are used to change from HIGH to LOW accuracy, or vice versa. These indications are used when flying within RNP airspace.

**SELECTED NAVAIDS PAGE**

The SELECTED NAVAID page is accessible from DATA/POSITION MONITOR/FREEZE/SEL NAVAIDS. It has a DESELECT prompt, that enables the flight crew to prevent the FMS from using the GPS data to compute the position, in the case of a major problem. GPS PRIMARY lost is then displayed on MCDU and ND. The GPS can be reselected using the same page.

**PREDICTIVE GPS PAGE (IRS HONEYWELL ONLY)**

	<b>SUPPLEMENTARY INFORMATION</b>  NAVIGATION ACCURACY	04.030
		JAN 09/07

The PREDICTIVE GPS page is accessible from PROG page. The GPS PRIMARY criteria depend upon the satellite constellation status (position and number) and this is predictable. The crew can assess the GPS PRIMARY status at destination or alternate.

### **ND/MCDU**

A GPS PRIMARY message is displayed when GPS PRIMARY is again available. This message is clearable. A GPS PRIMARY LOST message is displayed when GPS PRIMARY is lost. This message is clearable on MCDU but not on ND. When the class of navigation accuracy is downgraded from HIGH to LOW (LOW to HIGH), a NAV ACCUR DOWNGRADE (UPGRADE) is displayed on ND and MCDU

## **AIRCRAFT POSITION AWARENESS AND OPERATIONAL CONSEQUENCES**

R MSN 0002-0860

R (1)

### **NAVIGATION ACCURACY INDICATIONS**

The navigation accuracy indications are available on the MCDU PROG page. The following guidelines apply:

- . If GPS PRIMARY is displayed, no navigation cross-check is required
- . If GPS PRIMARY LOST, navigation crosscheck is required in climb, in cruise, about every 45 minutes, before the Top Of Descent, reaching TMA and IAF and whenever a navigation doubt occurs.
- . The crew will use, IRS only, LOW and NAV ACCY DNGRADED messages as indications to trigger a navigation accuracy check.

### **NAVIGATION ACCURACY CROSSCHECK TECHNIQUE**

R (2)

The principle consists in comparing the FMS position with the RADIO position (aircraft real position).

#### **NAVIGATION ACCURACY CROSS CHECK TECHNIQUE 1**

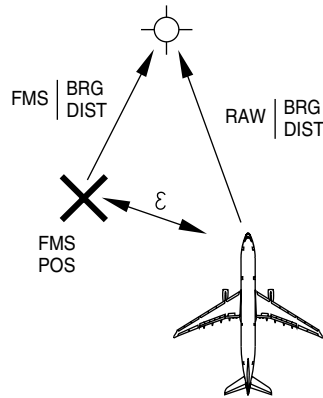

FOF 04030 03798 0001

There are two possible techniques:

- The flight crew inserts a radio ident in the MCDU PROG page that provides a bearing/distance in relation to the FMS position. They then compare these values with the raw data received from the navaid, that indicates the real position of the aircraft. This enables the flight crew to quantify the error .
- On the ND, the flight crew compares: The position of the needle and its associated DME distance (the real position of the aircraft) with the position of the navaid symbol and its associated distance, indicated by the range markers (these markers provide a bearing/distance, in relation to the FMS position).

R (3)

NAVIGATION ACCURACY CROSS CHECK TECHNIQUE 2

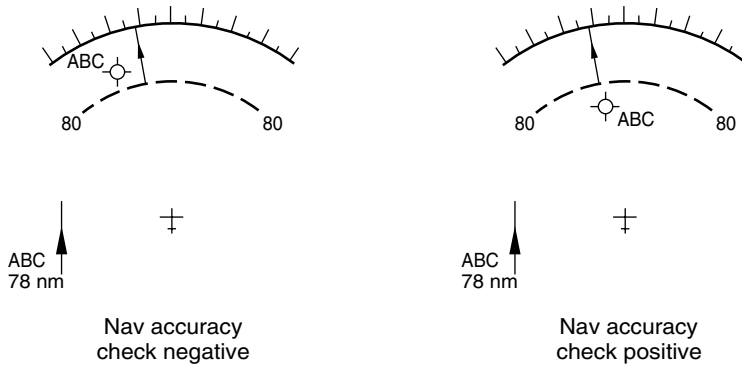

FOF 04030 00201 0001

	<b>SUPPLEMENTARY INFORMATION</b>  NAVIGATION ACCURACY	04.030
		JAN 09/07

### OPERATIONAL CONSEQUENCES

The result of the crosscheck of the navigation accuracy determines the pilot's strategy for using the ND display, the AP/FD modes and the EGPWS.

			ND		AP/FD mode	EGPWS
			PF	PNF		
GPS PRIMARY		-	Arc or Rose NAV with raw data when required		Lateral and vertical managed modes	ON
GPS PRIMARY LOST Or No GPS	Cruise	Navigation accuracy check positive ( $\leq 3$ nm)	Arc or Rose NAV with raw data when required		Lateral and vertical managed modes	ON
		Navigation accuracy check negative ( $>3$ nm)	ARC or ROSE NAV may be used with care and with raw data		Lateral and vertical managed modes with care with raw data	OFF
	Ap-proach	Navigation accuracy check positive ( $\leq 1$ nm)	Arc or Rose NAV with raw data		Lateral and vertical managed modes	ON
		Navigation accuracy check negative ( $>1$ nm)	ROSE VOR or ILS as required		Lateral and vertical selected modes	OFF

(1) A GPS-defined Non-Precision Approach must be interrupted, if the GPS PRIMARY LOST message is displayed.

### POSITION UPDATE

In the case of an obvious and major map shift, indicated by messages, such as "CHECK A/C POSITION, FM1/FM2 POS MISMATCH", the aircraft position may be updated on the MCDU PROG page. There are two possible techniques:

The recommended technique is to update the FMS over a beacon by pressing the UPDATE prompt once estimating that the aircraft overflies the beacon using the associated needle. The potential error induced is approximately 4 to 5 NM. When the position update is achieved, the EPE is automatically set to a higher value and the navigation accuracy is low.

The second technique consists of updating the FM position, when flying over a Point/Bearing/Distance (P/B/D) with reference to beacon raw data (Needle + Distance) rather than the beacon itself. The potential for error is far less when the distance is greater than 60 nm. The flight crew will keep in mind the potential 180 degree error on bearing.

FM POSITION UPDATE IN FLIGHT

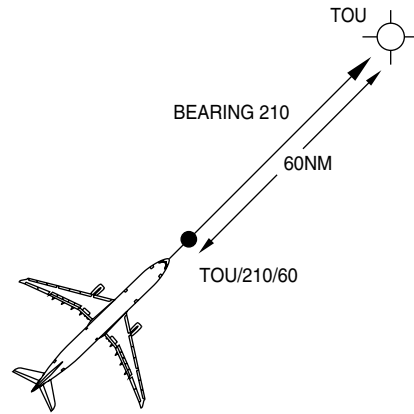

FOF 04030 03800 0001



	<b>SUPPLEMENTARY INFORMATION</b>  NAVIGATION ACCURACY	04.030
		JAN 09/07

**HIGHLIGHTS**

- (1) Enhancement of the graph, to show an example with good accuracy
- (2) Deleted item 'Navigation accuracy cross check technique 2'
- (3) New item 'Navigation accuracy cross check technique 2' for 'MSN 0002-0860'

**GENERAL**

R MSN 0002-0860

Before engine start, the FMGC computes the aircrafts Gross Weight (GW) and Center of Gravity (CG). After engine start, both the Flight Envelope Computer (FE) and the Fuel Control and Monitoring Computer (FCMC) calculate the GW and CG.

These GW and CG values provide information for:

- . Aircraft GW and CG displays
- . FM predictions and speeds
- . The AP/FD and flight control laws
- . The calculation of the VS1G
- . The calculation of the characteristic speeds (VLS, F, S, GD), for display on the PFD
- . CG control

If a ZFW or ZFWCG is not correctly entered on the INIT B page of the MCDU, this results in calculation errors.

**TECHNICAL BACKGROUND**

R MSN 0002-0860

To calculate the GW and CG:

1. The pilot enters the ZFW and ZFWCG on the INIT B page of the MCDU.
2. The FCMC calculates the GW and CG by taking into account the ZFW and ZFWCG (entered on the INIT B page of the MCDU), and the quantity of fuel in each tank.  
The GW and CG, calculated by the FCMC, are:
  - . Used by the FCMC to regulate the center of gravity
  - . Transmitted to the ECAM SD for display
  - . Transmitted to the FE.
3. The FE transmits the GW and CG to the:
  - . FM, for predictions and speeds
  - . PRIM, for the computation of the VS1G and for flight control laws

- . FG, for the AP/FD control laws
- . EIS, for the display of characteristic speeds

Note:

The FE computes a backup:

- GW, with aerodynamic data or from Fuel Used (FU) data
- CG, with aerodynamic data, and the THS position.

If FCMC data are available, the GW and CG FCMC computed are used.

If FCMC data are not available, the GW and CG FE computed are used.

However, if the FCMC-computed CG, and the FE-computed CG differs more than a specified threshold, the PRIM uses 30% CG for flight control laws.

- . The FE uses VS1G from the PRIM to compute characteristic speeds (VLS, F, S, GD). These speeds are displayed on PFD.
- . For the calculation of ValphaPROT, ValphaMAX, and VSW, the PRIM uses AOA data only.

4. The FE-computed CG is used to trigger the Excess AFT CG warnings of the FWC. This works independently from the FCMC.

GW AND CG COMPUTATION AND USE

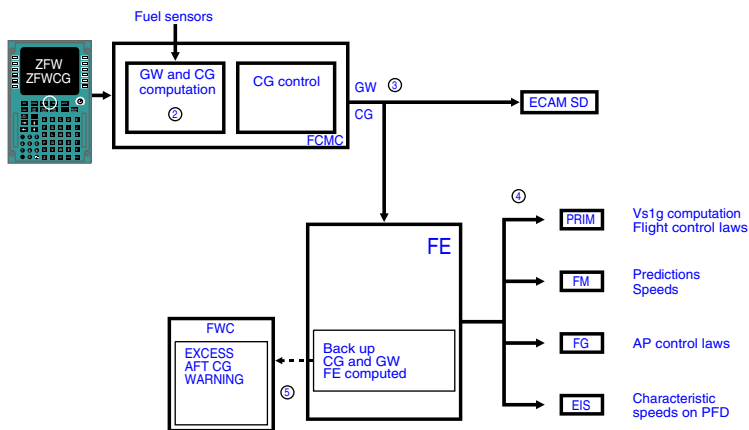

FOF 04040 03731 0001

	<b>SUPPLEMENTARY INFORMATION</b>  ZFW - ZFCG ENTRY ERRORS	04.040
		JAN 09/07

## ENTRY ERROR AND OPERATIONAL CONSEQUENCES

R MSN 0002-0860

The following summarizes the impact of erroneous ZFW or ZFWCG entries on the INIT B page of the MCDU:

### **ERRONEOUS ZFWCG ENTRY**

If the ZFWCG entry is not correct, the FCMC-computed CG will not be correct, and:

- . An erroneous CG appears on both the SD page of the ECAM, and on the FUEL PRED page of the MCDU.
- . Affects CG regulation.  
However, the EXCESS AFT CG warning remains reliable.
- . Slightly affects FM predictions.
- . Impacts the VLS and VAPP speeds, that appear on the PERF APPR page of the MCDU (A340-500/600 only).
- . The pitch trim setting may not be correct at takeoff.
- . The PRIM operates with a CG of 30% in flight.  
However, this will have a very small effect on aircraft handling.
- . Slightly affects AP/FD control laws.
- . Impacts the VLS that appears on the PFD (A340-500/600 only).

However, ValphaPROT, ValphaMAX, VSW are not affected, because they are calculated on the basis of aerodynamic data.

### **ERRONEOUS ZFW ENTRY**

If the ZFW entry is not correct, the FCMC-computed GW and, to a lesser degree, the CG will not be correct, and:

- . Erroneous GW and CG appear on both the ECAM and on the FUEL PRED page of the MCDU.
- . Slightly affects CG regulation, because the aft CG target depends on the weight. However the EXCESS AFT CG warning remains reliable.

	<b>SUPPLEMENTARY INFORMATION</b>	04.040
	ZFW - ZFCG ENTRY ERRORS	JAN 09/07

- . May affect the SRS guidance mode (If VLS is greater than the V2 that is entered on the PERF TO page of the MCDU).
- . Affects FM predictions and speeds.
- . Slightly affects FG and the PRIM control laws
- . Affects the characteristic speeds that appear on the PFD.

However, ValphaPROT, ValphaMAX, VSW are not affected, because they are calculated on the basis of aerodynamic data.

#### **ERRONEOUS FUEL ON BOARD (FOB) ENTRY**

If the FOB entry is not correct, the GW and will not be correct until the engines are started, and all of the above-mentioned consequences apply. When the engines are started, fuel figures are updated and applicable data is also updated accordingly.

#### **OPERATIONAL RECOMMENDATIONS**

R MSN 0002-0860

It is possible to limit the number of ZFW or ZFWCG entry errors by applying the following recommendations:

- . If the flight crew performs a manual refuelling, the flight crew should carefully check the CG calculation, because the load and trim sheet CG is calculated on the basis of the standard distribution of fuel.
- . Both flight crewmembers should crosscheck ZFW and ZFWCG entries.
- . The CG on the load and trim sheet should be compared with the CG on the ECAM.

If the flight crew detects a GW error in flight (e.g. a characteristic speeds error), then a GW update can be made via the FUEL PRED page of the MCDU.

## PREFACE

R MSN 0002-0860

The Center of Gravity (CG) is the point at which weight is applied. The CG is expressed as a percentage of the Mean Aerodynamic Chord (MAC). It must remain within a range determined by the CG's impact on the aircraft:

- . Performance
- . Structure
- . Handling characteristics (when in direct law).

These factors define the range that the CG must remain within. This range is referred to as the CG envelope.

R MSN 0002-0860

## MECHANICAL ASSUMPTIONS

For pitch control, there are three forces that must be considered when airborne:

- . The weight applied on the CG
- . The lift applied on the Center of Pressure (CP)
- . The downward force created by the Trimmable Horizontal Stabilizer (THS).

### FORCES APPLIED ON FLYING AIRCRAFT

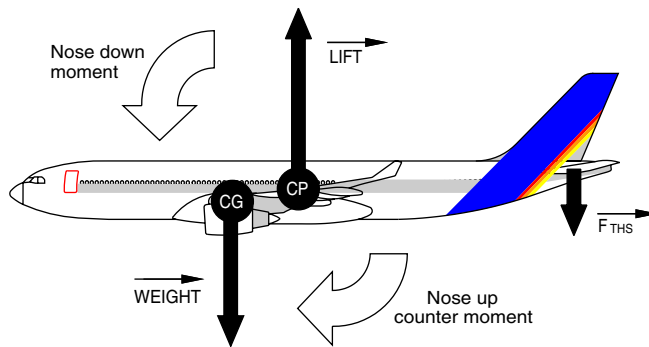

FOF 04050 03769 0001

Because the first two forces are not applied at the same point, they create a pitching moment, that must be counteracted by the THS setting.

### INFLUENCE OF THE CENTER OF GRAVITY ON THE AIRCRAFT PERFORMANCE

R MSN 0002-0860

The position of the CG has a significant impact on performance, because it determines the balance of the longitudinal forces.

When the CG moves forward, the nose down moment increases. The THS produces a greater downward force to counteract this moment. As a result, lift must increase, in order to balance both the weight and the THS downward force. Therefore, a forward CG will result in a greater stall speed value. On A330/A340, the stall speed increases by 1.5 knots, when the CG varies from 26% to full forward CG.

#### INFLUENCE OF THE CG POSITION

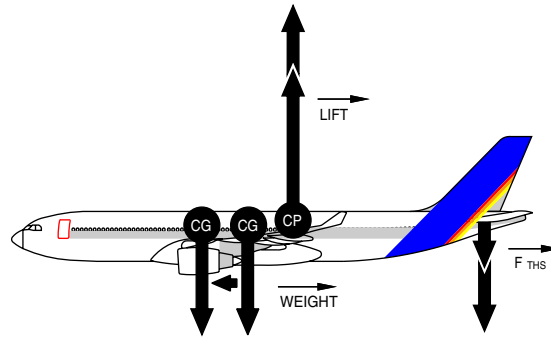

FOF 04050 03770 0001

**IMPACT ON TAKEOFF PERFORMANCE**

**TAKEOFF SPEED AND ASSOCIATED DISTANCES**

The aircraft operating speeds are referenced to the stall speed, e.g.  $V_2 > 1.13 V_{S1g}$ .

If the CG moves forward ►  $V_{S1g}$  increases ►  $V_2$  increases ► TOD increases (or the runway-limited TOW decreases).

**ROTATION MANEUVER**

An aft CG gives the aircraft a nose up attitude, that helps the rotation. A forward CG results in a nose heavy situation, and a difficult rotation. It is "heavier", therefore longer, at forward CG.

**CLIMB GRADIENT**

As mentioned above, a forward CG is counteracted by a greater THS downward force. This creates drag, that, in addition to the drag caused by the lift increase, degrades aircraft performance, for example, the climb gradient.

For example:

A340 Performance decrement with CG full forward, in comparison with CG 26% Conf. 3, Packs On, ISA, $Z_p=0$			
	CG 26 %	CG full forward	
TOD	3165 m	3241 m	76 m



	<b>SUPPLEMENTARY INFORMATION</b>	04.050
	CENTRE OF GRAVITY	JAN 09/07

5% Climb gradient limiting weight	257.6 t	256.2 t	1.4 t
-----------------------------------	---------	---------	-------

### **IMPACT ON IN-FLIGHT PERFORMANCE**

A forward CG causes a nose up counter moment, that degrades fuel consumption, because of increased induced drag. For low fuel consumption, it is better to the CG to be as far aft as possible.

Fuel increment 1000 NM stage length CG location at 20% (reference at 35%)	
Aircraft type	Fuel increment (kg/lb)
A330	220/485
A340	380/838

The result summarizes the worst cases, i.e. it considers an heavy aircraft at a high flight level.

Airbus has developed a trim tank transfer system, that controls the aircraft CG. When the airplane is in cruise, the system optimizes the CG to save fuel by reducing the drag on the airplane. The system either transfers fuel to the trim tank (aft transfer), or from the trim tank (forward transfer). This movement of fuel changes the CG. The flight crew can also manually select a forward fuel transfer. The Fuel Control and Management Computer (FCMC) calculates the CG of the aircraft, based on the ZFWCG and fuel distribution. It then compares the result to a target value. From this calculation, the FCMC determines the quantity of fuel to be moved aft or forward in flight (usually one aft fuel transfer is carried out during each flight).

### **IMPACT ON LANDING PERFORMANCES**

For landing, the aircraft operating speeds are referenced to the stall speed, i.e.  $V_{app} > 1.23 V_{S1g}$

If the CG moves forward ► VS increases ►  $V_{app}$  increases ► Landing Distance increases (or the Maximum Landing Weight, limited by landing distance, decreases).

## **INFLUENCE OF THE CG ON THE SRUCTURE AND HANDLING CHARACTERISTICS**

R MSN 0002-0860

	<b>SUPPLEMENTARY INFORMATION</b>	04.050
	CENTRE OF GRAVITY	JAN 09/07

## TAKEOFF AND LANDING

During the flights phases, that are critical and constraining, the CG must stay within certified limits for structural and handling qualities considerations (when in direct law). The following CG-certified envelope has been designed, in accordance with these limits:

### CG ENVELOPE

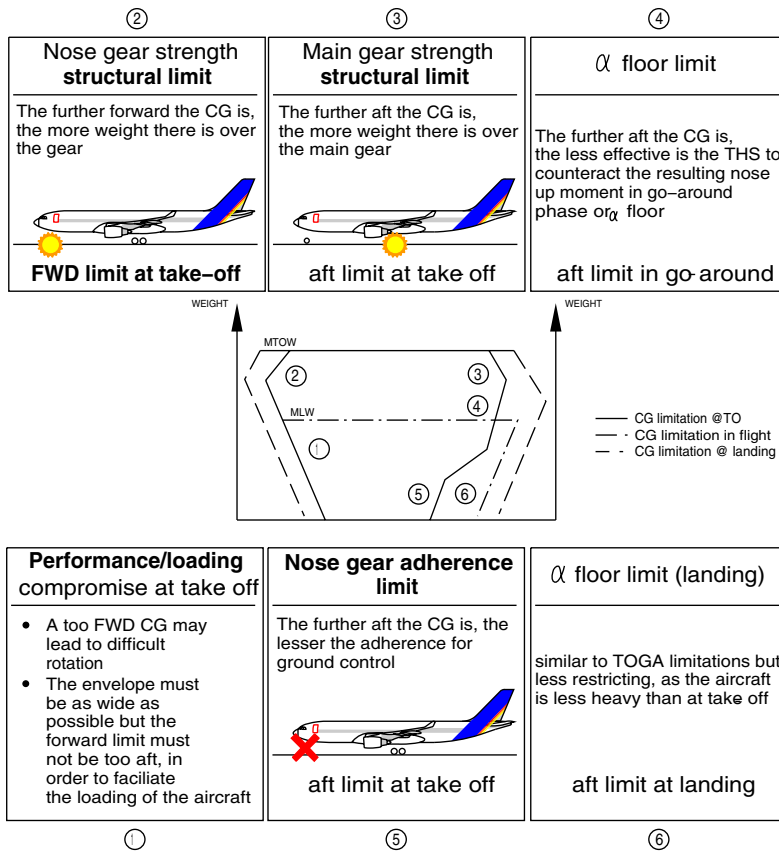

FOF 04050 03771 0001

The CG envelope must also allow passengers to move in the cabin. Therefore, when the takeoff CG and landing CG envelope have been determined, the in flight envelope is deducted from takeoff/landing CG envelope by adding a 2% margin, provided that all the criteria for the handling characteristics are met.

Note: In approach with flaps extended, there is a nose down moment. This is counteracted by THS nose up setting. The further forward the CG is, the more the THS nose up setting is required. This can result in a THS stall, particularly in cases of push over when the pilot pushes hard on the sidestick, in reaction to a significant speed decrease. This limits the forward CG during approach.

**IN FLIGHT**

On a fly-by-wire aircraft, in direct law, the handling characteristics are affected by the location of the CG, in the same way as in a mechanically controlled aircraft.

**STABILITY ISSUE THE AERODYNAMIC CENTER OR NEUTRAL POINT**

In case of a perturbation or a gust, the aircraft is considered as stable, if it tends to revert toward its previous status. The aerodynamic center or neutral point is the point where there is an increase (or decrease) of lift, when the aircraft angle-of-attack changes.

AIRCRAFT LONGITUDINAL STABILITY

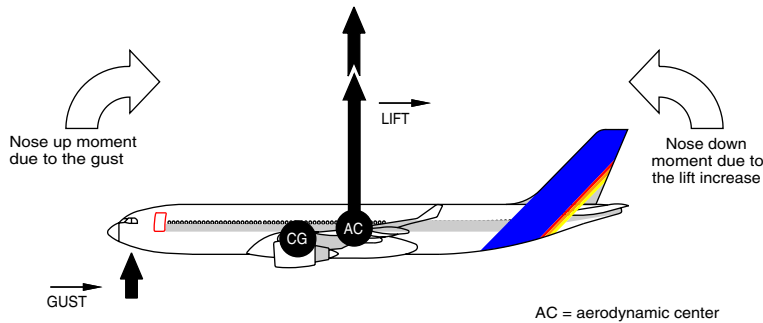

FOF 04050 03772 0001

The gust illustrated here causes an increase in the angle-of-attack, therefore an additional lift. The nose down moment, due to the lift increase, causes a decrease in the angle-of-attack. The aircraft is stable.

If the CG is behind the aerodynamic center, the increase in lift creates a nose up moment, that adds to the initial nose up moment caused by the gust. The aircraft is unstable.

The CG must be forward of the aerodynamic center for stability.

	<b>SUPPLEMENTARY INFORMATION</b>  CENTRE OF GRAVITY	04.050
		JAN 09/07

### MANEUVERING CRITERIA MANEUVER POINT

Depending on where the CG is, a deflection of the elevator causes a sharper, or less aircraft maneuver. In other words, the CG has a direct influence on the maneuverability of the aircraft.

If a very small deflection of the elevator causes "a lot of g", the efficiency of the elevator is very high. The aircraft is considered to be very sensitive to maneuver. The maneuver point is the CG, for which the elevator is infinitely effective. The CG must obviously be as far forward from the maneuver point as possible. This distance is defined by a maneuverability criteria, that determines that "at least 1° of elevator deflection is required to pull 1g load factor". This condition defines the aft CG limit in terms of maneuverability.

But the CG must not be too far forward. The maximum elevator deflection must enable at least the maximum acceptable load factor (e.g. 2.5g) to be pulled. This condition defines the forward CG limit in terms of maneuverability.

#### MAXIMUM ELEVATOR DEFLEXION AND EXTERN LOAD FACTOR

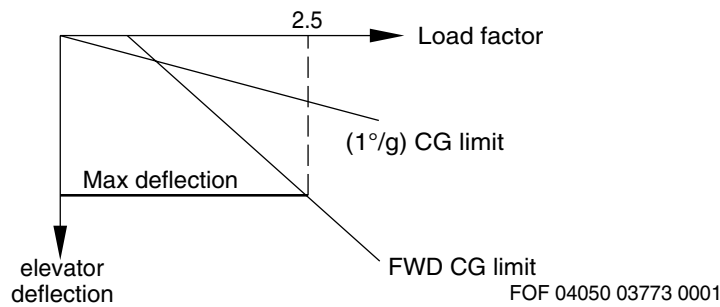

### THE CG AND TRIM POSITION

R MSN 0002-0860  
R (1)

### IN FLIGHT

In flight, on all fly-by-wire aircraft, the position of the pitch trim surface automatically adjusts in order to maintain the flight path with no deflection of the elevators.

The position of the pitch trim surfaces that is required to maintain Flight Level depends obviously on the center of gravity of the aircraft. However, it also depends on several other parameters, such as altitude, speed, aircraft weight and aircraft configuration

**TAKEOFF**

For takeoff, the pitch trim surface must be set to an appropriate position depending on the CG. This is done automatically on A340-500/600, and manually on others models.

Setting the pitch trim on ground, before takeoff, provides consistent rotation characteristics and a trimmed aircraft at  $V_2 + 10$ . The setting results from a compromise, because the rotation characteristics and the trim at  $V_2 + 10$  do not only depend on the CG, but are also a function of the flap configuration, thrust and  $V_2$ .

However, the takeoff trim setting must also be limited, in order to cover required abuse cases at takeoff. These limitations define the green band.

TAKE OFF TRIM VS AIRCRAFT CG

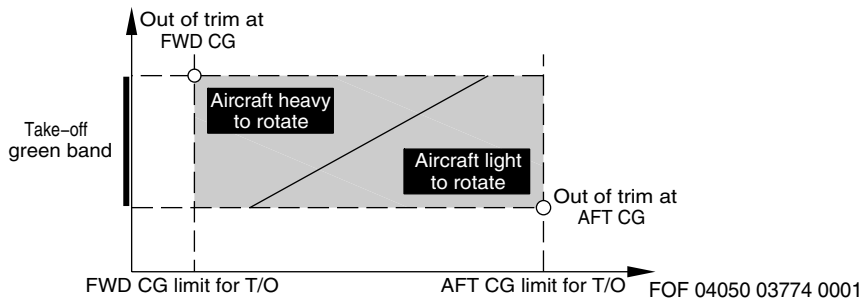

The above graph indicates the recommended TO trim, according to the CG. The TRIM/CG relationship is indicated on the pitch trim wheel scale. It applies only at takeoff.

	<b>SUPPLEMENTARY INFORMATION</b>  CENTRE OF GRAVITY	04.050
		JAN 09/07

**HIGHLIGHTS**

- (1) The specific case of A340-500/600 is now taken into account.

	<b>SUPPLEMENTARY INFORMATION</b>  TCAS	04.060
		JAN 09/07

**TECHNICAL BACKGROUND**

R MSN 0002-0860

**GENERAL**

A Traffic Alert and Collision Avoidance System (TCAS) provides the flight crew with traffic information and warnings of potential conflicts with vertical avoidance instructions. The TCAS can only detect and indicate other traffic, that is equipped with a transponder.

The ND displays the traffic information, together with:

- . The bearing and range to the intruder
- . The intruder closure rate
- . The relative altitude difference.

If the TCAS considers the intruder to be a potential collision threat, it generates a visual and aural Traffic Advisory (TA). If it considers the intruder to be real collision threat, it generates a visual and aural Resolution Advisory (RA).

**INTRUDER CLASSIFICATION**

Intruder	Display	Type of collision threat	Aural warning	Crew action
No threat traffic or others	◇    ↑	No threat	-	-
	-17(w)			
Proximate	◆    ↑	Consider as No threat	-	-
	-10(w)			
Traffic Advisory (TA)	●    ↑	Potential threat	"TRAFFIC"	Establish visual contact No evasive maneuver
	-09(a)			



	<b>SUPPLEMENTARY INFORMATION</b>		04.060
	TCAS		JAN 09/07

Resolution Advisory (RA)	■	↑	Collision threat	Preventive, e.g. "MONITORV/S"	Do not alter your flight path and keep VS out of red sector
	-06(r)			Corrective, e.g. "CLIMB"	Smoothly and firmly (0.25g) follow VSI green sector within 5s.
				Corrective, e.g. "CLIMB NOW" or "INCREASE CLIMB"	Smoothly and firmly (0.35g) follow VSI green sector within 2.5s

**OPERATIONAL RECOMMENDATION**

R MSN 0002-0860

R (1)  
**GENERAL**

The flight crew must select

- . ABV in climb (+ 9 900 feet/ - 2 700 feet)
- . ALL in cruise (+ 2 700 feet/ - 2 700 feet)
- . BELOW, if the cruise altitude is within 2 000 feet of FL 410, or in descent (+ 2 700feet/ - 9 900 feet)
- . THRT in heavy traffic terminal area
- . TA, in the case of:
  - Engine failure
  - Flight with landing gear down
  - Known nearby traffic, that is in visual contact
  - Operations at specific airports, and during specific procedures that an operator identifies as having a significant potential for not wanted and not appropriate RAs, e.g. closely spaced parallel runways, converging runways.

If a TA is generated:

- . The PF announces: "TCAS, I have controls".
- . The PF flies and announces the bearing and distance displayed on his ND.

	<b>SUPPLEMENTARY INFORMATION</b>  TCAS	04.060
		JAN 09/07

- . The PNF looks outside to get visual contact.
- . No evasive maneuver should be initiated, only on the basis of a TA.

If a RA is generated:

- . The flight crew must always follow the TCAS RA orders in the correct direction, even:
  - If they contradict the ATC instructions
  - At the maximum ceiling altitude with CLIMB, CLIMB or INCREASE CLIMB, INCREASE CLIMB TCAS RA orders
  - If it results in crossing the altitude of the intruder.
- . The PF disconnects the AP, and smoothly and firmly follows the Vertical Speed Indicator (VSI) green sector within 5 seconds, and requests that both FDs be disconnected.

Note: Both FDs must be disconnected once APs are disconnected:

- To ensure autothrust speed mode
  - To avoid possible confusion between FD bar orders and, TCAS aural and VSI orders
- . The PNF disconnects both FDs, but will not try to see intruders.
  - . The PF will avoid excessive maneuvers, and keep the Vertical Speed outside the red area of the VSI and within the green area. If necessary, the PF must use the full speed range between Valpha max and Vmax.
  - . The PNF must notify ATC.
  - . The flight crew should never maneuver in the opposite direction of the RA, because TCAS maneuvers are coordinated.
  - . In final approach, i.e. "CLIMB", "CLIMB NOW", "INCREASE CLIMB", the flight crew will initiate a go-around.

When clear of conflict:

- . The flight crew must resume normal navigation, in accordance with ATC clearance, and using the AP, as required.

#### **FAA OPERATIONAL RECOMMENDATIONS**

The pilots should follow RAs unless they believe it is unsafe to do so or they have definitive visual acquisition of the intruding aircraft. If a pilot makes the decision not to follow a RA, he should be aware that the intruder may be TCAS equipped and may be manoeuvring toward his aircraft in response to a coordinated RA.

Pilots should comply with the vertical speed limitations prescribed in the Airmans information manual during the last 2000 ft of climb or descent. In particular, pilots should limit vertical speeds to 1500 ft/mn during the last 2000 ft of a climb or

	<b>SUPPLEMENTARY INFORMATION</b>	04.060
	TCAS	JAN 09/07

descent, especially when they are aware of traffic that is converging in altitude and intending to level off 1000 ft above or below the pilots assigned altitude.

 <b>AIRBUS</b> <b>A330/A340</b> FLIGHT CREW TRAINING MANUAL	<b>SUPPLEMENTARY INFORMATION</b>  TCAS	04.060
		JAN 09/07

**HIGHLIGHTS**

- (1) Harmonization of call out with FCOM

	<b>SUPPLEMENTARY INFORMATION</b>  USE OF RADAR	04.070
		JAN 09/07

R MSN 0002-0860

**GENERAL**

The weather radar has two main functions:

- . Weather detection
- . Mapping.

Weather detection is the primary function. For weather detection, the radar detects precipitation droplets. The strength of the echo is in proportion to the droplet size, composition and quantity (e.g. the reflection of water particles is five times greater than ice particles of the same size). Therefore, the weather radar does not detect weather that has small droplets (e.g. clouds or fog), or that does not have droplets (e.g. clear air turbulence).

Mapping is the secondary function. For mapping, the echo takes into account the difference between incoming and outgoing signals. Any significant difference in the signal is easily mapped (e.g. mountains or cities), but a small difference in the signal is not mapped (e.g. calm sea or even ground).

**FUNCTIONS**

R MSN 0002-0529 0531-0554 0556-0586 0588-0633 0635-0654 0656-0660 0662-0677 0679-0692 0694-0712 0714-0717 0719 0721 0723-0725 0727 0729-0731 0734 0736-0744 0746-0748 0752-0754 0757-0758 0760-0761 0764-0766 0768-0770 0772 0774 0776 0779 0783 0786-0789 0792 0795 0798 0801-0805 0809 0811 0813 0819-0820 0822-0824 0826 0828-0829 0832-0835 0837-0838 0844-0846 0848-0850 0852 0854-0855

The flight crew can use the following to operate the radar:

**TILT**

"Tilt" is the angle between the antenna radar and the horizon, irrespective of the aircraft's pitch and bank angles. The antenna stabilizes by using IRS data.

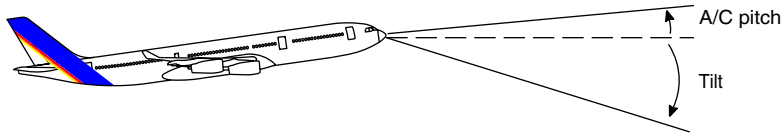

FOF 04070 04613 0001

To help avoid weather, it is important to effectively manage the tilt, taking into account the flight phase and the ND range. Usually, it is the appropriate tilt value that provides ground returns on the top of the ND.

In case of overscanning, a cell may not be detected or may be underestimated, when the radar beam scans the upper part of the cell. This occurs because, at high altitude, this cell may have ice particles, and therefore the reflection of these particles is weak.

If AUTO TILT function is installed, selecting AUTO ensures a proper tilt management along the flight.

### **GAIN**

Gain control is mostly used in AUTO/CAL mode. The detection or evaluation of cells will always start in AUTO/CAL gain mode.

However, the gain may be manually tuned to detect the strongest part of a cell displayed in red on the ND. If the gain is slowly reduced, the red areas (level 3 return) will slowly become yellow areas (level 2 return), and the yellow areas will become green areas (level 1). The last part of the cell to turn yellow is the strongest area.

The gain must then be reset to AUTO/CAL mode.

### **MODE**

The operation modes are WX, WX+T, TURB, MAP.

WX+T or TURB modes are used to locate the wet turbulence area.

TURB mode detects wet turbulence within 40 nm, and is not affected by the gain.

TURB mode should be used to isolate turbulence from precipitation.

### **GCS (IF INSTALLED)**

The Ground Clutter Suppression (GCS) operates in WX mode, and inhibits the ground echoes on the ND.

It is sometimes difficult to differentiate between weather and ground returns. A change in tilt rapidly changes the shape and color of ground returns and eventually makes them disappear. This is not the case for weather.

**RCT (IF INSTALLED)**

The React (RCT) function is used temporarily to help detect weather or buildups beyond of the weather already detected.

**PWS**

(Refer to the FCTM 04.010 on Adverse Weather)

R MSN 0530 0555 0587 0634 0655 0661 0678 0693 0713 0718 0720 0722 0726 0728  
0732-0733 0735 0745 0749-0751 0755-0756 0759 0762-0763 0767 0771 0773 0775 0777-0778  
0780-0782 0784-0785 0790-0791 0793-0794 0796-0797 0799-0800 0806-0807 0810 0812  
0814-0818 0821 0825 0827 0830-0831 0836 0839-0843 0847 0851 0853 0857-0860

The flight crew can use the following to operate the radar:

**TILT**

"Tilt" is the angle between the antenna radar and the horizon, irrespective of the aircraft's pitch and bank angles. The antenna stabilizes by using IRS data.

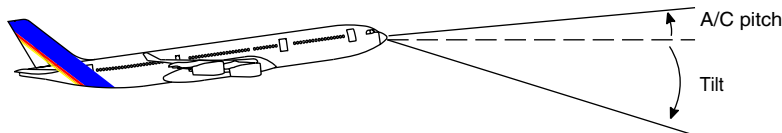

FOF 04070 04613 0001

To help avoid weather, it is important to effectively manage the tilt, taking into account the flight phase and the ND range. Usually, it is the appropriate tilt value that provides ground returns on the top of the ND.

	<b>SUPPLEMENTARY INFORMATION</b>	04.070
	USE OF RADAR	JAN 09/07

In case of overscanning, a cell may not be detected or may be underestimated, when the radar beam scans the upper part of the cell. This occurs because, at high altitude, this cell may have ice particles, and therefore the reflection of these particles is weak.

Selecting AUTO ensures a proper tilt management along the flight.

*Note: In cruise, MULTISCAN function provides a large view of the weather ahead, ie display of weather cells located on and below aircraft path. Before envisaging a route change in front of an ambiguous or unexpected weather display, the crew should confirm the potential conflict with aircraft path, using temporarily manual tilt.*

### **GAIN**

Manual gain selection (+8) must be used when MULTISCAN selector is set to AUTO.

However, the gain may be tuned to detect the strongest part of a cell displayed in red on the ND. If the gain is slowly reduced, the red areas (level 3 return) will slowly become yellow areas (level 2 return), and the yellow areas will become green areas (level 1). The last part of the cell to turn yellow is the strongest area.

The gain must then be reset to +8.

### **MODE**

The operation modes are WX, WX+T, TURB, MAP.

WX+T or TURB modes are used to locate the wet turbulence area.

TURB mode detects wet turbulence within 40 nm, and is not affected by the gain.

TURB mode should be used to isolate turbulence from precipitation.

### **GCS (IF INSTALLED)**

The Ground Clutter Suppression (GCS) operates in WX mode, and inhibits the ground echoes on the ND.

It is sometimes difficult to differentiate between weather and ground returns. A change in tilt rapidly changes the shape and color of ground returns and eventually makes them disappear. This is not the case for weather.

### **RCT (IF INSTALLED)**

The React (RCT) function is used temporarily to help detect weather or buildups beyond of the weather already detected.



	<b>SUPPLEMENTARY INFORMATION</b>  USE OF RADAR	04.070
		JAN 09/07

**PWS**

(Refer to the FCTM 04.010 on Adverse Weather)

R MSN 0002-0370 0372-0375 0377-0382 0384-0390 0392-0409 0411-0415 0418-0425 0427-0448  
 0450-0470 0472-0529 0532-0533 0535-0543 0545-0546 0548-0554 0556 0558-0571 0573-0574  
 0576-0581 0583-0586 0588 0591-0600 0603 0605 0609-0610 0612-0614 0616 0618 0620-0621  
 0624-0625 0627-0629 0631-0633 0635-0636 0642 0644-0645 0647-0650 0652-0654 0656-0658  
 0660 0662-0670 0673-0674 0677 0679 0681-0684 0686-0690 0692 0695-0698 0700-0701  
 0703-0705 0709-0712 0715-0717 0719 0721 0724 0729-0730 0734 0737-0743 0746-0748  
 0757-0758 0760-0761 0766 0770 0776 0779 0783 0786 0788-0789 0792 0795 0798  
 0801-0802 0809 0811 0813 0819-0820 0822 0824 0826 0828-0829 0832-0834 0837 0846  
 0848-0850 0852 0854-0855

**OPERATIONAL RECOMMENDATIONS FOR WEATHER DETECTION**

FLIGHT PHASE	DETECTION AND MONITORING PROCEDURES	COMMENTS
TAXI	clear on parking area, set ND to lowest range, TILT DOWN then UP; Check appearance/disappearance of ground returns.	Radar check (away from people).
TAKEOFF	If weather is suspected, SLOWLY SCAN up to + 15°, then TILT + 4°.	Scanning along departure path.
CLIMB	To avoid OVERSCANNING, TILT DOWNWARD as the A/C climbs, and maintain GND RETURNS ON TOP OF ND.	TILT angle function of altitude and ND RANGE.
CRUISE	Use TILT slightly NEGATIVE to maintain ground returns on top of ND: Range 320 TILT $\cong$ 1 DN Range 160 TILT $\cong$ 1,5 DN Range 80 TILT $\cong$ 3,5 DN Range 40 TILT $\cong$ 6 DN Use TURB to ISOLATE Turbulence – GAIN to AUTO.	No ground returns beyond line of view. Dnm = 1,23 $\sqrt$ ALT ft FL 370 D 240nm Poor ground returns over calm sea / even ground.
DESCENT	During DES, TILT UPWARD approximately + 1° / 10000 ft in higher altitudes, then + 1°/5000 ft below 15000 ft.	
APPROACH	TILT + 4°.	To avoid ground returns.

FOF 04070 04618 0001

*Note: It is difficult to differentiate between weather returns and ground returns: A change in TILT causes the shape and color of ground returns to change rapidly. These ground returns eventually disappear. This is not the case for weather returns.*

	<b>SUPPLEMENTARY INFORMATION</b>	04.070
	USE OF RADAR	JAN 09/07

R MSN 0371 0376 0383 0391 0410 0416-0417 0426 0449 0471 0531 0534 0544 0547 0557  
0572 0575 0582 0590 0601-0602 0604 0606-0608 0611 0615 0617 0619 0622-0623 0626  
0630 0637-0641 0643 0646 0651 0659 0671-0672 0675-0676 0680 0685 0691 0694 0699  
0702 0706-0708 0714 0723 0725 0727 0731 0736 0744 0752-0754 0764-0765 0768-0769  
0772 0774 0787 0803-0805 0823 0835 0838 0844-0845

**OPERATIONAL RECOMMENDATIONS FOR WEATHER DETECTION**

FLIGHT PHASE	DETECTION AND MONITORING PROCEDURES	COMMENTS
TAXI	Clear on parking area, set ND to lowest range, TILT DOWN then UP; Check appearance/disappearance of ground returns. Reselect AUTO after scanning.	Radar check (away from people)
TAKE OFF	If weather is suspected, SLOWLY SCAN up to + 15°, then reselect AUTO.	Scanning along departure path
IN FLIGHT	Use TURB to ISOLATE Turbulence GAIN to AUTO	Poor ground return over calm sea / even ground

*Note: Weather and ground returns are difficult to differentiate: a change in TILT rapidly changes the shape and color of ground returns and eventually cause them to disappear which is not the case for weather.*

R MSN 0530 0555 0587 0634 0655 0661 0678 0693 0713 0718 0720 0722 0726 0728  
0732-0733 0735 0745 0749-0751 0755-0756 0759 0762-0763 0767 0771 0773 0775 0777-0778  
0780-0782 0784-0785 0790-0791 0793-0794 0796-0797 0799-0800 0806-0807 0810 0812  
0814-0818 0821 0825 0827 0830-0831 0836 0839-0843 0847 0851 0853 0857-0860

**OPERATIONAL RECOMMENDATIONS FOR WEATHER DETECTION**

FLIGHT PHASE	DETECTION AND MONITORING PROCEDURES	COMMENTS
--------------	-------------------------------------	----------

	<b>SUPPLEMENTARY INFORMATION</b>	04.070
	USE OF RADAR	JAN 09/07

TAXI	Clear on parking area, set ND to lowest range, TILT DOWN then UP; Check appearance/disappearance of ground returns. Reselect AUTO after scanning.	Radar check (away from people)
TAKE OFF	If weather is suspected, SLOWLY SCAN up to + 15 °, then reselect AUTO.	Scanning along departure path
IN FLIGHT	Use TURB to ISOLATE Turbulence	Poor ground return over calm sea / even ground

Note:

1. Gain must be manually set to +8, when MULTISCAN selector is set to AUTO
2. MULTISCAN AUTO mode provides an efficient ground clutter rejection. During operation in good or non significant weather, no weather pattern will be displayed on ND's. In such situation, the crew ascertains correct radar operation, using temporarily MANUAL TILT.
3. The crew monitors weather radar display in AUTO, and confirms any ambiguous or unexpected weather display using manual tilt according to standard techniques.

R MSN 0002-0860

**OTHER OPERATIONNAL RECOMMENDATION**

**WEATHER AVOIDANCE**

- . When weather is suspected, scan for it by varying the radar tilt. If AUTOTILT or MULTISCAN function is available, reselect AUTO after scanning.
- . Do not underestimate a thunderstorm, even if echo is weak (only wet parts are detected)
- . Avoid all red + magenta cells by at least 20 nm
- . Deviate upwind instead of downwind (less probability of turbulence or hail)

- . Do not attempt to fly below a storm even visual (turbulence, shear, altimetry)
- . Use TURB detection to isolate turbulence from precipitation
- . There may be severe turbulence, up to 5 000 ft above a cell
- . Storms with tops above 35 000 ft are hazardous
- . Frequent and vivid lightning indicates a high probability of severe turbulence.

**WEATHER PENETRATION**

In the case of storm penetration, the flight crew must take full advantage of the radar. For flight crew guidelines, in the case of turbulence, refer to the FCTM section on ADVERSE WEATHER.

**MAPPING**

TILT and GAIN have to be adjusted harmoniously, because the ground returns vary greatly with the angle of the radar beam which illuminates them.

- . Use MAP to detect PROMINENT TERRAIN (mountain, city, and coastline)
- . Adjust TILT and GAIN - Mapping coverage varies with tilt and aircraft altitude.

TILT ANGLE	AREA SCANNED AT FL 330
3 ° DN	72 nm to 190 nm
5 ° DN	47 nm to 190 nm
7 ° DN	36 nm to 70 nm
10 ° DN	26 nm to 41 nm

**However, flight crew should NOT USE the weather radar as a terrain avoidance system.**